

Introduction to BPMN

Stephen A. White, IBM Corporation

Abstract

This paper is intended to provide a high-level overview and introduction to the Business Process Modeling Notation (BPMN). The context and general uses for BPMN will be provided as a supplement to the technical details defined in the BPMN 1.0 Specification, which has been recently completed and released to the public. The basics of the BPMN notation will be described—that is, the types of graphical objects that comprise the notation and how they work together as part of a Business Process Diagram. Also discussed will be the different uses of BPMN, including how levels of precision affect what a modeler will include in a diagram. Finally, the value in using BPMN as a standard notation will be defined and the future of BPMN outlined.

What Is BPMN?

The Business Process Management Initiative (BPMI) has developed a standard Business Process Modeling Notation (BPMN). The BPMN 1.0 specification was released to the public in May, 2004. This specification represents more than two years of effort by the BPMI Notation Working Group. The primary goal of the BPMN effort was to provide a notation that is readily understandable by all business users, from the business analysts that create the initial drafts of the processes, to the technical developers responsible for implementing the technology that will perform those processes, and finally, to the business people who will manage and monitor those processes. BPMN will also be supported with an internal model that will enable the generation of executable BPEL4WS. Thus, BPMN creates a standardized bridge for the gap between the business process design and process implementation.

BPMN defines a Business Process Diagram (BPD), which is based on a flowcharting technique tailored for creating graphical models of business process operations. A Business Process Model, then, is a network of graphical objects, which are activities (i.e., work) and the flow controls that define their order of performance.

BPMN Basics

A BPD is made up of a set of graphical elements. These elements enable the easy development of simple diagrams that will look familiar to most business analysts (e.g., a flowchart diagram). The elements were chosen to be distinguishable from each other and to utilize shapes that are familiar to most modelers. For example, activities are rectangles and decisions are diamonds. It should be emphasized that one of the drivers for the development of BPMN is to create a simple mechanism for creating business process models, while at the same time being able to handle the complexity inherent to business processes. The approach taken to handle these two conflicting requirements was to organize the graphical aspects of the notation into specific categories. This provides a small set of notation categories so that the reader of a BPD can easily recognize the basic types of

elements and understand the diagram. Within the basic categories of elements, additional variation and information can be added to support the requirements for complexity without dramatically changing the basic look-and-feel of the diagram. The four basic categories of elements are:

- Flow Objects
- Connecting Objects
- Swimlanes
- Artifacts

Flow Objects

A BPD has a small set of (three) core elements, which are the *Flow Objects*, so that modelers do not have to learn and recognize a large number of different shapes. The three Flow Objects are:



Event	An <i>Event</i> is represented by a circle and is something that “happens” during the course of a business process. These Events affect the flow of the process and usually have a cause (trigger) or an impact (result). Events are circles with open centers to allow internal markers to differentiate different triggers or results. There are three types of Events, based on when they affect the flow: <i>Start</i> , <i>Intermediate</i> , and <i>End</i> (see the figures to the right, respectively).	
Activity	An <i>Activity</i> is represented by a rounded-corner rectangle (see the figure to the right) and is a generic term for work that company performs. An Activity can be atomic or non-atomic (compound). The types of Activities are: <i>Task</i> and <i>Sub-Process</i> . The Sub-Process is distinguished by a small plus sign in the bottom center of the shape.	
Gateway	A <i>Gateway</i> is represented by the familiar diamond shape (see the figure to the right) and is used to control the divergence and convergence of Sequence Flow. Thus, it will determine traditional decisions, as well as the forking, merging, and joining of paths. Internal Markers will indicate the type of behavior control.	

Table 1: Core BPD Flow Objects

Connecting Objects

The Flow Objects are connected together in a diagram to create the basic skeletal structure of a business process. There are three *Connecting Objects* that provide this function. These connectors are:

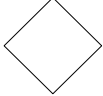

Sequence Flow	A <i>Sequence Flow</i> is represented by a solid line with a solid arrowhead (see the figure to the right) and is used to show the order (the sequence) that activities will be performed in a Process. Note that the term "control flow" is generally not used in BPMN.	
Message Flow	A <i>Message Flow</i> is represented by a dashed line with an open arrowhead (see the figure to the right) and is used to show the flow of messages between two separate Process Participants (business entities or business roles) that send and receive them. In BPMN, two separate Pools in the Diagram will represent the two Participants.	
Association	An <i>Association</i> is represented by a dotted line with a line arrowhead (see the figure to the right) and is used to associate data, text, and other Artifacts with flow objects. Associations are used to show the inputs and outputs of activities.	

Table 2: BPD Connecting Elements

For modelers who require or desire a low level of precision to create process models for documentation and communication purposes, the core elements plus the connectors will provide the ability to easily create understandable diagrams (see Figure 1).

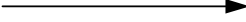
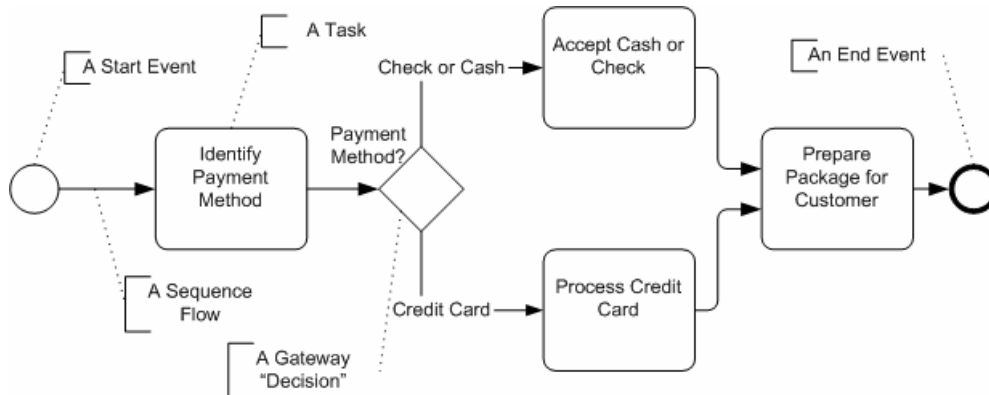

Figure 1: An Example of a Simple Business Process

For modelers who require a higher level of precision to create process models, which will be subject to detailed analysis or will be managed by Business Process Management System (BPMS), additional details can be added to the core elements and shown through internal markers (see Figure 2).

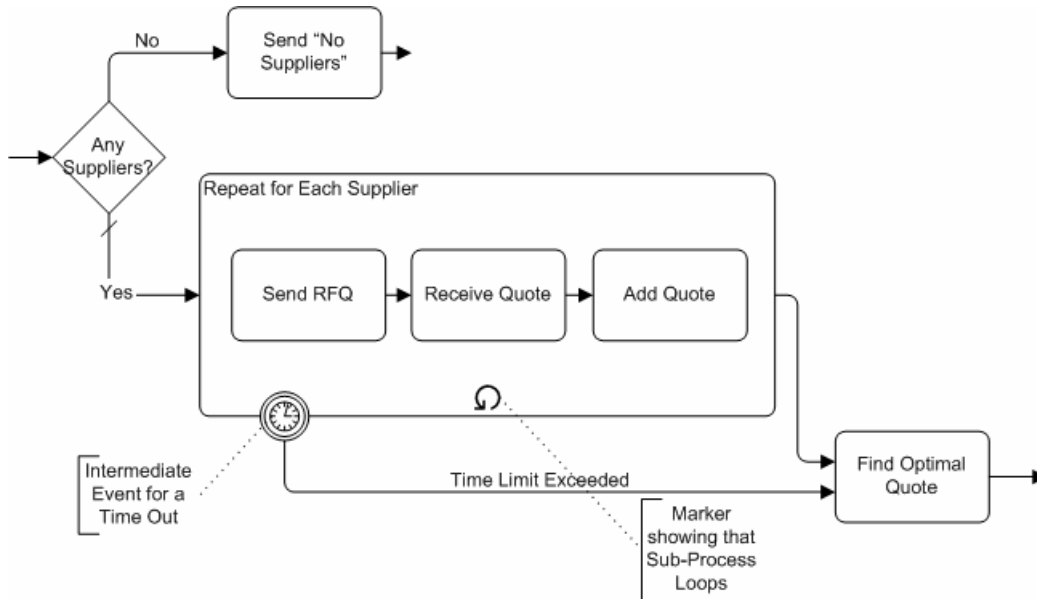

Figure 2: A Segment of a Process with more Details

Swimlanes

Many process modeling methodologies utilizes the concept of *swimlanes* as a mechanism to organize activities into separate visual categories in order to illustrate different functional capabilities or responsibilities. BPMN supports swimlanes with two main constructs. The two types of BPD swimlane objects are:

Pool A *Pool* represents a Participant in a Process. It is also acts as a graphical container for partitioning a set of activities from other Pools (see the figure to the right), usually in the context of B2B situations.



Lane A *Lane* is a sub-partition within a Pool and will extend the entire length of the Pool, either vertically or horizontally (see the figure to the right). Lanes are used to organize and categorize activities.

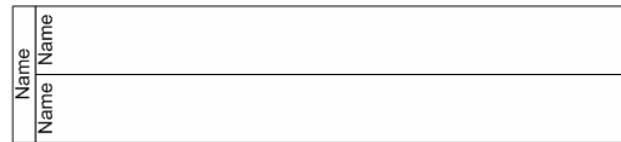

Table 3: BPD Swimlane Objects

Pools are used when the diagram involves two separate business entities or participants (see Figure 3) and are physically separated in the diagram. The activities within separate Pools are considered self-contained Processes. Thus, the Sequence Flow may not cross the boundary of a Pool. Message Flow is defined as being the mechanism to show the communication between two participants, and, thus, must connect between two Pools (or the objects within the Pools).

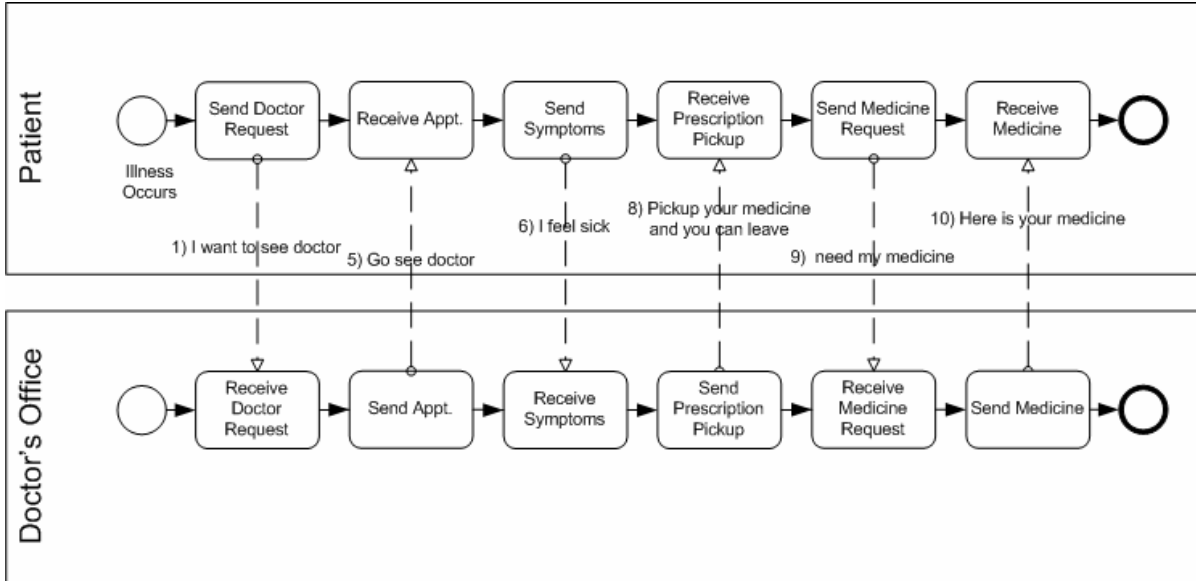

Figure 3: An Example of a BPD with Pools

Lanes are more closely related to the traditional swimlane process modeling methodologies. Lanes are often used to separate the activities associated with a specific company function or role (see Figure 4). Sequence Flow may cross the boundaries of Lanes within a Pool, but Message Flow may not be used between Flow Objects in Lanes of the same Pool.

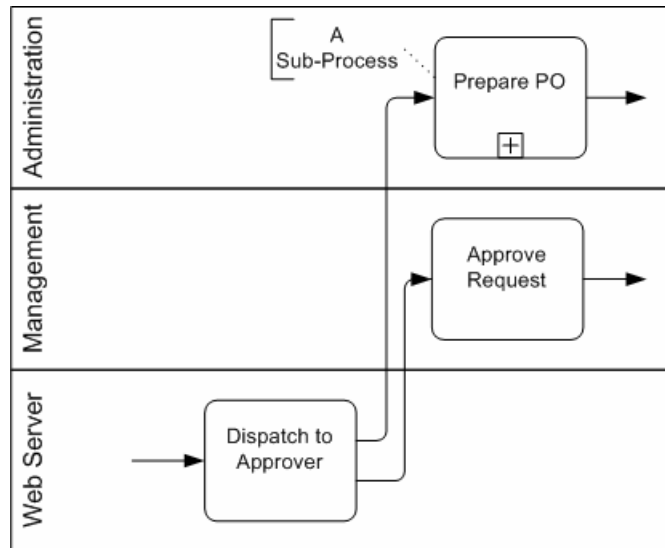

Figure 4: A Segment of a Process with Lanes

Artifacts

BPMN was designed to allow modelers and modeling tools some flexibility in extending the basic notation and in providing the ability to additional context appropriate to a specific modeling situation, such as for a vertical market (e.g., insurance or banking). Any number of *Artifacts* can be added to a diagram as appropriate for the context of the business processes being modeled. The current version of the BPMN specification pre-defines only three types of BPD Artifacts, which are:



Data Object	<i>Data Objects</i> are a mechanism to show how data is required or produced by activities. They are connected to activities through Associations.	
Group	A <i>Group</i> is represented by a rounded corner rectangle drawn with a dashed line (see the figure to the right). The grouping can be used for documentation or analysis purposes, but does not affect the Sequence Flow.	
Annotation	<i>Annotations</i> are a mechanism for a modeler to provide additional text information for the reader of a BPMN Diagram (see the figure to the right).	

Table 4: BPD Artifact Elements

Modelers can create their own types of Artifacts, which add more details about how the process is performed—quite often to show the inputs and outputs of activities in the Process. However, the basic structure of the process, as determined by the Activities, Gateways, and Sequence Flow, are not changed with the addition of Artifacts in the diagram; as you can see by comparing Figure 4 and Figure 5.

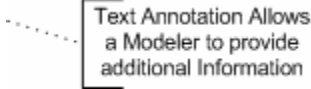
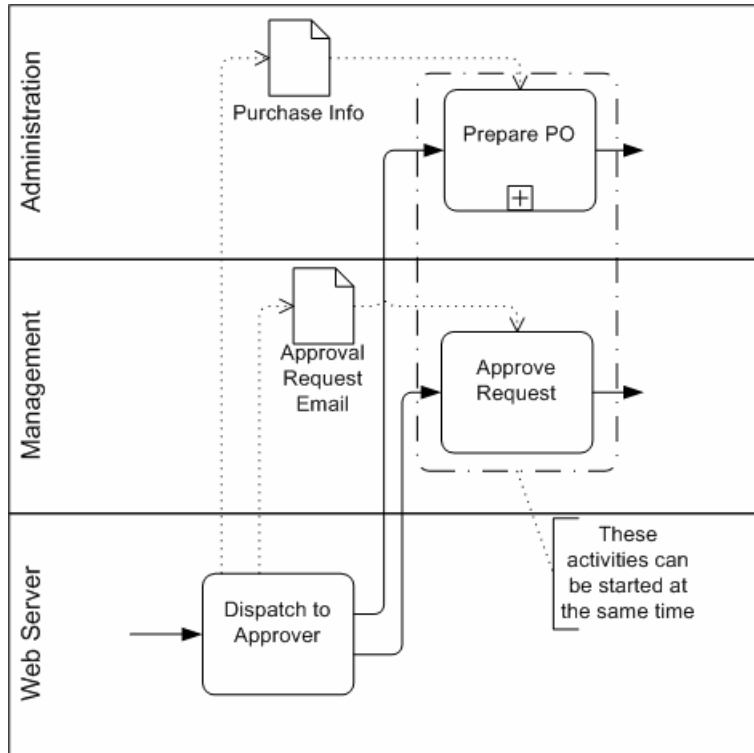

Figure 5: A Segment of a Process with Data Objects, Groups, and Annotations

General uses of BPMN

Business process modeling is used to communicate a wide variety of information to different audiences. BPMN is designed to cover many types of modeling and allows the creation of process segments as well as end-to-end business processes, at different levels of fidelity. Within the variety of process modeling objectives, there are two basic types of models that can be created with a BPD:

- Collaborative (Public) B2B Processes
- Internal (Private) Business Processes

Collaborative B2B Processes

A *collaborative B2B process* depicts the interactions between two or more business entities. The diagrams for these types of processes are generally from a global point of view. That is, they do not take the view of any particular participant, but show the interactions between the participants. The interactions are depicted as a sequence of activities and the message exchange patterns between the participants. The activities for the collaboration participants can be considered the “touch-points” between the participants; thus, the process defines the interactions that are visible to the public for each participant. When looking at the process shown in only one Pool (i.e., for one participant), public process is also called an *abstract* process. The actual (internal) processes are likely to have more activities and detail than what is shown in the collaborative B2B processes.

Figure 3, above, is repeated in Figure 6 to show an example of a collaborative B2B process.

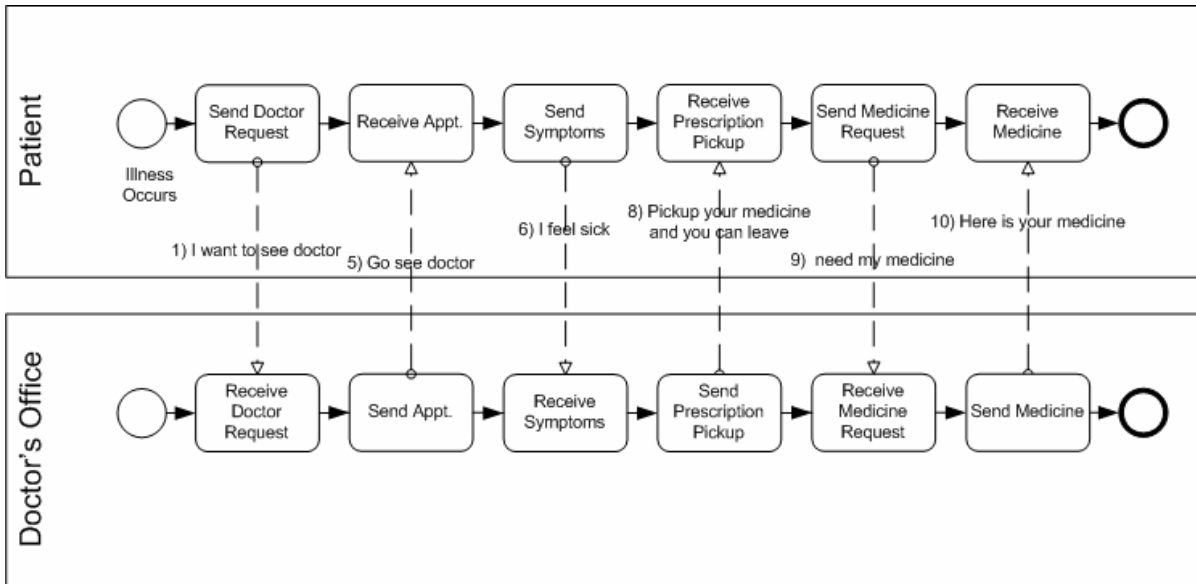

Figure 6: An Example of a Collaborative B2B Process

Internal business processes

An *internal business process* will generally focus on the point of view of a single business organization. Although internal processes often show interactions with external participants, they define the activities that are not generally visible to the public and are, therefore, private activities. If swimlanes are used then an internal business process will be contained within a single Pool. The Sequence Flow of the Process is therefore contained within the Pool and cannot cross the boundaries of the Pool. Message Flow can cross the Pool boundary to show the interactions that exist between separate internal business processes. Thus, a single Business Process Diagram may show multiple private business processes.

Different Purposes – Different levels of precision

The modeling of business processes often starts with capturing high-level activities and then drilling down to lower levels of detail within separate diagrams. There may be multiple levels of diagrams, depending on the methodology used for model development. However, BPMN is independent of any specific process modeling methodology.

Figure 7 shows an example of a high level process, captured for a BPMN case study, which is basically a series of Sub-Processes with three decision points in the Process.

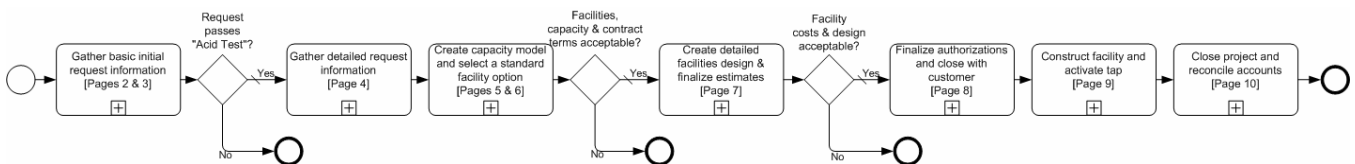

Figure 7: High-level Business Process Example

Figure 8 shows the details of the first Sub-Process of Figure 7. This diagram employs two (2) Pools; one for the customer and one for the company providing the service. Note that this diagram shows the internal business process for the company and shows an abstract process for the customer (i.e.,

the customer process only includes the activities used for communicating through Message Flow to the company). The activities within the company are partitioned by Lanes to show the departments or roles responsible for their performance (e.g., System Coordinator, Business Development, Legal, and Retail).

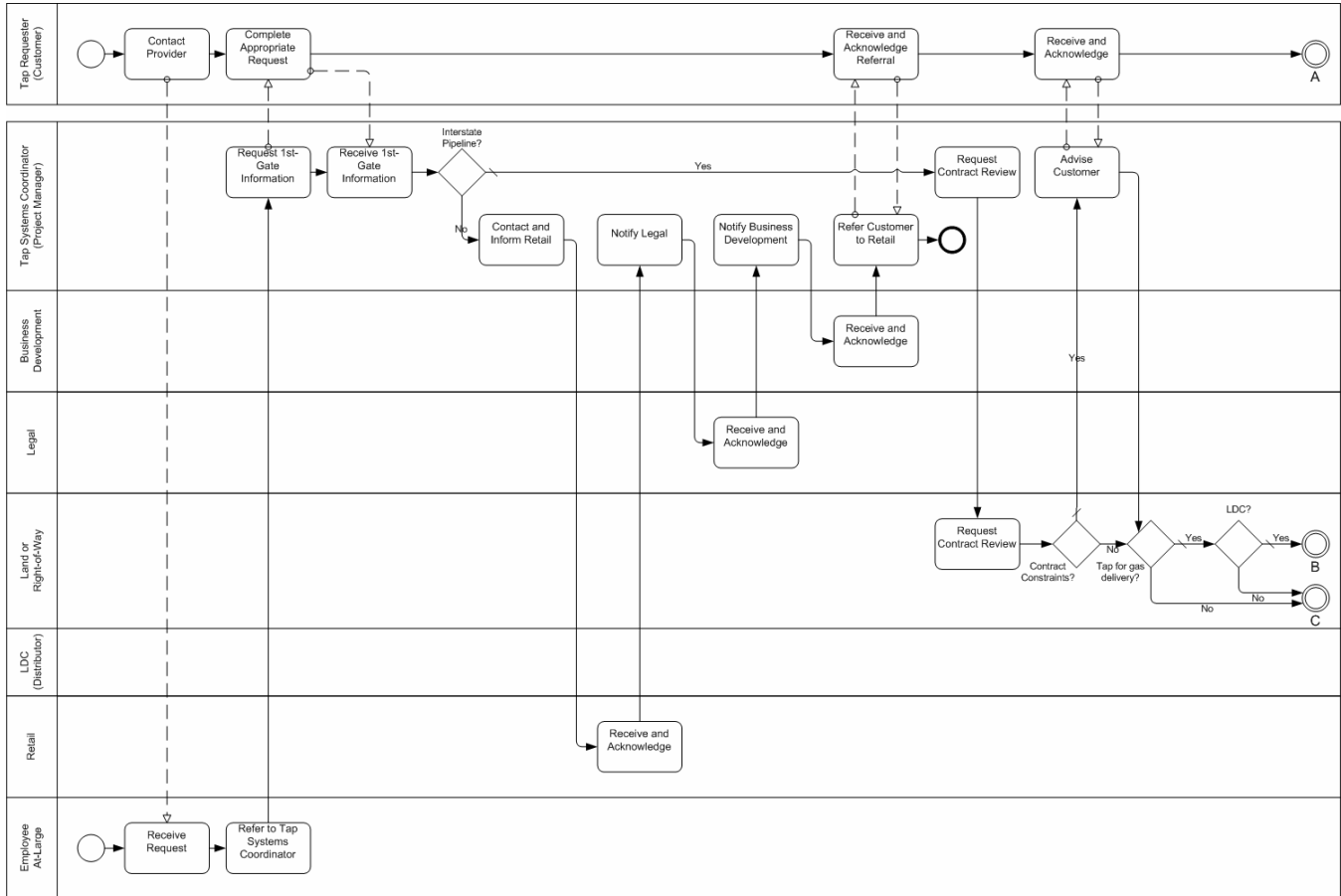

Figure 8: Lower-level Business Process for the High-Level Example

What is the Value of modeling in BPMN?

The membership of the BPMI Notation Working Group represents a large segment of the business process modeling community and they have come to a consensus and present BPMN as the standard business process modeling notation. The development of BPMN is an important step in reducing the fragmentation that exists with the myriad of process modeling tools and notations. The BPMI Notation Working Group has brought forth expertise and experience with many existing notations and has sought to consolidate the best ideas from these divergent notations into a single standard notation. Examples of other notations or methodologies that were reviewed are: UML Activity Diagram, UML EDOC Business Processes, IDEF, ebXML BPSS, Activity-Decision Flow (ADF) Diagram, RosettaNet, LOVeM, and Event-Process Chains (EPCs). This fragmentation has hampered the wide-spread adoption of inter-operable business process management systems. A well-supported standard modeling notation will reduce confusion among business and IT end-users.

Another factor that drove the development of BPMN is that, historically, business process models developed by business people have been technically separated from the process representations required by systems designed to implement and execute those processes. Thus, there was a need to manually translate the original business process models to the execution models. Such translations are subject to errors and make it difficult for the process owners to understand the evolution and the performance of the processes they developed.

Mapping a BPMN Diagram to BPEL4WS

To help alleviate the modeling technical gap, a key goal in the effort to develop BPMN was to create a bridge from the business-oriented process modeling notation to IT-oriented execution languages that will implement the processes within a business process management system. The graphical objects of BPMN, supported by a rich set of object attributes, have been mapped to the Business Process Execution Language for Web Services (BPEL4WS v1.1), the defacto standard for process execution. Figure 9 provides an example of a segment of a business process and marks the mapping to the BPEL4WS execution elements.

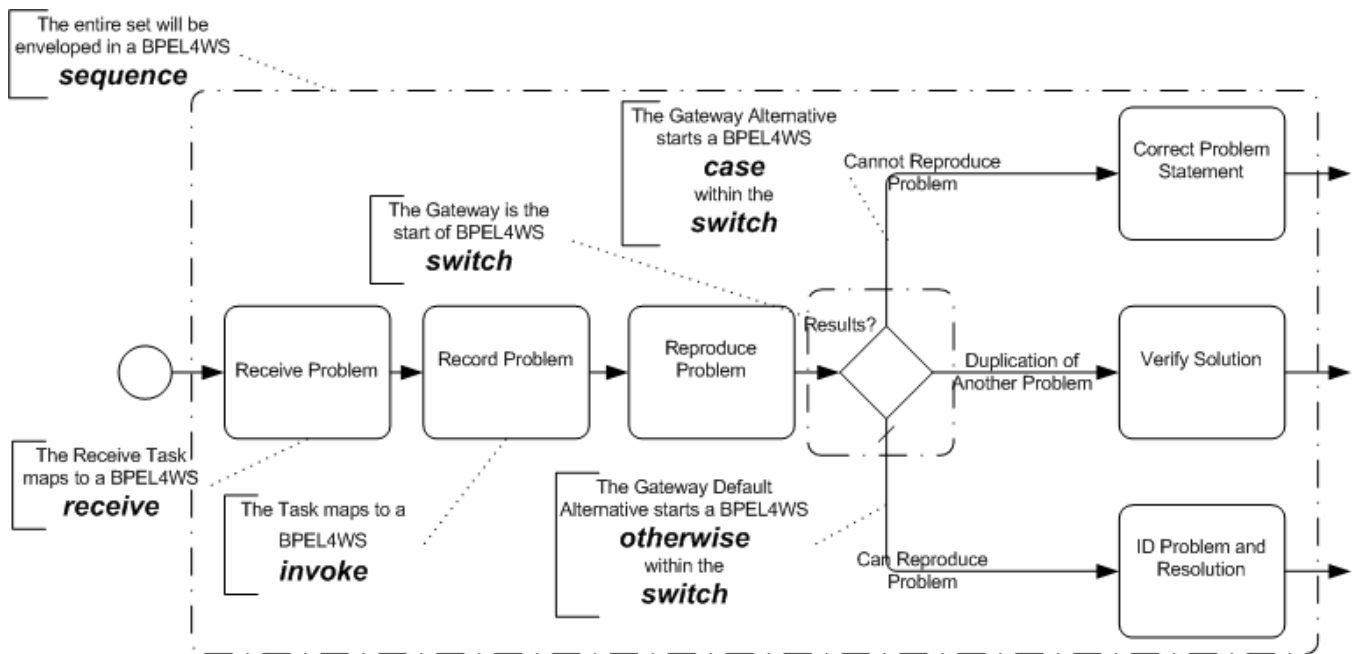

Figure 9: A BPD with Annotations to Show the Mapping to BPEL4WS

Future of BPMN

Even though the BPMN specification is currently at a version 1.0, many companies have committed to supporting and implementing the specification (see the BPMP press release, dated March 2, 2004: <http://www.bpmp.org/PR.esp?id=301>). The near future will provide a great deal of vendor and end-user experience with BPMN. Such experience will provide valuable feedback for fine-tuning the details of the BPMN specification, particularly concerning the mapping to BPEL4WS. While a major revision of BPMN is not expected soon, a maintenance version (e.g., version 1.1) can be expected to be completed in about 9 to 12 months. In addition to a maintenance release, there is likely to be efforts within BPMP to standardize sets of Artifacts to support general business modeling and vertical business domains (e.g., insurance, manufacturing, and finance). In addition, there is likely to be efforts to fit BPMN into a larger context of higher-level business modeling, which includes, for example, the modeling of business rules and business strategy.

BPMP is not a formal standards organization; rather, BPMP is an organization that innovates and incubates key specifications to support the development of BPM systems. Therefore, BPMN will eventually be passed on to an organization to formalize its status as standard. The OMG is a likely candidate to eventually take in the BPMN standards and there have been discussions between BPMP and the OMG to facilitate this transfer in the future. Considering that the OMG is currently developing UML, which includes Activity Diagrams, it is possible that a consolidation of BPMN Business Process Diagrams and UML Activity Diagrams will take place.