Business Process Modeling Notation Specification

This OMG document replaces the submission document and the draft adopted specification (drc/06-01-01). It is an OMG Final Adopted Specification, which has been approved by the OMG board and technical plenaries, and is currently in the finalization phase. Comments on the content of this document are welcomed, and should be directed to *issues@omg.org* by March 6, 2006.

You may view the pending issues for this specification from the OMG revision issues web page <http://www.omg.org/issues/>; however, at the time of this writing there were no pending issues.

The FTF Recommendation and Report for this specification will be published on May 5, 2006. If you are reading this after that date, please download the available specification from the OMG Specifications Catalog.

Business Process Modeling Notation (BPMN) Specification

Final Adopted Specification

dtc/06-02-01



OBJECT MANAGEMENT GROUP

Copyright © 2004, BPMI.org
Copyright © 2006, Object Management Group

USE OF SPECIFICATION - TERMS, CONDITIONS & NOTICES

The material in this document details an Object Management Group specification in accordance with the terms, conditions and notices set forth below. This document does not represent a commitment to implement any portion of this specification in any company's products. The information contained in this document is subject to change without notice.

LICENSES

The companies listed above have granted to the Object Management Group, Inc. (OMG) a nonexclusive, royalty-free, paid up, worldwide license to copy and distribute this document and to modify this document and distribute copies of the modified version. Each of the copyright holders listed above has agreed that no person shall be deemed to have infringed the copyright in the included material of any such copyright holder by reason of having used the specification set forth herein or having conformed any computer software to the specification.

Subject to all of the terms and conditions below, the owners of the copyright in this specification hereby grant you a fully-paid up, non-exclusive, nontransferable, perpetual, worldwide license (without the right to sublicense), to use this specification to create and distribute software and special purpose specifications that are based upon this specification, and to use, copy, and distribute this specification as provided under the Copyright Act; provided that: (1) both the copyright notice identified above and this permission notice appear on any copies of this specification; (2) the use of the specifications is for informational purposes and will not be copied or posted on any network computer or broadcast in any media and will not be otherwise resold or transferred for commercial purposes; and (3) no modifications are made to this specification. This limited permission automatically terminates without notice if you breach any of these terms or conditions. Upon termination, you will destroy immediately any copies of the specifications in your possession or control.

PATENTS

The attention of adopters is directed to the possibility that compliance with or adoption of OMG specifications may require use of an invention covered by patent rights. OMG shall not be responsible for identifying patents for which a license may be required by any OMG specification, or for conducting legal inquiries into the legal validity or scope of those patents that are brought to its attention. OMG specifications are prospective and advisory only. Prospective users are responsible for protecting themselves against liability for infringement of patents.

GENERAL USE RESTRICTIONS

Any unauthorized use of this specification may violate copyright laws, trademark laws, and communications regulations and statutes. This document contains information which is protected by copyright. All Rights Reserved. No part of this work covered by copyright herein may be reproduced or used in any form or by any means--graphic, electronic, or mechanical, including photocopying, recording, taping, or information storage and retrieval systems--without permission of the copyright owner.

DISCLAIMER OF WARRANTY

WHILE THIS PUBLICATION IS BELIEVED TO BE ACCURATE, IT IS PROVIDED "AS IS" AND MAY CONTAIN ERRORS OR MISPRINTS. THE OBJECT MANAGEMENT GROUP AND THE COMPANIES LISTED ABOVE MAKE NO WARRANTY OF ANY KIND, EXPRESS OR IMPLIED, WITH REGARD TO THIS PUBLICATION, INCLUDING BUT NOT LIMITED TO ANY WARRANTY OF TITLE OR OWNERSHIP, IMPLIED WARRANTY OF MERCHANTABILITY OR

WARRANTY OF FITNESS FOR A PARTICULAR PURPOSE OR USE.

IN NO EVENT SHALL THE OBJECT MANAGEMENT GROUP OR ANY OF THE COMPANIES LISTED ABOVE BE LIABLE FOR ERRORS CONTAINED HEREIN OR FOR DIRECT, INDIRECT, INCIDENTAL, SPECIAL, CONSEQUENTIAL, RELIANCE OR COVER DAMAGES, INCLUDING LOSS OF PROFITS, REVENUE, DATA OR USE, INCURRED BY ANY USER OR ANY THIRD PARTY IN CONNECTION WITH THE FURNISHING, PERFORMANCE, OR USE OF THIS MATERIAL, EVEN IF ADVISED OF THE POSSIBILITY OF SUCH DAMAGES.

The entire risk as to the quality and performance of software developed using this specification is borne by you. This disclaimer of warranty constitutes an essential part of the license granted to you to use this specification.

RESTRICTED RIGHTS LEGEND

Use, duplication or disclosure by the U.S. Government is subject to the restrictions set forth in subparagraph (c) (1) (ii) of The Rights in Technical Data and Computer Software Clause at DFARS 252.227-7013 or in subparagraph (c)(1) and (2) of the Commercial Computer Software - Restricted Rights clauses at 48 C.F.R. 52.227-19 or as specified in 48 C.F.R. 227-7202-2 of the DoD F.A.R. Supplement and its successors, or as specified in 48 C.F.R. 12.212 of the Federal Acquisition Regulations and its successors, as applicable. The specification copyright owners are as indicated above and may be contacted through the Object Management Group, 250 First Avenue, Needham, MA 02494, U.S.A.

TRADEMARKS

The OMG Object Management Group Logo®, CORBA®, CORBA Academy®, The Information Brokerage®, XMI® and IOP® are registered trademarks of the Object Management Group. OMG™, Object Management Group™, CORBA logos™, OMG Interface Definition Language (IDL)™, The Architecture of Choice for a Changing World™, CORBA services™, CORBA facilities™, CORBA med™, CORBA net™, Integrate 2002™, Middleware That's Everywhere™, UML™, Unified Modeling Language™, The UML Cube logo™, MOF™, CWM™, The CWM Logo™, Model Driven Architecture™, Model Driven Architecture Logos™, MDA™, OMG Model Driven Architecture™, OMG MDA™ and the XMI Logo™ are trademarks of the Object Management Group. All other products or company names mentioned are used for identification purposes only, and may be trademarks of their respective owners.

COMPLIANCE

The copyright holders listed above acknowledge that the Object Management Group (acting itself or through its designees) is and shall at all times be the sole entity that may authorize developers, suppliers and sellers of computer software to use certification marks, trademarks or other special designations to indicate compliance with these materials.

Software developed under the terms of this license may claim compliance or conformance with this specification if and only if the software compliance is of a nature fully matching the applicable compliance points as stated in the specification. Software developed only partially matching the applicable compliance points may claim only that the software was based on this specification, but may not claim compliance or conformance with this specification. In the event that testing suites are implemented or approved by Object Management Group, Inc., software developed using this specification may claim compliance or conformance with the specification only if the software satisfactorily completes the testing suites.

OMG's Issue Reporting Procedure

All OMG specifications are subject to continuous review and improvement. As part of this process we encourage readers to report any ambiguities, inconsistencies, or inaccuracies they may find by completing the Issue Reporting Form listed on the main web page <http://www.omg.org>, under Documents, Report a Bug/Issue (<http://www.omg.org/technology/agreement.htm>).

Table of Contents

| | |
|---|----|
| Preface | XV |
| 1 Scope | 1 |
| 2 Conformance | 1 |
| 3 Normative References | 2 |
| 3.1 Normative | 2 |
| 3.2 Non-Normative | 2 |
| 4 Terms and Definitions | 4 |
| 5 Symbols | 5 |
| 6 Additional Information | 5 |
| 6.1 Conventions | 5 |
| 6.1.1 Typographical and Linguistic Conventions and Style..... | 5 |
| 6.2 Dependency on Other Specifications..... | 6 |
| 6.3 Structure of this Document..... | 6 |
| 6.4 Acknowledgements..... | 6 |
| 7 Overview | 9 |
| 7.1 BPMN Scope | 10 |
| 7.1.1 Uses of BPMN..... | 10 |
| 7.1.2 Diagram Point of View | 13 |
| 7.1.3 Extensibility of BPMN and Vertical Domains | 14 |
| 8 Business Process Diagrams | 15 |
| 8.1 BPD Core Element Set | 15 |
| 8.2 BPD Complete Set | 18 |
| 8.3 Use of Text, Color, Size, and Lines in a Diagram | 26 |
| 8.4 Flow Object Connection Rules | 27 |
| 8.4.1 Sequence Flow Rules | 27 |
| 8.4.2 Message Flow Rules | 28 |
| 8.5 Business Process Diagram Attributes | 28 |
| 8.5.1 Changes Since 1.0 Draft Version..... | 29 |
| 8.6 Processes | 29 |
| 8.6.1 Attributes | 30 |
| 8.6.2 Changes Since 1.0 Draft Version..... | 31 |
| 9 Business Process Diagram Graphical Objects | 33 |
| 9.1 Common Graphical Object Attributes | 33 |
| 9.2 Common Flow Object Attributes | 33 |
| 9.2.1 Changes Since 1.0 Draft Version | 34 |

| | | |
|-----------|--|------------|
| 9.3 | Events | 34 |
| 9.3.1 | Common Event Attributes | 35 |
| 9.3.2 | Start | 35 |
| 9.3.3 | End | 40 |
| 9.3.4 | Intermediate | 43 |
| 9.4 | Activities | 49 |
| 9.4.1 | Common Activity Attributes | 49 |
| 9.4.2 | Sub-Process | 53 |
| 9.4.3 | Task | 62 |
| 9.5 | Gateways | 68 |
| 9.5.1 | Common Gateway Features | 70 |
| 9.5.2 | Exclusive Gateways (XOR) | 71 |
| 9.5.3 | Inclusive Gateways (OR) | 78 |
| 9.5.4 | Complex Gateways | 82 |
| 9.5.5 | Parallel Gateways (AND) | 85 |
| 9.6 | Swimlanes (Pools and Lanes) | 86 |
| 9.6.1 | Common Swimlane Attributes | 87 |
| 9.6.2 | Pool | 87 |
| 9.6.3 | Lane | 90 |
| 9.7 | Artifacts | 91 |
| 9.7.1 | Common Artifact Definitions..... | 92 |
| 9.7.2 | Data Object | 93 |
| 9.7.3 | Text Annotation | 95 |
| 9.7.4 | Group | 95 |
| 10 | Business Process Diagram Connecting Objects | 99 |
| 10.1 | Graphical Connecting Objects | 99 |
| 10.1.1 | Common Connecting Object Attributes..... | 99 |
| 10.1.2 | Sequence Flow | 100 |
| 10.1.3 | Message Flow | 102 |
| 10.1.4 | Association | 105 |
| 10.2 | Sequence Flow Mechanisms | 106 |
| 10.2.1 | Normal Flow | 107 |
| 10.2.2 | Exception Flow | 130 |
| 10.2.3 | Ad Hoc | 132 |
| 10.3 | Compensation Association | 133 |
| 11 | Mapping to BPEL4WS | 137 |
| 11.1 | Business Process Diagram Mappings | 137 |
| 11.2 | Business Process Mappings | 137 |
| 11.3 | Common Flow Object Mappings | 139 |
| 11.4 | Events | 139 |
| 11.4.1 | Start Event Mappings | 139 |
| 11.4.2 | End Event Mappings | 141 |
| 11.4.3 | Intermediate Event Mappings | 142 |
| 11.5 | Activities | 148 |
| 11.5.1 | Common Activity Mappings | 148 |
| 11.5.2 | Sub-Process Mappings | 166 |
| 11.5.3 | Task Mappings | 168 |

| | | |
|-----------|--|------------|
| 11.6 | Gateways | 171 |
| 11.6.1 | Common Gateway Mappings..... | 171 |
| 11.6.2 | Exclusive | 172 |
| 11.6.3 | Inclusive | 174 |
| 11.6.4 | Complex | 178 |
| 11.6.5 | Parallel | 178 |
| 11.7 | Pool | 178 |
| 11.8 | Lane | 178 |
| 11.9 | Artifacts | 178 |
| 11.10 | Sequence Flow | 179 |
| 11.10.1 | When to Map a Sequence Flow to a BPEL4WS Link | 181 |
| 11.11 | Message Flow | 182 |
| 11.12 | Association | 182 |
| 11.13 | Exception Flow..... | 182 |
| 11.14 | Compensation Association | 188 |
| 11.15 | Assignment Mapping | 189 |
| 11.16 | BPMN Supporting Type Elements | 189 |
| 11.17 | Determining the Extent of a BPEL4WS Structured Element | 190 |
| 11.17.1 | BPMN Elements that Span Multiple BPEL4WS Sub-Elements | 201 |
| 12 | BPMN by Example | 205 |
| 12.1 | The Beginning of the Process | 206 |
| 12.1.1 | Mapping to BPEL4WS | 206 |
| 12.2 | The First Sub-Process | 211 |
| 12.2.1 | Mapping to BPEL4WS | 213 |
| 12.3 | The Second Sub-Process | 217 |
| 12.3.1 | Mapping to BPEL4WS | 219 |
| 12.4 | The End of the Process | 224 |
| 12.4.1 | Mapping to BPEL4WS | 225 |
| | Annex A - E-Mail Voting Process BPEL4WS | 231 |
| | Annex B - BPMN Element Attributes and Types | 241 |
| | Annex C - Glossary | 273 |

List of Figures

| | |
|---|-----|
| Figure 7.1 - Example of Private Business Process | 11 |
| Figure 7.2 - Example of an Abstract Business Process | 11 |
| Figure 7.3 - Example of a Collaboration Business Process | 12 |
| Figure 9.1 - A Start Event | 35 |
| Figure 9.2 - End Event | 40 |
| Figure 9.3 - Intermediate Event | 44 |
| Figure 9.4 - Task with an Intermediate Event attached to its boundary | 44 |
| Figure 9.5 - Collapsed Sub-Process | 54 |
| Figure 9.6 - Expanded Sub-Process | 54 |
| Figure 9.7 - Expanded Sub-Process used as a “parallel box” | 55 |
| Figure 9.8 - Collapsed Sub-Process Markers | 55 |
| Figure 9.9 - A Sub-Process Object with its Details Shown in the Diagram of the Next Figure | 57 |
| Figure 9.10 - A Process and Diagram Details of the Sub-Process Object in the Previous Figure | 58 |
| Figure 9.11 - An Example of a Transaction Expanded Sub-Process | 60 |
| Figure 9.12 - A Task Object | 63 |
| Figure 9.13 - Task Markers | 63 |
| Figure 9.14 - A Gateway | 69 |
| Figure 9.15 - The Different types of Gateways | 69 |
| Figure 9.16 - An Exclusive Data-Based Decision (Gateway) Example without the Internal Indicator | 71 |
| Figure 9.17 - A Data-Based Exclusive Decision (Gateway) Example with the Internal Indicator | 72 |
| Figure 9.18 - An Exclusive Merge (Gateway) (without the Internal Indicator) | 72 |
| Figure 9.19 - Uncontrolled Merging of Sequence Flow | 73 |
| Figure 9.20 - Exclusive Gateway that merges Sequence Flow prior to an Parallel Gateway | 73 |
| Figure 9.21 - An Event-Based Decision (Gateway) Example Using Receive Tasks | 76 |
| Figure 9.22 - An Event-Based Decision (Gateway) Example Using Message Events | 76 |
| Figure 9.23 - An Inclusive Decision using Conditional Sequence Flow | 79 |
| Figure 9.24 - An Inclusive Decision using an OR Gateway | 80 |
| Figure 9.25 - An Inclusive Gateway Merging Sequence Flow | 80 |
| Figure 9.26 - A Complex Decision (Gateway) | 83 |
| Figure 9.27 - A Complex Merge (Gateway) | 83 |
| Figure 9.28 - A Parallel Gateway | 85 |
| Figure 9.29 - Joining – the joining of parallel paths | 85 |
| Figure 9.30 - A Pool | 87 |
| Figure 9.31 - Message Flow connecting to Flow Objects within two Pools | 89 |
| Figure 9.32 - Main (Internal) Pool without boundaries | 89 |
| Figure 9.33 - Two Lanes in a Pool | 91 |
| Figure 9.34 - A Data Object | 93 |
| Figure 9.35 - A Data Object associated with a Sequence Flow | 93 |
| Figure 9.36 - Data Objects shown as inputs and outputs | 94 |
| Figure 9.37 - A Text Annotation | 95 |
| Figure 9.38 - A Group Artifact | 96 |
| Figure 9.39 - A Group around activities in different Pools | 96 |
| Figure 10.1 - A Sequence Flow | 100 |
| Figure 10.2 - A Conditional Sequence Flow | 100 |
| Figure 10.3 - A Default Sequence Flow | 100 |

| | |
|--|-----|
| Figure 10.4 - A Message Flow | 102 |
| Figure 10.5 - Message Flow connecting to the boundaries of two Pools | 102 |
| Figure 10.6 - Message Flow connecting to Flow Objects within two Pools | 103 |
| Figure 10.7 - Message Flow connecting to boundary of Sub-Process and Internal objects | 104 |
| Figure 10.8 An Association | 105 |
| Figure 10.9 - A directional Association | 105 |
| Figure 10.10 An Association of Text Annotation | 105 |
| Figure 10.11 - An Association connecting a Data Object with a Flow | 106 |
| Figure 10.12 - Workflow Pattern #1: Sequence | 107 |
| Figure 10.13 - A Process with Normal Flow | 107 |
| Figure 10.14 - An Expanded Sub-Process without a Start Event and End Event | 108 |
| Figure 10.15 - An Expanded Sub-Process with a Start Event and End Event Internal | 109 |
| Figure 10.16 - An Expanded Sub-Process with a Start Event and End Event Attached to Boundary | 110 |
| Figure 10.17 - Workflow Pattern #2: Parallel Split -- Version 1 | 111 |
| Figure 10.18 - Workflow Pattern #2: Parallel Split -- Version 2 | 111 |
| Figure 10.19 - The Creation of Parallel Paths with a Gateway | 112 |
| Figure 10.20 - The Creation of Parallel Paths with Equivalent Conditions | 112 |
| Figure 10.21 - Workflow Pattern #2: Parallel Split -- Version 3 | 113 |
| Figure 10.22 - Workflow Pattern #3: Synchronization -- Version 1 | 113 |
| Figure 10.23 - Workflow Pattern #3: Synchronization -- Version 2 | 114 |
| Figure 10.24 - The Fork-Join Relationship is not Fixed | 114 |
| Figure 10.25 - A Data-Based Decision Example -- Workflow Pattern #4 -- Exclusive Choice | 115 |
| Figure 10.26 - Workflow Pattern #6 -- Multiple Choice -- Version 1 | 116 |
| Figure 10.27 - Workflow Pattern #6 -- Multiple Choice -- Version 2 | 116 |
| Figure 10.28 - A Complex Decision (Gateway) | 117 |
| Figure 10.29 - An Event-Based Decision Example | 117 |
| Figure 10.30 - Workflow Pattern #5 -- Simple Merge -- Version 1 | 118 |
| Figure 10.31 - Workflow Pattern #7 -- Multiple Merge | 118 |
| Figure 10.32 - Workflow Pattern #5 -- Simple Merge -- Version 2 | 119 |
| Figure 10.33 - Workflow Pattern #8 -- Discriminator | 119 |
| Figure 10.34 - Workflow Pattern #9 -- Synchronizing Join | 120 |
| Figure 10.35 - Workflow Pattern #8 -- N out of M Join | 120 |
| Figure 10.36 - The Split-Merge Relationship is not Fixed | 121 |
| Figure 10.37 - A Task and a Collapsed Sub-Process with a Loop Marker | 122 |
| Figure 10.38 - A Task with a Parallel Marker | 122 |
| Figure 10.39 - An Expanded Sub-Process with a Loop Marker | 123 |
| Figure 10.40 - Workflow Pattern #16 -- Arbitrary Cycle | 123 |
| Figure 10.41 - An Until Loop | 124 |
| Figure 10.42 - A While Loop | 124 |
| Figure 10.43 - Link Intermediate Event Used as Off-Page Connector | 125 |
| Figure 10.44 - Process with Long Sequence Flow | 126 |
| Figure 10.45 - Process with Link Intermediate Events Used as Go To Objects | 126 |
| Figure 10.46 - Link Intermediate Event Used for Looping | 126 |

| | |
|--|-----|
| Figure 10.47 - Example of Sub-Process with Start and End Events Inside | 127 |
| Figure 10.48 - Example of Sub-Process with Start and End Events on Boundary | 127 |
| Figure 10.49 - Link Events Used to Synchronize Behavior Across Processes | 128 |
| Figure 10.50 - Potentially a dead-locked model | 129 |
| Figure 10.51 - Improper Looping | 129 |
| Figure 10.52 - Improper use of a Link End Event | 130 |
| Figure 10.53 - A Task with Exception Flow (Interrupts Event Context) | 131 |
| Figure 10.54 - A Sub-Process with Exception Flow (Interrupts Event Context) | 131 |
| Figure 10.55 - A Collapsed Ad Hoc Sub-Process | 132 |
| Figure 10.56 - An Expanded Ad Hoc Sub-Process | 132 |
| Figure 10.57 - An Ad Hoc Process for Writing a Book Chapter | 133 |
| Figure 10.58 - A Task with an Associated Compensation Activity | 134 |
| Figure 10.59 - Compensation Shown in the context of a Transaction | 135 |
| Figure 11.1 - BPMN Depiction of BPEL4WS Pattern for a Standard loop, TestTime = Before | 151 |
| Figure 11.2 - BPMN Depiction of BPEL4WS Pattern for a Sequential Multi-Instance loop | 154 |
| Figure 11.3 - Structure of Process to be Spawned for Parallel Multi-instance | 157 |
| Figure 11.4 - BPEL4WS Pattern of Parallel Multi-instance, MI_FlowCondition = All | 159 |
| Figure 11.5 - BPEL4WS Pattern of Parallel Multi-instance, MI_FlowCondition = One | 162 |
| Figure 11.6 - BPEL4WS Pattern of Parallel Multi-instance, MI_FlowCondition = None | 165 |
| Figure 11.7 - BPEL4WS Pattern of Inclusive Decision with two (2) Gates and a DefaultGate | 176 |
| Figure 11.8 - Example: Sequence Flow that are not used for BPEL4WS links | 181 |
| Figure 11.9 - Example: A Sequence Flow that is used for a BPEL4WS link | 182 |
| Figure 11.10 - Exception Flow Merging back into Normal Flow Immediately after Interrupted Activity. | 183 |
| Figure 11.11 - Exception Flow Merging back into the Normal Flow Further Downstream | 184 |
| Figure 11.12 - Exception Flow Merging back into the Normal Flow at the End Event | 186 |
| Figure 11.13 - Example of Exception Flow Looping Back into the Normal Flow Upstream | 186 |
| Figure 11.14 - Example of Modification at BPEL4WS level to Handle the Loop | 187 |
| Figure 11.15 - Example of a Derived Process to Handle the Looping | 188 |
| Figure 11.16 - Identification of BPEL4WS structured element | 191 |
| Figure 11.17 - The Creation of Related Tokens | 192 |
| Figure 11.18 - Example of Recombination of Tokens | 193 |
| Figure 11.19 - Example of Partial Recombination of Tokens | 193 |
| Figure 11.20 - Example of Distributed Token Recombination. | 194 |
| Figure 11.21 - Example of nested BPEL4WS structural elements | 195 |
| Figure 11.22 - Example of a Loop from a Decision with Two Alternative Paths | 196 |
| Figure 11.23 - Example of a Loop from a Decision with more than Two Alternative Paths | 197 |
| Figure 11.24 - Example of Interleaved Loops | 198 |
| Figure 11.25 - Example of the BPEL4WS Pattern for Substituting for the Derived Process | 199 |
| Figure 11.26 - Example of a BPEL4WS Pattern for the Derived Process | 199 |
| Figure 11.27 - Example: An Infinite Loop | 200 |
| Figure 11.28 - Example: A Pair of Go To Link Events are Treated as a Single Sequence Flow | 201 |
| Figure 11.29 - Example: Activity that spans two paths of a BPEL4WS Structured Element | 202 |
| Figure 12.1 - E-Mail Voting Process | 205 |
| Figure 12.2 - The Start of the Process | 206 |
| Figure 12.3 - The Ongoing Starter Process | 207 |
| Figure 12.4 - “Discussion Cycle” Sub-Process Details | 212 |
| Figure 12.5 - “Collect Votes” Sub-Process Details | 218 |
| Figure 12.6 - The last segment of the E-Mail Voting Process | 224 |

List of Tables

| | |
|---|----|
| Table 8.1 - Core Modeling Elements | 16 |
| Table 8.2 - BPD Core Element Set..... | 17 |
| Table 8.3 - BPD Complete Element Set | 18 |
| Table 8.4 - Sequence Flow Connection Rules | 27 |
| Table 8.5 - Message Flow Connection Rules | 28 |
| Table 8.6 - Business Process Diagram Attributes..... | 28 |
| Table 8.7 - Process Attributes | 30 |
| Table 9.1 - Common Graphical Object Attributes | 33 |
| Table 9.2 - Common Flow Object Attributes..... | 33 |
| Table 9.3 - Common Event Attributes | 35 |
| Table 9.4 - Start Event Types | 37 |
| Table 9.5 - Start Event Attributes | 38 |
| Table 9.6 - End Event Types | 41 |
| Table 9.7 - End Event Attributes | 42 |
| Table 9.8 - Intermediate Event Types | 45 |
| Table 9.9 - Intermediate Event Attributes | 46 |
| Table 9.10 - Common Activity Attributes | 49 |
| Table 9.11 - Standard Loop Activity Attributes | 51 |
| Table 9.12 - Multi-Instance Loop Activity Attributes | 51 |
| Table 9.13 - Sub-Process Attributes | 56 |
| Table 9.14 - Embedded Sub-Process Attributes | 56 |
| Table 9.15 - Independent Sub-Process Attributes | 58 |
| Table 9.16 - Reference Sub-Process Attributes | 59 |
| Table 9.17 - Task Attributes | 64 |
| Table 9.18 - Service Task Attributes | 64 |
| Table 9.19 - Receive Task Attributes..... | 65 |
| Table 9.20 - Send Task Attributes | 65 |
| Table 9.21 - User Task Attributes | 66 |
| Table 9.22 - Script Task Attributes | 66 |
| Table 9.23 - Manual Task Attributes | 67 |
| Table 9.24 - Reference Task Attributes | 67 |
| Table 9.25 - Common Gateway Attributes | 70 |
| Table 9.26 - Data-Based Exclusive Gateway Attributes | 74 |
| Table 9.27 - Event-Based Exclusive Gateway Attributes..... | 77 |
| Table 9.28 - Inclusive Gateway Attributes | 81 |
| Table 9.29 - Complex Gateway Attributes..... | 84 |
| Table 9.30 - Parallel Gateway Attributes | 86 |
| Table 9.31 - Common Swimlane Attributes..... | 87 |
| Table 9.32 - Message Flow connecting to the boundaries of two Pools | 88 |
| Table 9.33 - Pool Attributes | 90 |
| Table 9.34 - Lane Attributes..... | 91 |

| | |
|---|-----|
| Table 9.35 - Common Artifact Attributes | 92 |
| Table 9.36 - Data Object Attributes | 94 |
| Table 9.37 - Text Annotation Attributes | 95 |
| Table 9.38 - Group Attributes | 97 |
| Table 10.1 - Common Connecting Object Attributes | 99 |
| Table 10.2 - Sequence Flow Attributes | 101 |
| Table 10.3 - Message Flow Attributes | 104 |
| Table 10.4 - Association Attributes | 106 |
| Table 11.1 - Business Process Diagram Mappings to BPEL4WS | 137 |
| Table 11.2 - Business Process Mappings to BPEL4WS | 137 |
| Table 11.3 - Common Flow Object Attribute Mappings to BPEL4WS | 139 |
| Table 11.4 - Start Event Mappings to BPEL4W | 139 |
| Table 11.5 - End Event Mappings to BPEL4WS | 141 |
| Table 11.6 - Intermediate Event Mappings to BPEL4WS | 142 |
| Table 11.7 - None Intermediate Mappings to BPEL4WS | 143 |
| Table 11.8 - Message Intermediate Mappings to BPEL4WS | 143 |
| Table 11.9 - Timer Intermediate Mappings to BPEL4WS | 144 |
| Table 11.10 - Error Intermediate Mappings to BPEL4WS | 145 |
| Table 11.11 - Cancel Intermediate Mappings to BPEL4WS | 145 |
| Table 11.12 - Rule Intermediate Mappings to BPEL4WS | 145 |
| Table 11.13 - Compensation Intermediate Mappings to BPEL4WS | 146 |
| Table 11.14 - Link Intermediate Mappings to BPEL4WS | 147 |
| Table 11.15 - Multiple Intermediate Mappings to BPEL4WS | 147 |
| Table 11.16 - Common Activity Mappings to BPEL4WS | 148 |
| Table 11.17 - Basic Activity Loop Mappings to BPEL4WS | 148 |
| Table 11.18 - Standard Activity Loop Mappings to BPEL4WS | 150 |
| Table 11.19 - Multi-Instance Activity Loop Setup Mappings to BPEL4WS | 152 |
| Table 11.20 - Sequential Multi-Instance Activity Loop Mappings to BPEL4WS | 153 |
| Table 11.21 - Parallel Multi-Instance Activity Loop Mappings to BPEL4WS | 156 |
| Table 11.22 - Parallel Multi-Instance Activity, MI_FlowCondition = All | 158 |
| Table 11.23 - Parallel Multi-Instance Activity Loop, MI_FlowCondition = One | 161 |
| Table 11.24 - Parallel Multi-Instance Activity Loop, MI_FlowCondition = Complex | 163 |
| Table 11.25 - Parallel Multi-Instance Activity Loop, MI_FlowCondition = None | 164 |
| Table 11.26 - Sub-Process Mappings to BPEL4WS | 166 |
| Table 11.27 - Embedded Sub-Process Mappings to BPEL4WS | 167 |
| Table 11.28 - Independent Sub-Process Mappings to BPEL4WS | 167 |
| Table 11.29 - Reference Sub-Process Mappings to BPEL4WS | 168 |
| Table 11.30 - Task Mappings to BPEL4WS | 168 |
| Table 11.31 - ServiceTask Mappings to BPEL4WS | 169 |
| Table 11.32 - Receive Task Mappings to BPEL4WS | 169 |
| Table 11.33 - Send Task Mappings to BPEL4WS | 169 |
| Table 11.34 - User Task Mappings to BPEL4WS | 170 |
| Table 11.35 - Script Task Mappings to BPEL4WS | 170 |

| | |
|---|-----|
| Table 11.36 - Reference Task Mappings to BPEL4WS | 171 |
| Table 11.37 - None Task Mappings to BPEL4WS | 171 |
| Table 11.38 - Common Gateway Mappings to BPEL4WS | 171 |
| Table 11.39 - Data-Based Exclusive Gateway Mappings to BPEL4WS | 172 |
| Table 11.40 - Data-Based Exclusive Gateway Mappings to BPEL4WS | 173 |
| Table 11.41 - Inclusive Gateway Mappings to BPEL4WS | 174 |
| Table 11.42 - Parallel Gateway Mappings to BPEL4WS | 178 |
| Table 11.43 - Exception Flow Mappings to BPEL4WS | 179 |
| Table 11.44 - Common Exception Flow Mappings to BPEL4WS | 183 |
| Table 11.45 - Exception Flow Merging back into the Normal Flow Further Downstream | 184 |
| Table 11.46 - Exception Flow Mappings to BPEL4WS | 188 |
| Table 11.47 - Assignment Mappings to BPEL4WS | 189 |
| Table 11.48 - Message Attributes | 189 |
| Table B.1 - Business Process Diagram Attributes | 241 |
| Table B.2 - Process Attributes | 242 |
| Table B.3 - Common Graphical Object Attributes | 243 |
| Table B.4 - Common Flow Object Attributes | 244 |
| Table B.5 - Common Event Attributes | 244 |
| Table B.6 - Start Event Attributes | 245 |
| Table B.7 - End Event Attributes | 246 |
| Table B.8 - Intermediate Event Attributes | 247 |
| Table B.9 - Common Activity Attributes | 249 |
| Table B.10 - Standard Loop Activity Attributes | 250 |
| Table B.11 - Multi-Instance Loop Activity Attributes | 251 |
| Table B.12 - Sub-Process Attributes | 252 |
| Table B.13 - Embedded Sub-Process Attributes | 252 |
| Table B.14 - Independent Sub-Process Attributes | 253 |
| Table B.15 - Reference Sub-Process Attributes | 253 |
| Table B.16 - Task Attributes | 254 |
| Table B.17 - Service Task Attributes | 254 |
| Table B.18 - Receive Task Attributes | 255 |
| Table B.19 - Send Task Attributes | 255 |
| Table B.20 - User Task Attributes | 256 |
| Table B.21 - Script Task Attributes | 256 |
| Table B.22 - Manual Task Attribute | 257 |
| Table B.23 - Reference Task Attributes | 257 |
| Table B.24 - Common Gateway Attributes | 257 |
| Table B.25 - Data-Based Exclusive Gateway Attributes | 258 |
| Table B.26 - Event-Based Exclusive Gateway Attributes | 259 |
| Table B.27 - Inclusive Gateway Attributes | 260 |
| Table B.28 - Complex Gateway Attributes | 261 |
| Table B.29 - Parallel Gateway Attributes | 262 |
| Table B.30 - Common Swimlane Attributes | 262 |

| | |
|--|-----|
| Table B.31 - Pool Attributes | 263 |
| Table B.32 - Lane Attributes | 263 |
| Table B.33 - Common Artifact Attributes | 264 |
| Table B.34 - Data Object Attributes | 264 |
| Table B.35 - Text Annotation Attributes | 265 |
| Table B.36 - Group Attributes | 265 |
| Table B.37 - Common Connecting Object Attributes | 265 |
| Table B.38 - Sequence Flow Attributes | 266 |
| Table B.39 - Message Flow Attributes | 267 |
| Table B.40 - Association Attributes | 267 |
| Table B.41 - Assignment Attributes | 268 |
| Table B.42 - Entity Attributes | 268 |
| Table B.43 - Expression Attributes | 269 |
| Table B.44 - Message Attributes | 269 |
| Table B.45 - Object Attributes | 269 |
| Table B.46 - Participant Attributes | 270 |
| Table B.47 - Property Attributes | 270 |
| Table B.48 - Role Attributes | 270 |
| Table B.49 - Rule Attributes | 271 |
| Table B.50 - Transaction Attributes | 271 |
| Table B.51 - Web Service Attributes | 271 |

List of Examples

| | |
|--|-----|
| Example 11.1 - BPEL4WS Sample for a Standard Loop | 152 |
| Example 11.2 - BPEL4WS Sample for a Multi-Instance Loop with Sequential Ordering | 155 |
| Example 11.3 - BPEL4WS Sample of a derived process for Parallel Multi-Instance loops | 158 |
| Example 11.4 - BPEL4WS Sample of a Parallel Multi-Instance Loop, MI_FlowCondition = All ... | 160 |
| Example 11.5 - BPEL4WS Sample of a Parallel Multi-Instance Loop, MI_FlowCondition = One ... | 163 |
| Example 11.6 - BPEL4WS Sample of a Parallel Multi-Instance Loop, MI_FlowCondition = None .. | 166 |
| Example 11.7 - BPEL4WS Sample for the Pattern for an Inclusive Decision with a DefaultGate ... | 178 |
| Example 11.8 - Example: BPMN Elements that Span Multiple BPEL4WS Sub-Elements | 203 |
| Example 12.1 - BPEL4WS Sample for Beginning of E-Mail Voting Process | 212 |
| Example 12.2 - BPEL4WS Sample of “Discussion Cycle” Sub-Process Details | 218 |
| Example 12.3 - BPEL4WS Sample that sets up the Access for the Second Sub-Process | 221 |
| Example 12.4 - BPEL4WS Sample of the Second Sub-Process | 224 |
| Example 12.5 - Sample BPEL4WS code for the last section of the Process | 229 |
| Example 12.6 - Sample BPEL4WS code for derived process for repeated elements | 231 |

Preface

About the Object Management Group

OMG

Founded in 1989, the Object Management Group, Inc. (OMG) is an open membership, not-for-profit computer industry standards consortium that produces and maintains computer industry specifications for interoperable, portable and reusable enterprise applications in distributed, heterogeneous environments. Membership includes Information Technology vendors, end users, government agencies and academia.

OMG member companies write, adopt, and maintain its specifications following a mature, open process. OMG's specifications implement the Model Driven Architecture® (MDA®), maximizing ROI through a full-lifecycle approach to enterprise integration that covers multiple operating systems, programming languages, middleware and networking infrastructures, and software development environments. OMG's specifications include: UML® (Unified Modeling Language™); CORBA® (Common Object Request Broker Architecture); CWM™ (Common Warehouse Metamodel); and industry-specific standards for dozens of vertical markets.

More information on the OMG is available at <http://www.omg.org/>.

OMG Specifications

As noted, OMG specifications address middleware, modeling and vertical domain frameworks. A catalog of all OMG Specifications Catalog is available from the OMG website at:

http://www.omg.org/technology/documents/spec_catalog.htm

Specifications within the Catalog are organized by the following categories:

OMG Modeling Specifications

- UML
- MOF
- XMI
- CWM
- Profile specifications.

OMG Middleware Specifications

- CORBA/IIOP
- IDL/Language Mappings
- Specialized CORBA specifications
- CORBA Component Model (CCM).

Platform Specific Model and Interface Specifications

- CORBA services

- CORBA facilities
- OMG Domain specifications
- OMG Embedded Intelligence specifications
- OMG Security specifications.

All of OMG's formal specifications may be downloaded without charge from our website. (Products implementing OMG specifications are available from individual suppliers.) Copies of specifications, available in PostScript and PDF format, may be obtained from the Specifications Catalog cited above or by contacting the Object Management Group, Inc. (as of January 16, 2006) at:

OMG Headquarters
140 Kendrick Street
Building A, Suite 300
Needham, MA 02494
USA
Tel: +1-781-444-0404
Fax: +1-781-444-0320
Email: pubs@omg.org

Certain OMG specifications are also available as ISO standards. Please consult <http://www.iso.org>

Typographical Conventions

The type styles shown below are used in this document to distinguish programming statements from ordinary English. However, these conventions are not used in tables or section headings where no distinction is necessary.

Times/Times New Roman - 10 pt.: Standard body text

Helvetica/Arial - 10 pt. Bold: OMG Interface Definition Language (OMG IDL) and syntax elements.

Courier - 10 pt. Bold: Programming language elements.

Helvetica/Arial - 10 pt: Exceptions

Note – Terms that appear in *italics* are defined in the glossary. Italic text also represents the name of a document, specification, or other publication.

Issues

The reader is encouraged to report any technical or editing issues/problems with this specification to <http://www.omg.org/technology/agreement.htm>.

1 Scope

The **Business Process Management Initiative** (BPMI) has developed a standard **Business Process Modeling Notation** (BPMN). The primary goal of BPMN is to provide a notation that is readily understandable by all business users, from the business analysts that create the initial drafts of the processes, to the technical developers responsible for implementing the technology that will perform those processes, and finally, to the business people who will manage and monitor those processes. Thus, BPMN creates a standardized bridge for the gap between the business process design and process implementation.

Another goal, but no less important, is to ensure that XML languages designed for the execution of business processes, such as **BPEL4WS** (Business Process Execution Language for Web Services), can be visualized with a business-oriented notation.

This specification defines the notation and semantics of a **Business Process Diagram** (BPD) and represents the amalgamation of best practices within the business modeling community. The intent of BPMN is to standardize a business process modeling notation in the face of many different modeling notations and viewpoints. In doing so, BPMN will provide a simple means of communicating process information to other business users, process implementers, customers, and suppliers.

The membership of the BPMI Notation Working Group has brought forth expertise and experience with many existing notations and has sought to consolidate the best ideas from these divergent notations into a single standard notation. Examples of other notations or methodologies that were reviewed are UML Activity Diagram, UML EDOC Business Processes, IDEF, ebXML BPSS, Activity-Decision Flow (ADF) Diagram, RosettaNet, LOVeM, and Event-Process Chains (EPCs).

2 Conformance

A **BPMN implementation** is responsible to perform one or more duties, as outlined below, based on the information contained in this specification.

There are three main aspects of conformance to the BPMN Specification:

1. *The visual appearance of the BPMN graphical elements.* A key element of BPMN is the choice of shapes and icons used for the graphical elements identified in this specification. The intent is to create a standard visual language that all process modelers will recognize and understand, regardless of the source of the Diagram. Any tool that is used to create BPMN Diagrams **MUST** conform to the shapes and markers as defined in this specification. Note that there is flexibility in the size, color, line style, and text positions of the defined graphical elements. Extensions to a BPD are allowed as follows:
 - Extensions can be made to the Diagram elements by way of new markers or indicators associated with the current graphical elements. These markers or indicators could be used to highlight a specific attribute of an activity or to create a new type of Event, for example. In addition, Extensions could also include coloring an object or changing a line style of an object, with the condition that change **MUST NOT** conflict with any current BPMN defined line style.
 - Extensions **MUST NOT** change the basic shape of the defined graphical elements and markers (e.g., changing a square into a triangle, or changing rounded corners into squared corners, etc.).
 - Any number of Artifacts, consisting of a variety of shapes, can be added to a Diagram, with the condition that the Artifact shape **MUST NOT** conflict with any current object shape or defined marker.

2. *The semantics of the BPMN elements.* This specification also defines how the graphical elements will interact with each other, including conditional interactions based on attributes that create behavioral variations of the elements. A conformant tool **MUST** adhere to these semantic definitions.
 - Throughout the document, specific BPMN semantic definitions will be identified through a special shaped bulleted paragraph, as shown in the following example:
 - ◆ A Task **MAY** be a target for Sequence Flow; it can have multiple incoming Flow. Incoming Flow **MAY** be from an alternative path and/or a parallel paths.
3. *The exchange of BPMN Diagrams between conformant tools.* This draft of the specification will not contain a standard mechanism for Diagram exchange. The nature of this mechanism has not been defined yet. It could involve the development of a BPMN XML schema that is layered upon the BPEL4WS XML schema or it could involve the use of standard Diagram interchange formats, such a XML. When an exchange mechanism has been defined, a conformant tool **MUST** be able to import and export BPMN Diagrams in the specified format.

A conformant implementation is not required to process any non-normative extension elements or attributes, or any BPMN document that contains them.

3 Normative References

3.1 Normative

RFC-2119

- Key words for use in RFCs to Indicate Requirement Levels, S. Bradner, IETF RFC 2119, March 1997
<http://www.ietf.org/rfc/rfc2119.txt>

BPEL4WS

- (BPEL4WS) 1.1, IBM/Microsoft/BEA/SAP/Siebel, July 2002
<http://www-106.ibm.com/developerworks/webservices/library/ws-bpel/>

3.2 Non-Normative

Activity Service

- Additional Structuring Mechanism for the OTS specification, OMG, June 1999
<http://www.omg.org>
- J2EE Activity Service for Extended Transactions (JSR 95), JCP
<http://www.jcp.org/jsr/detail/95.jsp>

Business Process Definition

- Response to OMG BPD RFP, OMG, Sept. 2003, bei/03-08-02
<http://www.omg.org>

Business Process Modeling

- Jean-Jacques Dubray, “A Novel Approach for Modeling Business Process Definitions,” 2002

<http://www.ebpml.org/ebpml2.2.doc>

Business Transaction Protocol

- OASIS BTP Technical Committee, June, 2002
http://www.oasis-open.org/committees/download.php/1184/2002-06-03.BTP_cttee_spec_1.0.pdf

BPML

- (BPML) 1.0, BPML, January 2003
<http://www.BPML.org>

Dublin Core Meta Data

- Dublin Core Metadata Element Set, Dublin Core Metadata Initiative
<http://dublincore.org/documents/dces/>

ebXML BPSS

- Jean-Jacques Dubray, “A new model for ebXML BPSS Multi-party Collaborations and Web Services Choreography,” 2002
<http://www.ebpml.org/ebpml.doc>

OMG UML

- Unified Modeling Language Specification, OMG, August 2005
<http://www.omg.org>

Open Nested Transactions

- Concepts and Applications of Multilevel Transactions and Open Nested Transactions, Gerhard Weikum, Hans-J. Schek, 1992
<http://citeseer.nj.nec.com/weikum92concepts.html>

RDF

- RDF Vocabulary Description Language 1.0: RDF Schema, W3C Working Draft
<http://www.w3.org/TR/rdf-schema/>

SOAP 1.2

- SOAP Version 1.2 Part 1: Messaging Framework, W3C Working Draft
<http://www.w3.org/TR/soap12-part1/>
- SOAP Version 1.2 Part21: Adjuncts, W3C Working Draft
<http://www.w3.org/TR/soap12-part2/>

UDDI

- Universal Description, Discovery and Integration, Ariba, IBM and Microsoft, UDDI.org.
<http://www.uddi.org>

URI

- Uniform Resource Identifiers (URI): Generic Syntax, T. Berners-Lee, R. Fielding, L. Masinter, IETF RFC 2396,

August 1998

<http://www.ietf.org/rfc/rfc2396.txt>

WfMC Glossary

- Workflow Management Coalition Terminology and Glossary.
<http://www.wfmc.org/standards/docs.htm>

Web Services Transaction

- (WS-Transaction) 1.0, IBM/Microsoft/BEA, August, 2002
<http://www-106.ibm.com/developerworks/webservices/library/ws-transpec/>

WSDL

- Web Services Description Language (WSDL) 1.1, W3C Note, 15 March 2001
<http://www.w3.org/TR/wsdl.html>

XML 1.0 (Second Edition)

- Extensible Markup Language (XML) 1.0, Second Edition, Tim Bray et al., eds., W3C, 6 October 2000
<http://www.w3.org/TR/REC-xml>

XML-Namespaces

- Namespaces in XML, Tim Bray et al., eds., W3C, 14 January 1999
<http://www.w3.org/TR/REC-xml-names>

XML-Schema

- XML Schema Part 1: Structures, Henry S. Thompson, David Beech, Murray Maloney, Noah Mendelsohn, W3C, 2 May 2001
<http://www.w3.org/TR/xmlschema-1/>
- XML Schema Part 2: Datatypes, Paul V. Biron and Ashok Malhotra, eds., W3C, 2 May 2001
<http://www.w3.org/TR/xmlschema-2/>

XPath

- XML Path Language (XPath) 1.0, James Clark and Steve DeRose, eds., W3C, 16 November 1999
<http://www.w3.org/TR/xpath>

XPDL

- Workflow Management Coalition XML Process Definition Language.
<http://www.wfmc.org/standards/docs.htm>

4 Terms and Definitions

See Annex C - Glossary.

5 Symbols

There are no symbols defined in this specification.

6 Additional Information

6.1 Conventions

The section introduces the conventions used in this document. This includes (text) notational conventions and notations for schema components. Also included are designated namespace definitions.

6.1.1 Typographical and Linguistic Conventions and Style

This specification incorporates the following conventions:

- The keywords “MUST,” “MUST NOT,” “REQUIRED,” “SHALL,” “MUST NOT,” “SHOULD,” “SHOULD NOT,” “RECOMMENDED,” “MAY,” and “OPTIONAL” in this document are to be interpreted as described in RFC-2119.
- A **term** is a word or phrase that has a special meaning. When a term is defined, the term name is highlighted in **bold** typeface.
- A reference to another definition, section, or specification is highlighted with underlined typeface and provides a link to the relevant location in this specification.
- A reference to an element, attribute, or **BPMN** construct is highlighted with a capitalized word (e.g., Sub-Process).
- A reference to a **BPEL4WS** element, attribute, or construct is highlighted with an italic lower-case word, usually preceded by the word “BPEL4WS” (e.g., *BPEL4WS pick*).
- Non-normative examples are set off in boxes and accompanied by a brief explanation.
- XML and pseudo code is highlighted with `mono-spaced` typeface. Different font colors may be used to highlight the different components of the XML code.
- The cardinality of any content part is specified using the following operators:
 - `<none>` — exactly once
 - `(0-1)` — 0 or 1
 - `(0-n)` — 0 or more
 - `(1-n)` — 1 or more
- Attributes separated by `|` and grouped within `(and)` — alternative values
 - `<value>` — default value
 - `<type>` — the type of the attribute

6.2 Dependency on Other Specifications

The BPMN specification supports for the following specifications is a normative part of the BPMN specification: BPEL4WS.

The following abbreviations may be used throughout this document:

| This abbreviation | Refers to |
|-------------------|---|
| BPEL4WS | Business Process Execution Language for Web Services (see BPEL4WS). This abbreviation refers specifically to version 1.1 of the specification. |
| WSDL | Web Service Description Language (see WSDL). This abbreviation refers specifically to the W3C Technical Note, 15 March 2001, but is intended to support future versions of the WSDL specification |

6.3 Structure of this Document

The BPMN specification defines the Business Process Diagram modeling objects, their semantics, their mapping to BPEL4WS, and is comprised of the following topics:

BPMN Overview provides an introduction to BPMN, its requirements, and discusses the range of modeling purposes that BPMN can convey.

Business Process Diagrams provides a summary of the BPMN graphical elements and their relationships.

Business Process Diagram Graphical Objects details the graphical representation, attributes, and semantics of the behavior of BPMN Diagram elements.

Business Process Diagram Connecting Objects defines the graphical objects used to connect two objects together (i.e., the connecting lines of the Diagram) and how flow progresses through a Process (i.e., through a straight sequence or through the creation of parallel or alternative paths).

Mapping to BPEL4WS provides the formal mechanism for converting a Business Process to a BPEL4WS document.

BPMN by Example provides a walkthrough of a sample Process using BPMN and its particular mapping to BPEL4WS.

Annex A: E-Mail Voting Process BPEL4WS provides a full sample of BPEL4WS code based on the example business process described in the “BPMN by Example” section.

Annex B: BPMN Element Attributes and Types provides the complete set of BPMN Element attributes, which are first presented in Chapters 8, 9, and 10, and the definition of types that support the attributes.

Annex C: Glossary presents an alphabetical index of terms that are relevant to practitioners of BPMN.

6.4 Acknowledgements

The author/editor of the specification:

- Stephen A. White, IBM Corporation (wstephe@us.ibm.com)

The members of the BPMI Notation Working Group contributed to the development of this specification, including those who contributed to the text and editing of the specification:

- Ashish Agrawal, Intalio (ashish@intalio.com)
- Michael Anthony, International Performance Group (manthony@ipgl.com)
- Assaf Arkin, Intalio (arkin@intalio.com)
- Steve Ball, Sterling Commerce (steve_ball@stercomm.com)
- Rob Bartel, iGrafx (rob.bartel@igrafx.com)
- Steinar Carlsen, Computas (sca@computas.com)
- Ugo Corda, SeeBeyond Technology Corporation (ucorda@seebeyond.com)
- Tony Fletcher (tony_fletcher@btopenworld.com)
- Steven Forgey, SeeBeyond Technology Corporation (sforgey@seebeyond.com)
- Jean-Luc Giraud, Axway Software (jlgiraud@axway.com)
- Paul Harmon (pharmon@sbcglobal.net)
- Damion Heredia, Lombardi Software (damion.herediat@lombardisoftware.com)
- George Keeling, Casewise (george@casewise.co.uk)
- Brian James, Proforma (bjames@proformacorp.com)
- Antoine Lonjon, Mega International (alonjon@mega.com)
- Mike Marin, FileNet (mmarin@filenet.com)
- Lee Mason, webMethods (mason.lee@webmethods.com)
- Derek Miers, Enix Consulting Ltd. (miers@enix.co.uk)
- Alex Moffat, Lombardi Software (alex.moffat@lombardisoftware.com)
- Roberta Norin, Pegasystems (roberta.norin@pega.com)
- Martin Owen, Popkin Software (martin.owen@popkin.co.uk)
- Jog Raj, Popkin Software (jog.raj@popkin.co.uk)
- Bob Smith, Tall Tree Labs (robsmith5@1talltrees.com)
- Manfred Sturm, ITPearls AG (manfred.sturm@itpearls.com)
- Balasubramanian (Bala) Suryanarayanan, Infosys (balas@infosys.com)
- Roy Thompson, Casewise (roy.thompson@casewise.co.uk)
- Paul Vincent, Fair, Isaac & Company (paulvincent@fairisaac.com)
- Paul Wuethrich, Sybase (pwuethri@sybase.com)
- Petko Chobantonov, Lombardi Software

The members of the BPMI Notation Working Group would like to thank SeeBeyond Technology Corporation and International Business Machines Corporation for their valuable support in the development of this specification.

7 Overview

There has been much activity in the past two or three years in developing web service-based XML execution languages for Business Process Management (BPM) systems. Languages such as BPEL4WS provide a formal mechanism for the definition of business processes. The key element of such languages is that they are optimized for the operation and inter-operation of BPM Systems. The optimization of these languages for software operations renders them less suited for direct use by humans to design, manage, and monitor business processes. BPEL4WS has both graph and block structures and utilizes the principles of formal mathematical models, such as pi-calculus¹. This technical underpinning provides the foundation for business process execution to handle the complex nature of both internal and B2B interactions and take advantage of the benefits of Web services. Given the nature of BPEL4WS, a complex business process could be organized in a potentially complex, disjointed, and unintuitive format that is handled very well by a software system (or a computer programmer), but would be hard to understand by the business analysts and managers tasked to develop, manage, and monitor the process. Thus, there is a human level of “inter-operability” or “portability” that is not addressed by these web service-based XML execution languages.

Business people are very comfortable with visualizing business processes in a flow-chart format. There are thousands of business analysts studying the way companies work and defining business processes with simple flow charts. This creates a technical gap between the format of the initial design of business processes and the format of the languages, such as BPEL4WS, that will execute these business processes. This gap needs to be bridged with a formal mechanism that maps the appropriate visualization of the business processes (a notation) to the appropriate execution format (a BPM execution language) for these business processes.

Inter-operation of business processes at the human level, rather than the software engine level, can be solved with standardization of the Business Process Modeling Notation (BPMN). BPMN provides a Business Process Diagram (BPD), which is a Diagram designed for use by the people who design and manage business processes. BPMN also provides a formal mapping to an execution language of BPM Systems (BPEL4WS). Thus, BPMN would provide a standard visualization mechanism for business processes defined in an execution optimized business process language.

BPMN will provide businesses with the capability of understanding their internal business procedures in a graphical notation and will give organizations the ability to communicate these procedures in a standard manner. Currently, there are scores of process modeling tools and methodologies. Given that individuals will move from one company to another and that companies will merge and diverge, it is likely that business analysts are required to understand multiple representations of business processes--potentially different representations of the same process as it moves through its lifecycle of development, implementation, execution, monitoring, and analysis. Therefore, a standard graphical notation will facilitate the understanding of the performance collaborations and business transactions within and between the organizations. This will ensure that businesses will understand themselves and participants in their business and will enable organizations to adjust to new internal and B2B business circumstances quickly. To do this, BPMN will follow the tradition of flowcharting notations for readability; yet still provide a mapping to the executable constructs. BPMN is using the experience of the business process notations that have preceded BPMN to create the next generation notation that combines readability, flexibility, and expandability.

BPMN will also advance the capabilities of traditional business process notations by inherently handling B2B business process concepts, such as public and private processes and choreographies, as well as advanced modeling concepts, such as exception handling, transactions, and compensation.

1. See Milner, 1999, “Communicating and Mobile Systems: the Π -Calculus,” Cambridge University Press. ISBN 0 521 64320 1 (hc.) ISBN 0 521 65869 1 (pbk.)

7.1 BPMN Scope

BPMN will be constrained to support only the concepts of modeling that are applicable to business processes. This means that other types of modeling done by organizations for business purposes will be out of scope for BPMN. For example, the modeling of the following will not be a part of BPMN:

- Organizational structures and Resources
- Functional breakdowns
- Data and information models
- Strategy
- Business Rules

Since these types of high-level modeling either directly or indirectly affects business processes, the relationships between BPMN and other high-level business modeling will be defined more formally as BPMN and other specifications are advanced.

In addition, while BPMN will show the flow of data (messages), and the association of data Artifacts to activities, it is not a data flow Diagram.

7.1.1 Uses of BPMN

Business process modeling is used to communicate a wide variety of information to a wide variety of audiences. BPMN is designed to cover many types of modeling and allows the creation of end-to-end business processes. The structural elements of BPMN will allow the viewer to be able to easily differentiate between sections of a BPMN Diagram.

There are three basic types of sub-models within an end-to-end BPMN model:

- Private (internal) business processes
- Abstract (public) processes
- Collaboration (global) Processes

Note – The terminology used to describe the different types of processes has not been standardized. Definitions of these terms are in flux. There is work being done in the World Wide Web Consortium (W3C) and in the Organization for the Advancement of Structured Information Standards (OASIS) that will hopefully consolidate these terms.

Some BPMN specification terms regarding the use of Swimlanes (e.g., Pools and Lanes) are used in the descriptions below. “Swimlanes (Pools and Lanes)” on page 262 for more details on how these elements are used in a BPD.

Private (Internal) Business Processes

Private business processes are those internal to a specific organization and are the types of processes that have been generally called workflow or BPM processes (see Figure 7.1). A single private business process may be mapped to one or more BPEL4WS documents.

If Swimlanes are used then a private business process will be contained within a single Pool. The Sequence Flow of the Process is therefore contained within the Pool and cannot cross the boundaries of the Pool. Message Flow can cross the Pool boundary to show the interactions that exist between separate private business processes. Thus, a single Business Process Diagram may show multiple private business processes, each with separate mappings to BPEL4WS.

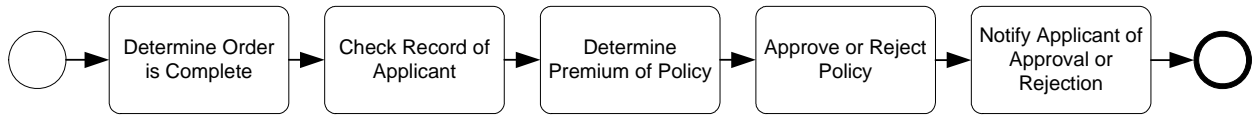

Figure 7.1 - Example of Private Business Process

Abstract (Public) Processes

This represents the interactions between a private business process and another process or participant (see Figure 7.2). Only those activities that are used to communicate outside the private business process, plus the appropriate flow control mechanisms, are included in the abstract process. All other “internal” activities of the private business process are not shown in the abstract process. Thus, the abstract process shows to the outside world the sequence of messages that are required to interact with that business process. A single abstract process may be mapped to a single BPEL4WS abstract process (however, this mapping will not be done in this version of the specification).

Abstract processes are contained within a Pool and can be modeled separately or within a larger BPMN Diagram to show the Message Flow between the abstract process activities and other entities. If the abstract process is in the same Diagram as its corresponding private business process, then the activities that are common to both processes can be associated.

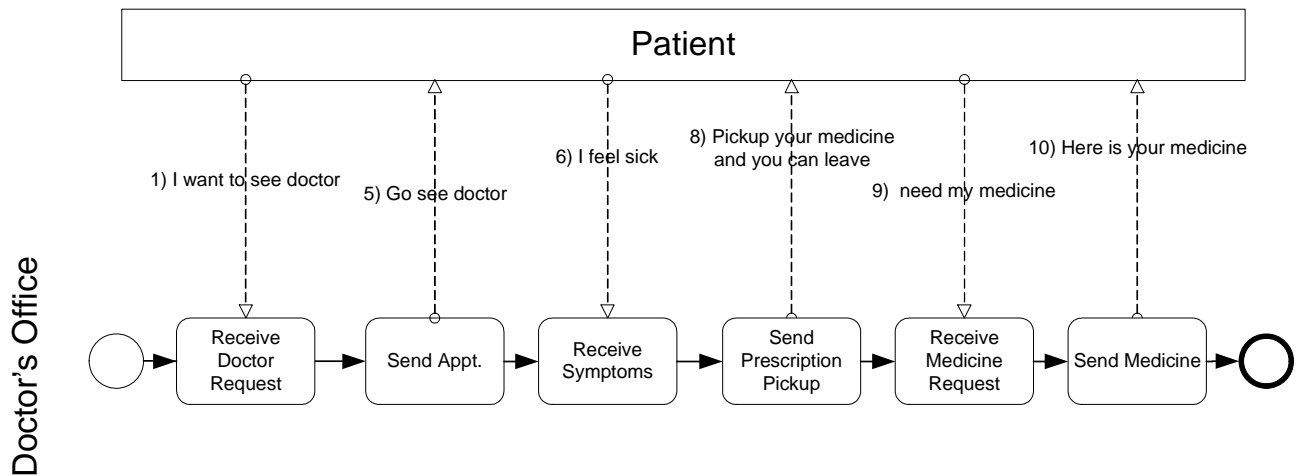

Figure 7.2 - Example of an Abstract Business Process

Collaboration (Global) Processes

A collaboration process depicts the interactions between two or more business entities. These interactions are defined as a sequence of activities that represent the message exchange patterns between the entities involved. A single collaboration process may be mapped to various collaboration languages, such as ebXML BPSS, RosettaNet, or the resultant specification from the W3C Choreography Working Group (however, these mappings are considered as future directions for BPMN).

The collaboration process can be shown as two or more abstract processes communicating with each other (see Figure 7.3). With an abstract process, the activities for the collaboration participants can be considered the “touch-points” between the participants. The actual (executable) processes are likely to have much more activity and detail than what is shown in the abstract processes.

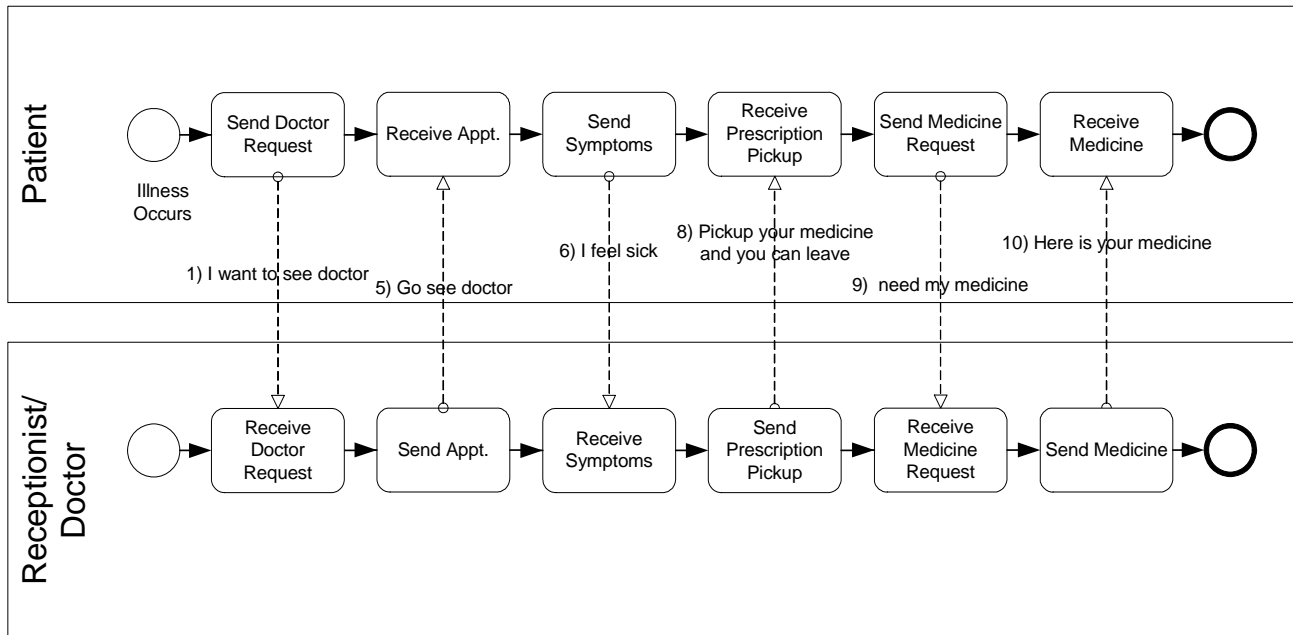

Figure 7.3 - Example of a Collaboration Business Process

Types of BPD Diagrams

Within and between these three BPMN sub-models, many types of Diagrams can be created. The following are the types of business processes that can be modeled with BPMN (those with asterisks may not map to an executable language):

- High-level private process activities (not functional breakdown)*
- Detailed private business process
 - As-is or old business process*
 - To-be or new business process
- Detailed private business process with interactions to one or more external entities (or “Black Box” processes)
- Two or more detailed private business processes interacting
- Detailed private business process relationship to Abstract Process
- Detailed private business process relationship to Collaboration Process
- Two or more Abstract Processes*
- Abstract Process relationship to Collaboration Process*
- Collaboration Process only (e.g., ebXML BPSS or RosettaNet)*
- Two or more detailed private business processes interacting through their Abstract Processes

- Two or more detailed private business processes interacting through a Collaboration Process
- Two or more detailed private business processes interacting through their Abstract Processes and a Collaboration Process

BPMN is designed to allow all the above types of Diagrams. However, it should be cautioned that if too many types of sub-models are combined, such as three or more private processes with message flow between each of them, then the Diagram may become too hard for someone to understand. Thus, we recommend that the modeler pick a focused purpose for the BPD, such as a private process, or a collaboration process.

BPMN mappings

Since BPMN covers such a wide range of usage, it will map to more than one lower-level specification language:

- BPEL4WS are the primary languages that BPMN will map to, but they only cover a single executable private business process. If a BPMN Diagram depicts more than one internal business process, then there will be a separate mapping for each of the internal business processes.
- The abstract sections of a BPMN Diagram will be mapped to Web service interfaces specifications, such as the abstract processes of BPEL4WS.
- The Collaboration model sections of a BPMN may be mapped to Collaboration models such as ebXML BPSS, Rosetta-Net, and the W3C Choreography Working Group Specification (when it is completed).

This specification will only cover a mapping to BPEL4WS. Mappings to other specifications will have to be a separate effort, or perhaps a future direction of BPMN (beyond Version 1.0 of the BPMN specification). It is hard to predict which mappings will be applied to BPMN at this point, since process language specifications is a volatile area of work, with many new offerings and mergings.

A BPD is not designed to graphically convey all the information required to execute a business process. Thus, the graphic elements of BPMN will be supported by attributes that will supply the additional information required to enable a mapping to BPEL4WS. A complete list of all the element attributes can be found in Appendix B.

7.1.2 Diagram Point of View

Since a BPMN Diagram may depict the Processes of different Participants, each Participant may view the Diagram differently. That is, the Participants have different points of view regarding how the Processes will behave. Some of the activities will be internal to the Participant (meaning performed by or under control of the Participant) and other activities will be external to the Participant. Each Participant will have a different perspective as to which are internal and external. At runtime, the difference between internal and external activities is important in how a Participant can view the status of the activities or trouble-shoot any problems. However, the Diagram itself remains the same. Figure 7.3, above, displays a Business Process that has two points of view. One point of view is of a Patient, the other is of the Doctor's office. The Diagram shows the activities of both participants in the Process, but when the Process is actually being performed, each Participant will really have control over their own activities.

Although the Diagram point of view is important for a viewer of the Diagram to understand how the behavior of the Process will relate to that viewer, BPMN will not currently specify any graphical mechanisms to highlight the point of view. It is open to the modeler or modeling tool vendor to provide any visual cues to emphasize this characteristic of a Diagram.

7.1.3 Extensibility of BPMN and Vertical Domains

BPMN is intended to be extensible by modelers and modeling tools. This extensibility allows modelers to add non-standard elements or Artifacts to satisfy a specific need, such as the unique requirements of a vertical domain. While extensible, BPMN Diagrams should still have the basic look-and-feel so that a Diagram by any modeler should be easily understood by any viewer of the Diagram. Thus the footprint of the basic flow elements (Events, activities, and Gateways) should not be altered. Nor should any new flow elements be added to a BPD, since there is no specification as to how Sequence and Message Flow will connect to any new Flow Object. In addition, mappings to execution languages may be affected if new flow elements are added. To satisfy additional modeling concepts that are not part of the basic set of flow elements, BPMN provides the concept of Artifacts that can be linked to the existing Flow Objects through Associations. Thus, Artifacts do not affect the basic Sequence or Message Flow, nor do they affect mappings to execution languages.

The graphical elements of BPMN are designed to be open to allow specialized markers to convey specialized information. For example, the three types of Events all have open centers for the markers that BPMN standardizes as well as user-defined markers.

8 Business Process Diagrams

This chapter provides a summary of the BPMN graphical objects and their relationships. More details on the concepts will be provided in “Business Process Diagram Graphical Objects” on page 33 and “Business Process Diagram Connecting Objects” on page 99.

A goal for the development of BPMN is that the notation be simple and adoptable by business analysts. Also, there is a potentially conflicting requirement that BPMN provide the power to depict complex business processes and map to BPM execution languages. To help understand how BPMN can manage both requirements, the list of BPMN graphic elements is presented in two groups.

First, there is the list of core elements that will support the requirement of a simple notation. These are the elements that define the basic look-and-feel of BPMN. Most business processes will be modeled adequately with these elements. Second, there is the entire list of elements, including the core elements, which will help support requirement of a powerful notation to handle more advanced modeling situations. And further, the graphical elements of the notation will be supported by non-graphical attributes that will provide the remaining information necessary to map to an execution language or other business modeling purposes.

8.1 BPD Core Element Set

It should be emphasized that one of the drivers for the development of BPMN is to create a simple mechanism for creating business process models, while at the same time being able to handle the complexity inherent to business processes. The approach taken to handle these two conflicting requirements was to organize the graphical aspects of the notation into specific categories. This provides a small set of notation categories so that the reader of a BPMN diagram can easily recognize the basic types of elements and understand the diagram. Within the basic categories of elements, additional variation and information can be added to support the requirements for complexity without dramatically changing the basic look and feel of the diagram. The four basic categories of elements are:

- Flow Objects
- Connecting Objects
- Swimlanes
- Artifacts

Flow objects are the main graphical elements to define the behavior of a Business Process. There are three Flow Objects:

- Events
- Activities
- Gateways

There are three ways of connecting the Flow Objects to each other or other information. There are three Connecting Objects:

- Sequence Flow
- Message Flow
- Association

There are two ways of grouping the primary modeling elements through “Swimlanes:”

- Pools
- Lanes

Artifacts are used to provide additional information about the Process. There are three standardized Artifacts, but modelers or modeling tools are free to add as many Artifacts as required. There may be addition BPMN efforts to standardize a larger set of Artifacts for general use or for vertical markets. The current set of Artifacts include:

- Data Object
- Group
- Annotation

Table 8.2 displays a list of the core modeling elements that are depicted by the notation.

Table 8.1 - Core Modeling Elements





| Element | Description | Notation |
|----------|---|---|
| Event | An event is something that “happens” during the course of a business process. These events affect the flow of the process and usually have a cause (trigger) or an impact (result). Events are circles with open centers to allow internal markers to differentiate different triggers or results. There are three types of Events, based on when they affect the flow: Start, Intermediate, and End. |  |
| Activity | An activity is a generic term for work that company performs. An activity can be atomic or non-atomic (compound). The types of activities that are a part of a Process Model are: Process, Sub-Process, and Task. Tasks and Sub-Processes are rounded rectangles. Processes are either unbounded or a contained within a Pool. |  |
| Gateway | A Gateway is used to control the divergence and convergence of Sequence Flow. Thus, it will determine branching, forking, merging, and joining of paths. Internal Markers will indicate the type of behavior control. |  |

Table 8.2 - BPD Core Element Set

| Element | Description | Notation |
|--|--|---|
| Sequence Flow | A Sequence Flow is used to show the order that activities will be performed in a Process. |  |
| Message Flow | A Message Flow is used to show the flow of messages between two participants that are prepared to send and receive them. In BPMN, two separate Pools in the Diagram will represent the two participants (e.g., business entities or business roles). |  |
| Association | An Association is used to associate information with Flow Objects. Text and graphical non-Flow Objects can be associated with the Flow Objects. |  |
| Pool | A Pool represents a Participant in a Process. It is also acts as a “swimlane” and a graphical container for partitioning a set of activities from other Pools, usually in the context of B2B situations. |  |
| Lane | A Lane is a sub-partition within a Pool and will extend the entire length of the Pool, either vertically or horizontally. Lanes are used to organize and categorize activities. |  |
| Data Object | Data Objects are considered Artifacts because they do not have any direct effect on the Sequence Flow or Message Flow of the Process, but they do provide information about what activities require to be performed and/or what they produce. |  |
| Group (a box around a group of objects for documentation purposes) | A grouping of activities that does not affect the Sequence Flow. The grouping can be used for documentation or analysis purposes. Groups can also be used to identify the activities of a distributed transaction that is shown across Pools. |  |
| Text Annotation (attached with an Association) | Text Annotations are a mechanism for a modeler to provide additional information for the reader of a BPMN Diagram. |  |

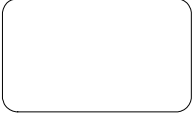
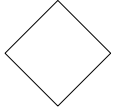
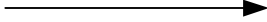
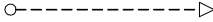
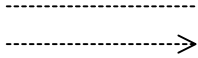
8.2 BPD Complete Set

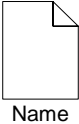
Table 8.3 displays a more extensive list of the business process concepts that could be depicted through a business process modeling notation.

Table 8.3 - BPD Complete Element Set





| Element | Description | Notation |
|---|---|---|
| Event | <p>An event is something that “happens” during the course of a business process. These events affect the flow of the process and usually have a cause (trigger) or an impact (result). There are three types of Events, based on when they affect the flow: Start, Intermediate, and End.</p> |  |
| <p>Flow Dimension (e.g., Start, Intermediate, End)</p> <p>Start (None, Message, Timer, Rule, Link, Multiple)</p> <p>Intermediate (None, Message, Timer, Error, Cancel, Compensation, Rule, Link, Multiple)</p> <p>End (None, Message, Error, Cancel, Compensation, Link, Terminate, Multiple)</p> | <p>As the name implies, the Start Event indicates where a particular process will start.</p> <p>Intermediate Events occur between a Start Event and an End Event. It will affect the flow of the process, but will not start or (directly) terminate the process.</p> <p>As the name implies, the End Event indicates where a process will end.</p> | <p>Start </p> <p>Intermediate </p> <p>End </p> |

Table 8.3 - BPD Complete Element Set



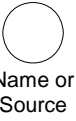







| | | |
|---|--|--|
| <p>Type Dimension (e.g., Message, Timer, Error, Cancel, Compensation, Rule, Link, Multiple, Terminate.)</p> | <p>Start and most Intermediate Events have “Triggers” that define the cause for the event. There are multiple ways that these events can be triggered. End Events may define a “Result” that is a consequence of a Sequence Flow ending.</p> | <p>Message </p> <p>Timer </p> <p>Error </p> <p>Cancel </p> <p>Compensation </p> <p>Rule </p> <p>Link </p> <p>Multiple </p> <p>Terminate </p> |
| <p>Task (Atomic)</p> | <p>A Task is an atomic activity that is included within a Process. A Task is used when the work in the Process is not broken down to a finer level of Process Model detail.</p> |  |
| <p>Process/Sub-Process (non-atomic)</p> | <p>A Sub-Process is a compound activity that is included within a Process. It is compound in that it can be broken down into a finer level of detail (a Process) through a set of sub-activities.</p> | <p>See Next Two Figures</p> |
| <p>Collapsed Sub-Process</p> | <p>The details of the Sub-Process are not visible in the Diagram. A “plus” sign in the lower-center of the shape indicates that the activity is a Sub-Process and has a lower-level of detail.</p> |  |
| <p>Expanded Sub-Process</p> | <p>The boundary of the Sub-Process is expanded and the details (a Process) are visible within its boundary. Note that Sequence Flow cannot cross the boundary of a Sub-Process.</p> |  |

Table 8.3 - BPD Complete Element Set







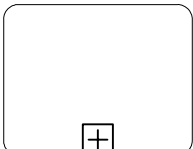
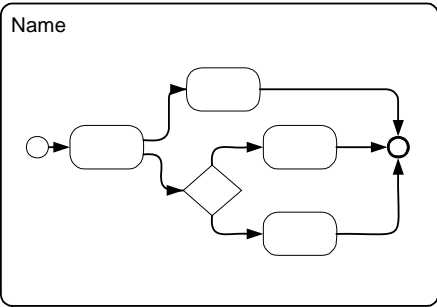

| | | |
|------------------------------|--|--|
| <p>Gateway</p> | <p>A Gateway is used to control the divergence and convergence of multiple Sequence Flow. Thus, it will determine branching, forking, merging, and joining of paths.</p> |  |
| <p>Gateway Control Types</p> | <p>Icons within the diamond shape will indicate the type of flow control behavior. The types of control include:</p> <ul style="list-style-type: none"> • XOR -- exclusive decision and merging. Both Data-Based and Event-Based. Data-Based can be shown with or without the “X” marker. • OR -- inclusive decision and merging • Complex -- complex conditions and situations (e.g., 3 out of 5) • AND -- forking and joining <p>Each type of control affects both the incoming and outgoing Flow.</p> | <p>Exclusive (XOR) Data-Based  or  Event-Based  Inclusive (OR)  Complex  Parallel (AND) </p> |
| <p>Sequence Flow</p> | <p>A Sequence Flow is used to show the order that activities will be performed in a Process.</p> | <p>See next seven figures</p> |
| <p>Normal Flow</p> | <p>Normal Sequence Flow refers to the flow that originates from a Start Event and continues through activities via alternative and parallel paths until it ends at an End Event.</p> |  |
| <p>Uncontrolled flow</p> | <p>Uncontrolled flow refers to flow that is not affected by any conditions or does not pass through a Gateway. The simplest example of this is a single Sequence Flow connecting two activities. This can also apply to multiple Sequence Flow that converge on or diverge from an activity. For each uncontrolled Sequence Flow a “Token” will flow from the source object to the target object.</p> |  |

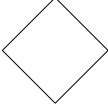
Table 8.3 - BPD Complete Element Set

| | | |
|---------------------------------|--|---|
| <p>Conditional flow</p> | <p>Sequence Flow can have condition expressions that are evaluated at runtime to determine whether or not the flow will be used. If the conditional flow is outgoing from an activity, then the Sequence Flow will have a mini-diamond at the beginning of the line (see figure to the right). If the conditional flow is outgoing from a Gateway, then the line will not have a mini-diamond (see figure in the row above).</p> |  |
| <p>Default flow</p> | <p>For Data-Based Exclusive Decisions or Inclusive Decisions, one type of flow is the Default condition flow. This flow will be used only if all the other outgoing conditional flow is not true at runtime. These Sequence Flow will have a diagonal slash will be added to the beginning of the line (see the figure to the right).</p> |  |
| <p>Exception Flow</p> | <p>Exception Flow occurs outside the Normal Flow of the Process and is based upon an Intermediate Event that occurs during the performance of the Process.</p> |  |
| <p>Message Flow</p> | <p>A Message Flow is used to show the flow of messages between two entities that are prepared to send and receive them. In BPMN, two separate Pools in the Diagram will represent the two entities.</p> |  |
| <p>Compensation Association</p> | <p>Compensation Association occurs outside the Normal Flow of the Process and is based upon an event (a Cancel Intermediate Event) that is triggered through the failure of a Transaction or a Compensate Event. The target of the Association must be marked as a Compensation Activity.</p> |  |

Table 8.3 - BPD Complete Element Set

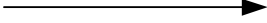

| | | |
|--|--|--|
| <p>Data Object</p> | <p>Data Objects are considered Artifacts because they do not have any direct effect on the Sequence Flow or Message Flow of the Process, but they do provide information about what activities require to be performed and/or what they produce.</p> |  |
| <p>Fork (AND-Split)</p> | <p>BPMN uses the term “fork” to refer to the dividing of a path into two or more parallel paths (also known as an AND-Split). It is a place in the Process where activities can be performed concurrently, rather than sequentially. There are two options: Multiple Outgoing Sequence Flow can be used (see figure top-right). This represents “uncontrolled” flow is the preferred method for most situations. A Parallel (AND) Gateway can be used (see figure bottom-right). This will be used rarely, usually in combination with other Gateways.</p> |  |
| <p>Join (AND-Join)</p> | <p>BPMN uses the term “join” to refer to the combining of two or more parallel paths into one path (also known as an AND-Join or synchronization). A Parallel (AND) Gateway is used to show the joining of multiple Flow.</p> |  |
| <p>Decision, Branching Point; (OR-Split)</p> | <p>Decisions are Gateways within a business process where the flow of control can take one or more alternative paths.</p> | <p>See next five rows.</p> |
| <p>Exclusive</p> | <p>An Exclusive Gateway (XOR) restricts the flow such that only one of a set of alternatives may be chosen during runtime. There are two types of Exclusive Gateways: Data-based and Event-based.</p> | <p>Data-Based  or  Event-Based </p> |

Table 8.3 - BPD Complete Element Set

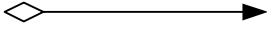
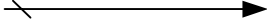
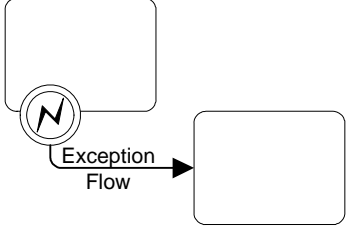
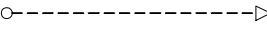
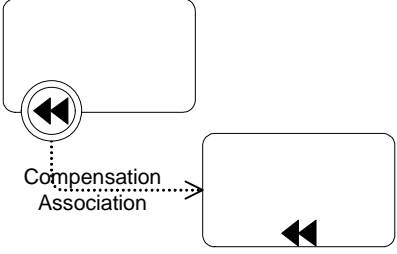
| | | |
|---------------------------|---|--|
| <p>Data-Based</p> | <p>This Decision represents a branching point where Alternatives are based on conditional expressions contained within the outgoing Sequence Flow. Only one of the Alternatives will be chosen.</p> |  |
| <p>Event-Based</p> | <p>This Decision represents a branching point where Alternatives are based on an Event that occurs at that point in the Process. The specific Event, usually the receipt of a Message, determines which of the paths will be taken. Other types of Events can be used, such as Timer. Only one of the Alternatives will be chosen. There are two options for receiving Messages: Tasks of Type Receive can be used (see figure top-right). Intermediate Events of Type Message can be used (see figure bottom-right).</p> |  |

Table 8.3 - BPD Complete Element Set

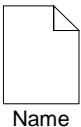
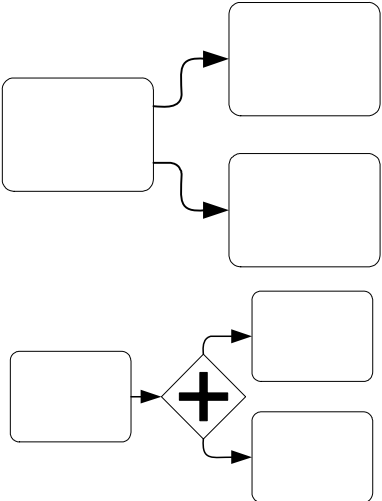
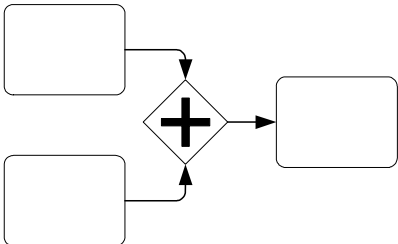
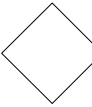
| | | |
|--------------------------|---|-----------------------------|
| <p>Inclusive</p> | <p>This Decision represents a branching point where Alternatives are based on conditional expressions contained within the outgoing Sequence Flow.</p> <p>In some sense it is a grouping of related independent Binary (Yes/No) Decisions. Since each path is independent, all combinations of the paths may be taken, from zero to all. However, it should be designed so that at least one path is taken. A Default Condition could be used to ensure that at least one path is taken. There are two versions of this type of Decision:</p> <p>The first uses a collection of conditional Sequence Flow, marked with mini-diamonds (see top-right figure).</p> <p>The second uses an OR Gateway, usually in combination with other Gateways (see bottom-right picture).</p> | |
| <p>Merging (OR-Join)</p> | <p>BPMN uses the term “merge” to refer to the exclusive combining of two or more paths into one path (also known as an a OR-Join).</p> <p>A Merging (XOR) Gateway is used to show the merging of multiple Flow.</p> <p>If all the incoming flow is alternative, then a Gateway is not needed. That is, uncontrolled flow provides the same behavior.</p> | |
| <p>Looping</p> | <p>BPMN provides 2 (two) mechanisms for looping within a Process.</p> | <p>See Next Two Figures</p> |
| <p>Activity Looping</p> | <p>The attributes of Tasks and Sub-Processes will determine if they are repeated or performed once. There are two types of loops: Standard and Multi-Instance. A small looping indicator will be displayed at the bottom-center of the activity.</p> | |

Table 8.3 - BPD Complete Element Set



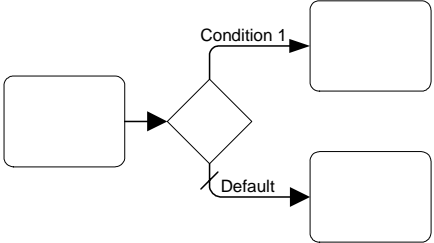
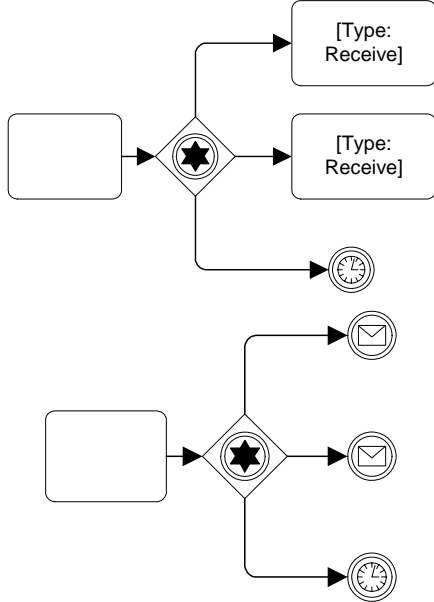



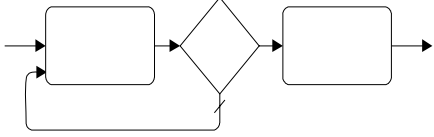

| | | |
|--|--|---|
| <p>Sequence Flow Looping</p> | <p>Loops can be created by connecting a Sequence Flow to an “upstream” object. An object is considered to be upstream if that object has an outgoing Sequence Flow that leads to a series of other Sequence Flow, the last of which is an incoming Sequence Flow for the original object.</p> |  |
| <p>Multiple Instances</p> | <p>The attributes of Tasks and Sub-Processes will determine if they are repeated or performed once. A small parallel indicator will be displayed at the bottom-center of the activity.</p> |  |
| <p>Process Break (something out of the control of the process makes the process pause)</p> | <p>A Process Break is a location in the Process that shows where an expected delay will occur within a Process. An Intermediate Event is used to show the actual behavior (see top-right figure). In addition, a Process Break Artifact, as designed by a modeler or modeling tool, can be associated with the Event to highlight the location of the delay within the flow.</p> |  |
| <p>Transaction</p> | <p>A transaction is a Sub-Process that is supported by special protocol that insures that all parties involved have complete agreement that the activity should be completed or cancelled. The attributes of the activity will determine if the activity is a transaction. A double-lined boundary indicates that the Sub-Process is a Transaction.</p> |  |
| <p>Nested/Embedded Sub-Process (Inline Block)</p> | <p>A nested (or embedded) Sub-Process is an activity that shares the same set of data as its parent process. This is opposed to a Sub-Process that is independent, reusable, and referenced from the parent process. Data needs to be passed to the referenced Sub-Process, but not to the nested Sub-Process.</p> | <p>There is no special indicator for nested Sub-Processes</p> |

Table 8.3 - BPD Complete Element Set

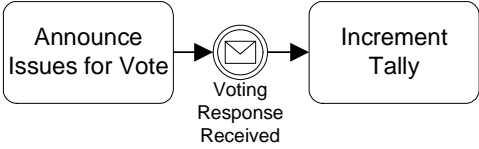
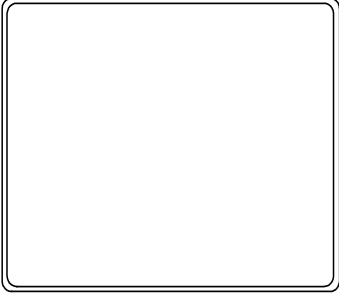
| | | |
|---|--|---|
| <p>Group (a box around a group of objects for documentation purposes)</p> | <p>A grouping of activities that does not affect the Sequence Flow. The grouping can be used for documentation or analysis purposes. Groups can also be used to identify the activities of a distributed transaction that is shown across Pools.</p> |  |
| <p>Off-Page Connector</p> | <p>Generally used for printing, this object will show where the Sequence Flow leaves one page and then restarts on the next page. A Link Intermediate Event can be used as an Off-Page Connector.</p> |  |
| <p>Association</p> | <p>An Association is used to associate information with Flow Objects. Text and graphical non-Flow Objects can be associated with the Flow Objects.</p> |  |
| <p>Text Annotation (attached with an Association)</p> | <p>Text Annotations are a mechanism for a modeler to provide additional information for the reader of a BPMN Diagram.</p> |  |
| <p>Pool</p> | <p>A Pool represents a Participant in a Process. It is also acts as a “swimlane” and a graphical container for partitioning a set of activities from other Pools, usually in the context of B2B situations.</p> |  |
| <p>Lanes</p> | <p>A Lane is a sub-partition within a Pool and will extend the entire length of the Pool, either vertically or horizontally. Lanes are used to organize and categorize activities within a Pool.</p> |  |

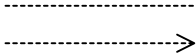
8.3 Use of Text, Color, Size, and Lines in a Diagram

Text Annotation objects can be used by the modeler to display additional information about a Process or attributes of the objects within the Process.

- Flow objects and Flow MAY have labels (e.g., its name and/or other attributes) placed inside the shape, or above or below the shape, in any direction or location, depending on the preference of the modeler or modeling tool vendor.
- The fills that are used to for the graphical elements MAY be white or clear.
 - The notation MAY be extended to use other fill colors to suit the purpose of the modeler or tool (e.g., to highlight the value of an object attribute).
- Flow objects and markers MAY be of any size that suits the purposes of the modeler or modeling tool.

- The lines that are used to draw the graphical elements MAY be black.
 - The notation MAY be extended to use other line colors to suit the purpose of the modeler or tool (e.g., to highlight the value of an object attribute).
 - The notation MAY be extended to use other line styles to suit the purpose of the modeler or tool (e.g., to highlight the value of an object attribute) with the condition that the line style MUST NOT conflict with any current BPMN defined line style. Thus, the line styles of Sequence Flow, Message Flow, and Associations MUST NOT be modified.













8.4 Flow Object Connection Rules

An incoming Sequence Flow can connect to any location on a Flow Object (left, right, top, or bottom). Likewise, an outgoing Sequence Flow can connect from any location on a Flow Object (left, right, top, or bottom). Message Flow also have this capability. BPMN allows this flexibility, however, we also recommend that modelers use judgment or best practices in how Flow Objects should be connected so that readers of the Diagrams will find the behavior clear and easy to follow. This is even more important when a Diagram contains Sequence Flow and Message Flow. In these situations it is best to pick a direction of Sequence Flow, either left to right or top to bottom, and then direct the Message Flow at a 90° angle to the Sequence Flow. The resulting Diagrams will be much easier to understand.

8.4.1 Sequence Flow Rules

Table 8.4 displays the BPMN Flow Objects and shows how these objects can connect to one another through Sequence Flow. The ↗ symbol indicates that the object listed in the row can connect to the object listed in the column. The quantity of connections into and out of an object is subject to various configuration dependencies are not specified here. Refer to the sections in the next chapter for each individual object for more detailed information on the appropriate connection rules. *Note that if a sub-process has been expanded within a Diagram, the objects within the sub-process cannot be connected to objects outside of the sub-process. Nor can Sequence Flow cross a Pool boundary.*

Table 8.4 - Sequence Flow Connection Rules













| From\To |  |  |  |  |  |  |
|---|---|---|---|--|---|---|
|  | | ↗ | ↗ | ↗ | ↗ | ↗ |
|  | | ↗ | ↗ | ↗ | ↗ | ↗ |
|  | | ↗ | ↗ | ↗ | ↗ | ↗ |
|  | | ↗ | ↗ | ↗ | ↗ | ↗ |
|  | | ↗ | ↗ | ↗ | ↗ | ↗ |
|  | | | | | | |

Note – Only those objects that can have incoming and/or outgoing Sequence Flow are shown in the table. Thus, Pool, Lane, Data Object, and Text Annotation are not listed in the table.

8.4.2 Message Flow Rules

Table 8.5 displays the BPMN modeling objects and shows how these objects can connect to one another through Message Flow. The ↗ symbol indicates that the object listed in the row can connect to the object listed in the column. The quantity of connections into and out of an object is subject to various configuration dependencies are not specified here. Refer to the sections in the next chapter for each individual object for more detailed information on the appropriate connection rules. *Note that Message Flow cannot connect to objects that are within the same Participant Lane boundary.*

Table 8.5 - Message Flow Connection Rules

| From\To |  |  |  |  |  |  |
|---|---|---|---|---|---|---|
|  | | | | | | |
|  | ↗ | ↗ | ↗ | ↗ | ↗ | |
|  | ↗ | ↗ | ↗ | ↗ | ↗ | |
|  | ↗ | ↗ | ↗ | ↗ | ↗ | |
|  | | | | | | |
|  | ↗ | ↗ | ↗ | ↗ | ↗ | |

Note – Only those objects that can have incoming and/or outgoing Message Flow are shown in the table. Thus, Lane, Gateway, Data Object, and Text Annotation are not listed in the table.

8.5 Business Process Diagram Attributes

The following table displays the set of attributes of a Business Process Diagram:

Table 8.6 - Business Process Diagram Attributes

| Attributes | Description |
|-------------------------------|---|
| Id: Object | This is a unique Id that distinguishes the Diagram from other Diagrams. |
| Name: String | Name is an attribute that is text description of the Diagram. |
| Version (0-1) : String | This defines the Version number of the Diagram. |

Table 8.6 - Business Process Diagram Attributes

| Attributes | Description |
|--|---|
| Author (0-1) : String | This holds the name of the author of the Diagram. |
| Language (0-1) : String | This holds the name of the language in which text is written. The default is English. |
| ExpressionLanguage (0-1) : String | A Language MAY be provided so that the syntax of expressions used in the Diagram can be understood. |
| QueryLanguage (0-1) : String | A Language MAY be provided so that the syntax of queries used in the Diagram can be understood. |
| CreationDate (0-1) : Date | This defines the date on which the Diagram was created (for the current Version). |
| ModificationDate (0-1) : Date | This defines the date on which the Diagram was last modified (for this Version). |
| Pools (1-n) : Pool | A BPD SHALL contain one or more Pools. The boundary of one of the Pools MAY be invisible (especially if there is only one Pool in the Diagram). Refer to the Section B.8.2, “Pool,” on page 263 for more information about Pools. |
| Documentation (0-1) : String | The modeler MAY add optional text documentation about the Diagram. |

8.5.1 Changes Since 1.0 Draft Version

These are the changes since the last publicly released version:

- The Id attribute, within the set of Business Process Diagram attributes, was changed to be of type Object.
- The ModificationDate, ExpressionLanguage, and QueryLanguage attributes were added to the set of Diagram attributes.
- The cardinality of the Version, Author, CreationDate, and ModificationDate attributes, within the set of Business Process Diagram attributes, was changed from 0 to 1.
- The Process attribute was removed from the set of Diagram attributes. The attribute was redundant with the Pool attribute, which will refer to all the Processes in the Diagram.

8.6 Processes

A **Process** is an activity performed within a company or organization. In BPMN a Process is depicted as a graph of Flow Objects, which are a set of other activities and the controls that sequence them. The concept of process is intrinsically hierarchical. Processes may be defined at any level from enterprise-wide processes to processes performed by a single person. Low-level processes may be grouped together to achieve a common business goal.

Note that BPMN defines the term Process fairly specifically and defines a Business Process more generically as a set of activities that are performed within an organization or across organizations. Thus a Business Process, as shown in a Business Process Diagram, may contain more than one separate Process. Each Process may have its own Sub-Processes and would be contained within a Pool (Section B.8.2, “Pool,” on page 263). The individual Processes would be independent in terms of Sequence Flow, but could have Message Flow connecting them.

8.6.1 Attributes

The following table displays the set of attributes of a Process:

Table 8.7 - Process Attributes

| Attributes | Description |
|---|--|
| Id: Object | This is a unique Id that identifies the object from other objects within the Diagram. |
| Name: String | Name is an attribute that is text description of the object. |
| ProcessType (None Private Abstract Collaboration) None : String | ProcessType is an attribute that provides information about which lower-level language the Pool will be mapped. By default, the ProcessType is None (or undefined). A Private ProcessType MAY be mapped to an executable BPEL4WS <i>process</i> . An Abstract ProcessType is also called the public interface of a process (or other web services) and MAY be mapped to an abstract BPEL4WS <i>process</i> . A Collaboration ProcessType will have two Lanes that represent business roles (e.g., buyer or seller) and will show the interactions between these roles. These Pools MAY be mapped to languages such as ebXML or WS Choreography. However, these mappings are not provided in this version of the specification. If the Process is to be used to create a BPEL4WS document, then the attribute MUST be set to Executable or Abstract. |
| Status (None Ready Active Cancelled Aborting Aborted Completing Completed) None : String | The Status of a Process is determined when the Process is being executed by a process engine. The Status of a Process can be used within Assignment Expressions. |
| GraphicalElements (0-n) : Object | The GraphicalElements attribute identifies all of the objects (e.g., Events, Activities, Gateways, and Artifacts) that are contained within the Business Process. |
| Assignments (0-n) : Assignment | One or more assignment expressions MAY be made for the object. The Assignment SHALL be performed as defined by the AssignTime attribute. The details of the Assignment is defined in the Section B.11.1, "Assignment," on page 268. |
| Properties (0-n) : Property | Modeler-defined Properties MAY be added to a Process. These Properties are "local" to the Process. All Tasks, Sub-Process objects, and Sub-Processes that are embedded SHALL have access to these Properties. The fully delineated name of these properties are "<process name>.<property name>" (e.g., "Add Customer.Customer Name"). If a process is embedded within another Process, then the fully delineated name SHALL also be preceded by the Parent Process name for as many Parents there are until the top level Process. Further details about the definition of a Property can be found in the Section B.11.7, "Property," on page 270. |

Table 8.7 - Process Attributes

| Attributes | Description |
|--|--|
| AdHoc False : Boolean | AdHoc is a boolean attribute, which has a default of False. This specifies whether the Process is Ad Hoc or not. The activities within an Ad Hoc Process are not controlled or sequenced in a particular order, their performance is determined by the performers of the activities. If set to True, then the Ad Hoc marker SHALL be placed at the bottom center of the Process or the Sub-Process shape for Ad Hoc Processes. |
| [AdHoc = True only] AdHocOrdering (0-1) (Sequential Parallel) Parallel : String | If the Process is Ad Hoc (the AdHoc attribute is True), then the AdHocOrdering attribute MUST be included. This attribute defines if the activities within the Process can be performed in Parallel or must be performed sequentially. The default setting is Parallel and the setting of Sequential is a restriction on the performance that may be required due to shared resources. |
| [AdHoc = True only] AdHocCompletionCondition (0-1) : Expression | If the Process is Ad Hoc (the AdHoc attribute is True), then the AdHocCompletionCondition attribute MUST be included. This attribute defines the conditions when the Process will end. |
| SuppressJoinFailure False : Boolean | This attribute is included for mapping to BPEL4WS. This specifies whether or not a BPEL4WS joinFailure fault will be suppressed for all activities in the BPEL4WS process. |
| EnableInstanceCompensation False : Boolean | This attribute is included for mapping to BPEL4WS. It specifies whether or not a compensation can be performed after the Process has completed normally. |
| Categories (0-n) : String | The modeler MAY add one or more defined Categories that can be used for purposes such as reporting and analysis. |
| Documentation (0-1) : String | The modeler MAY add text documentation about the Process. |

8.6.2 Changes Since 1.0 Draft Version

These are the changes since the last publicly released version:

- The set of Process attributes was decoupled from the set of common Flow Object attributes. This was done since some of the Common attributes, such as Pool and Lane, did not apply to a Process.
- The Id, Name, ProcessType, GraphicalElements, Assignments, AdHocOrdering, Categories, SuppressJoinFailure, EnableInstanceCompensation, and Document attributes were added to the set of Process attributes.
- The Property attribute, within the set of Process Attributes, was renamed to Properties and defined as type Property.
- The AdHocCompletionCondition attribute, within the set of Process attributes, was changed to an option attribute.
- The Name and Type attributes were removed from the set of Process attributes. These attributes can be found in the definition of a Property, which can be found in the section “Property” on page 270.
- The PassThrough attribute was removed from the set of Process attributes. Link type of Start, End, and Intermediate Events provide this functionality.

9 Business Process Diagram Graphical Objects

This section details the graphical representation and the semantics of the behavior of Business Process Diagram graphical elements. “Mapping to BPEL4WS” on page 137 for more information about how these elements map to execution languages.

9.1 Common Graphical Object Attributes

The following table displays a set of common attributes for BPMN graphical objects (Flow Objects, Swimlanes, Artifacts, and Connecting Objects):

Table 9.1 - Common Graphical Object Attributes

| Attributes | Description |
|-------------------------------------|--|
| Id : Object | This is a unique Id that identifies the object from other objects within the Diagram. |
| Categories (0-n) : String | The modeler MAY add one or more defined Categories that can be used for purposes such as reporting and analysis. |
| Documentation (0-1) : String | The modeler MAY add text documentation about the object. |

Changes Since 1.0 Draft Version

These are the changes since the last publicly released version:

- The set of common set of graphical object attributes was added.
- The Id and Documentation attributes were moved from other attribute sets to the list of common graphical object attributes.
- The Id attributes, within the set of common graphical object attributes, was changed to be of type Object.
- The Categories attribute was added to the set of common graphical object attributes.
- Throughout the specification, attributes that were defined as being of type “(True | False)” were changed to type “boolean.”

9.2 Common Flow Object Attributes

The following table displays a set of common attributes for BPMN Flow Objects (Events, Activities, and Gateways), and which extends the set of common graphical object attributes (see Table 9.1):

Table 9.2 - Common Flow Object Attributes

| Attributes | Description |
|----------------------|--|
| Name : String | Name is an attribute that is text description of the object. |

Table 9.2 - Common Flow Object Attributes

| Attributes | Description |
|---------------------------------------|---|
| Assignments (0-n) : Assignment | One or more assignment expressions MAY be made for the object. For activities (Task, Sub-Process, and Process), the Assignment SHALL be performed as defined by the AssignTime attribute. The Details of the Assignment is defined in Section B.11.1, “Assignment,” on page 268. |
| Pool : Pool | A Pool MUST be identified for the object to identify its location. The attributes of a Pool can be found in Section 9.6.2, “Pool,” on page 87. |
| Lanes (0-n) : Lane | If the Pool (which can be determined through the Pool that the Process has been assigned to) has more than one Lane, then the Id of at least one Lane MUST be added. There MAY be multiple Lanes listed if the Lanes are organized in matrix or overlap in a non-nested manner, The attributes of a Lane can be found in Section 9.6.3, “Lane,” on page 90. |

9.2.1 Changes Since 1.0 Draft Version

These are the changes since the last publicly released version:

- The Pool attributes, within the set of common Flow Object attributes, was changed to be of type Pool.
- The Lanes attributes, within the set of common Flow Object attributes, was changed to be of type Lane.

9.3 Events

An Event is something that “happens” during the course of a business process. These Events affect the flow of the Process and usually have a cause or an impact. The term “event” is general enough to cover many things in a business process. The start of an activity, the end of an activity, the change of state of a document, a message that arrives, etc., all could be considered events. However, BPMN has restricted the use of events to include only those types of events that will affect the sequence or timing of activities of a process. BPMN further categorizes Events into three main types: Start, Intermediate, and End.

Start and most Intermediate Events have “Triggers” that define the cause for the event. There are multiple ways that these events can be triggered (“Start Event Triggers” on page 37 and “Intermediate Event Triggers” on page 44). End Events may define a “Result” that is a consequence of a Sequence Flow ending. There are multiple types of Results that can be defined (“End Event Results” on page 41).

All Events share the same shape footprint, a small circle. Different line styles, as shown below, distinguish the three types of flow Events. All Events also have an open center so that BPMN-defined and modeler-defined icons can be included within the shape to help identify the Trigger or Result of the Event.

9.3.1 Common Event Attributes

The following table displays the set of attributes common to the three types of Events, and which extends the set of common Flow Object attributes (see Table 9.2):

Table 9.3 - Common Event Attributes

| Attributes | Description |
|--|--|
| EventType (Start End Intermediate) Start : String | The EventType MUST be of type Start, End, or Intermediate. |

Changes Since 1.0 Draft Version

These are the changes since the last publicly released version:

- The set of common set of Event attributes was added.
- The EventType attribute was added to the set of common Event attributes.

9.3.2 Start

As the name implies, the Start Event indicates where a particular Process will start. In terms of Sequence Flow, the Start Event starts the flow of the Process, and thus, will not have any incoming Sequence Flow—no Sequence Flow can connect to a Start Event.

The Start Event shares the same basic shape of the Intermediate Event and End Event, a circle with an open center so that markers can be placed within the circle to indicate variations of the Event.

- ◆ A Start Event is a circle that MUST be drawn with a single thin line (see Figure 9.1).
- ◆ The use of text, color, size, and lines for a Start Event MUST follow the rules defined in Section 8.3, “Use of Text, Color, Size, and Lines in a Diagram,” on page 26 with the exception that:
 - ◆ The thickness of the line MUST remain thin so that the Start Event may be distinguished from the Intermediate and End Events.



Figure 9.1 - A Start Event

Throughout this document, we will discuss how Sequence Flow proceeds within a Process. To facilitate this discussion, we will employ the concept of a “**Token**” that will traverse the Sequence Flow and pass through the Flow Objects in the Process. The behavior of the Process can be described by tracking the path(s) of the Token through the Process. A Token will have a unique identity, called a TokenId set, that can be used to distinguish multiple Tokens that may exist because of concurrent Process instances or the dividing of the Token for parallel processing within a single Process instance. The parallel dividing of a Token creates a lower level of the TokenId set. The set of all levels of TokenId will identify a Token.

A Start Event generates a Token that must eventually be consumed at an End Event (which may be implicit if not graphically displayed). The path of Tokens should be traceable through the network of Sequence Flow, Gateways, and activities within a Process. There MUST NOT be any implicit flow during the course of normal Sequence Flow (i.e., there

should always be either Sequence Flow or a graphical indicator, such as an Intermediate Event to show all the potential paths of Tokens). An example of implicit flow is when a Token arrives at a Gateway, but none of the Gates are valid, the Token would then (implicitly) pass to the end of the Process, which occurs with some modeling notations. Tokens can also be directed through exception handling Intermediate Events, which act like a forced end to an activity. Note: A Token does not traverse the Message Flow since it is a Message that is passed down those Flow (as the name implies).

Semantics of the Start Event include:

- ◆ A Start Event is **OPTIONAL**: a Process level—a top-level Process or an expanded Sub-Process—**MAY** (is not required to) have a Start Event:

Note – A BPD may have more than one Process level (i.e., it can include Expanded Sub-Processes). The use of Start and End Events is independent for each level of the Diagram.

- ◆ If a Process is complex and/or the starting conditions are not obvious, then it is **RECOMMENDED** that a Start Event be used.
- ◆ If there is an End Event, then there **MUST** be at least one Start Event.
- ◆ If the Start Event is used, then there **MUST NOT** be other flow elements that do not have incoming Sequence Flow—all other Flow Objects **MUST** be a target of at least one Sequence Flow.
 - ◆ Exceptions to this are activities that are defined as being Compensation activities (have the Compensation Marker). Compensation activities **MUST NOT** have any incoming Sequence Flow, even if there is a Start Event in the Process level. See Section 10.3, “Compensation Association,” on page 133 for more information on Compensation activities.
 - ◆ An exception to this is the Intermediate Event, which **MAY** be without an incoming Sequence Flow (when attached to an activity boundary).
- ◆ If the Start Event is *not* used, then all Flow Objects that do not have an incoming Sequence Flow (i.e., are not a target of a Sequence Flow) **SHALL** be instantiated when the Process is instantiated. There is an assumption that there is only one implicit Start Event, meaning that all the starting Flow Objects will start at the same time.
 - ◆ Exceptions to this are activities that are defined as being Compensation activities (have the Compensation Marker). Compensation Activities are not considered a part of the Normal Flow and **MUST NOT** be instantiated when the Process is instantiated.
- ◆ There **MAY** be multiple Start Events for a given Process level.
 - ◆ Each Start Event is an independent event. That is, a Process Instance **SHALL** be generated when the Start Event is triggered.

Note – The behavior of Process may be harder to understand if there are multiple Start Events. It is **RECOMMENDED** that this feature be used sparingly and that the modeler be aware that other readers of the Diagram may have difficulty understanding the intent of the Diagram.

When the trigger for a Start Event occurs, Tokens will be generated for each outgoing Sequence Flow from that event. The TokenId set for each of the Tokens will be established such that it can be identified that the Tokens are all from the same parallel Fork (AND-Split) and the number of Tokens in the group. These Tokens will begin their flow and not wait for any other Start Event to be triggered.

If there is a dependency for more than one Event to happen before a Process can start (e.g., two messages are required to start), then the Start Events must flow to the same activity within that Process. The attributes of the activity would specify when the activity could begin. If the attributes specify that the activity must wait for all inputs, then all Start Events will







have to be triggered before the Process begins (“Attributes” on page 38 (for sub-processes) and “Attributes” on page 64 (for Tasks) for more information about activity attributes). In addition, a correlation mechanism will be required so that different triggered Start Events will apply to the same process instance. Correlation will likely be handled through Event attributes, but this open issue will be addressed in a later version of the specification. Refer to Annex D for a complete list of the issues open for BPMN.

Start Event Triggers

There are many ways that business process can be started (instantiated). The Trigger for a Start Event is designed to show the general mechanism that will instantiate that particular Process. There are six types of Start Events in BPMN: None, Message, Timer, Rule, Link, and Multiple.

Table 9.4 displays the types of Triggers and the graphical marker that will be used for each:

Table 9.4 - Start Event Types

| Trigger | Description | Marker |
|----------|--|---|
| None | The modeler does not display the type of Event. It is also used for a Sub-Process that starts when the flow is triggered by its Parent Process. |  |
| Message | A message arrives from a participant and triggers the start of the Process. |  |
| Timer | A specific time-date or a specific cycle (e.g., every Monday at 9am) can be set that will trigger the start of the Process. |  |
| Rule | This type of event is triggered when the conditions for a rule such as “S&P 500 changes by more than 10% since opening,” or “Temperature above 300C” become true. |  |
| Link | A Link is a mechanism for connecting the end (Result) of one Process to the start (Trigger) of another. Typically, these are two Sub-Processes within the same parent Process. |  |
| Multiple | This means that there are multiple ways of triggering the Process. Only one of them will be required to start the Process. The attributes of the Start Event will define which of the other types of Triggers apply. |  |

Attributes

The following table displays the set of attributes of a Start Event, which extends the set of common Event attributes (see Table 9.5):

Table 9.5 - Start Event Attributes

| Attributes | Description |
|---|--|
| Trigger (None Message Timer Rule Link Multiple) None : String | Trigger is an attribute (default None) that defines the type of trigger expected for that Start. The next eight (8) rows define the attributes that are required for each of the Trigger types. The Trigger list MAY be extended to include new types. These new Triggers MAY have a new modeler- or tool-defined Marker to fit within the boundaries of the Event. |
| [Message Trigger only] Message : Message | If the Trigger is a Message, then the a Message MUST be supplied. The attributes of a Message can be found in Section B.11.4, “Message,” on page 269. |
| [Message Trigger only] Implementation (Web Service Other Unspecified) Web Service | This attribute specifies the technology that will be used to receive the message. A Web service is the default technology. |
| [Timer Trigger only] TimeDate (0-1) : Date | If the Trigger is a Timer, then a TimeDate MAY be entered. If a TimeDate is not entered, then a TimeCycle MUST be entered (see the attribute below). |
| [Timer Trigger only] TimeCycle (0-1) : String | If the Trigger is a Timer, then a TimeCycle MAY be entered. If a TimeCycle is not entered, then a TimeDate MUST be entered (see the attribute above). |
| [Rule Trigger only] RuleName : Rule | If the Trigger is a Rule, then a Rule MUST be entered. The attributes of a Rule can be found in Section B.11.9, “Rule,” on page 271. |
| [Link Trigger only] LinkId : String | If the Trigger is a Link, then the LinkId MUST be entered. |
| [Link Trigger only] ProcessRef : Process | If the Trigger is a Link, then the ProcessRef MUST be entered. The identified Process MAY be the same Process as that of the Link Event. |
| [Multiple Trigger only] Triggers (2-n) : Trigger | If the Trigger attribute is a Multiple, then a list of two or more Triggers MUST be provided. Each Trigger MUST have the appropriate data (as defined above). The Trigger MUST NOT be of type None or Multiple. |

Sequence Flow Connections

See Section 8.4.1, “Sequence Flow Rules,” on page 27 for the entire set of objects and how they may be source or targets of Sequence Flow.

- ◆ A Start Event MUST NOT be a target for Sequence Flow; it MUST NOT have incoming Sequence Flow.
 - ◆ An exception to this is when a Start Event is used in an Expanded Sub-Process and is attached to the boundary of that Sub-Process. In this case, a Sequence Flow from the higher-level Process MAY connect to that Start Event in lieu of connecting to the actual boundary of the Sub-Process (see Figure 10.16).
- ◆ A Start Event MUST be a source for Sequence Flow.
- ◆ Multiple Sequence Flow MAY originate from a Start Event. For each Sequence Flow that has the Start Event as a source, a new parallel path SHALL be generated.

- ◆ The Condition attribute for all outgoing Sequence Flow MUST be set to None.
- ◆ When a Start Event is not used, then all Flow Objects that do not have an incoming Sequence Flow SHALL be the start of a separate parallel path.

Each path will have a separate unique Token that will traverse the Sequence Flow.

Message Flow Connections

See Section 8.4.2, “Message Flow Rules,” on page 28 for the entire set of objects and how they may be source or targets of Message Flow.

Note – All Message Flow must connect two separate Pools. They can connect to the Pool boundary or to Flow Objects within the Pool boundary. They cannot connect two objects within the same Pool.

- ◆ A Start Event MAY be the target for Message Flow; it can have 0 (zero) or more incoming Message Flow. Each Message Flow arriving at a Start Event represents an instantiation mechanism (a Trigger) for the process. Only one of the Triggers is required to start a new Process.
 - ◆ The Trigger attribute of the Start Event MUST be set to “Message” or “Multiple” if there are any incoming Message Flow.
 - ◆ The Trigger attribute of the Start Event MUST be set to “Multiple” if there are more than one incoming Message Flow.
- ◆ A Start Event MUST NOT be a source for Message Flow; it MUST NOT have outgoing Message Flow.

Changes Since 1.0 Draft Version

These are the changes since the last publicly released version:

- The constraint about the fill of the Event was removed.
- The attribute table was reorganized to make it more clear that some attributes applied only if the Trigger attribute was set to specific values.
- The Message attribute, within the set of the Start Event attributes, was changed to be of type Message.
- The RuleExpression attribute, within the set of the Start Event attributes, was renamed to RuleName and was changed to be of type Rule.
- The LinkName attribute, within the set of the Start Event attributes, was renamed to LinkId and was changed to be of type String.
- The Implementation and ProcessRef attributes were added to the list of Start Event attributes.
- The attribute for a Timer Event, within the set of the Start Event attributes, was divided into two separate attributes. One is TimeDate and the other is TimeCycle.
- The cardinality of the list of Triggers for the Multiple Trigger was modified so that it is now 2 or more.
- Within the Message Flow Connections section, it was clarified that if there are multiple incoming Message Flow, then the Trigger must be Multiple.

9.3.3 End

As the name implies, the End Event indicates where a process will end. In terms of Sequence Flow, the End Event ends the flow of the Process, and thus, will not have any outgoing Sequence Flow—no Sequence Flow can connect from an End Event.

The End Event shares the same basic shape of the Start Event and Intermediate Event, a circle with an open center so that markers can be placed within the circle to indicate variations of the Event.

- ◆ An End Event is a circle that **MUST** be drawn with a single thick black line (see Figure 9.2).
- ◆ The use of text, color, size, and lines for an End Event **MUST** follow the rules defined in Section 8.3, “Use of Text, Color, Size, and Lines in a Diagram,” on page 26 with the exception that:
 - ◆ The thickness of the line **MUST** remain thick so that the End Event may be distinguished from the Intermediate and Start Events.



Figure 9.2 - End Event

To continue discussing how flow proceeds throughout the process, an End Event consumes a Token that had been generated from a Start Event within the same level of Process. If parallel Sequence Flow target the End Event, then the Tokens will be consumed as they arrive. All the Tokens that were generated within the Process must be consumed by an End Event before the Process has been completed. In other circumstances, if the Process is a Sub-Process, it can be stopped prior to normal completion through exception Intermediate Events (See Section 10.2.2, “Exception Flow,” on page 130 for more details). In this situation the Tokens will be consumed by an Intermediate Event attached to the boundary of the Sub-Process.

Semantics of the End Event include:

- ◆ There **MAY** be multiple End Events within a single level of a process.
- ◆ This shape is **OPTIONAL**: a given Process level—a top-level Process or an expanded Sub-Process—**MAY** (is not required to) have this shape:
 - ◆ If there is a Start Event, then there **MUST** be at least one End Event.
 - ◆ If an End Event is used, then there **MUST NOT** be other flow elements that do not have any outgoing Sequence Flow—all other Flow Objects **MUST** be a source of at least one Sequence Flow.
 - ◆ Exceptions to this are activities that are defined as being Compensation activities (have the Compensation Marker). Compensation Activities **MUST NOT** have any outgoing Sequence Flow, even if there is an End Event in the Process level. Section 10.3, “Compensation Association,” on page 133 for more information on Compensation activities.
 - ◆ If the End Event is not used, then all Flow Objects that do not have any outgoing Sequence Flow (i.e., are not a source of a Sequence Flow) mark the end of a path in the Process. However, the process **MUST NOT** end until all parallel paths have completed.
 - ◆ Exceptions to this are activities that are defined as being Compensation activities (have the Compensation Marker). Compensation Activities are not considered a part of the Normal Flow and **MUST NOT** mark the end of the Process.

Note – A BPD may have more than one Process level (i.e., it can include Expanded Sub-Processes). The use of Start and End Events is independent for each level of the Diagram.









For Processes without an End Event, a Token entering a path-ending Flow Object will be consumed when the processing performed by the object is completed (i.e., when the path has completed), as if the Token had then gone on to reach an End Event. When all Tokens for a given instance of the Process are consumed, then the Process will reach a state of being completed.

End Event Results

A BPMN modeler can define the consequence of reaching an End Event. This will be referred to as the End Event Result.

Table 9.6 displays the types of Results and the graphical marker that will be used for each:

Table 9.6 - End Event Types

| Result | Description | Marker |
|--------------|--|---|
| None | The modeler does not display the type of Event. It is also used to show the end of a Sub-Process that ends, which causes the flow goes back to its Parent Process. |  |
| Message | This type of End indicates that a message is sent to a participant at the conclusion of the Process. |  |
| Error | This type of End indicates that a named Error should be generated. This Error will be caught by an Intermediate Event within the Event Context. |  |
| Cancel | This type of End is used within a Transaction Sub-Process. It will indicate that the Transaction should be cancelled and will trigger a Cancel Intermediate Event attached to the Sub-Process boundary. In addition, it will indicate that a Transaction Protocol Cancel message should be sent to any Entities involved in the Transaction. |  |
| Compensation | This type of End will indicate that a Compensation is necessary. The Compensation identifier will trigger an Intermediate Event when the Process is rolling back. |  |
| Link | A Link is a mechanism for connecting the end (Result) of one Process to the start (Trigger) of another. Typically, these are two Sub-Processes within the same parent Process. A Token arriving at Link End Event will immediately jump to its corresponding target Start or Intermediate Event. |  |
| Terminate | This type of End indicates that all activities in the Process should be immediately ended. This includes all instances of Multi-Instances. The Process is ended without compensation or event handling. |  |
| Multiple | This means that there are multiple consequences of ending the Process. All of them will occur (e.g., there might be multiple messages sent). The attributes of the End Event will define which of the other types of Results apply. |  |

Attributes

The following table displays the set of attributes of an End Event, which extends the set of common Event attributes (see Table 9.3):

Table 9.7 - End Event Attributes

| Attributes | Description |
|--|---|
| Result (None Message Error Cancel Compensation Link Terminate Multiple) None : String | Result is an attribute (default None) that defines the type of result expected for that End. The Cancel Result MUST NOT be used unless the Event is used within a Process that is a Transaction. The Result list MAY be extended to include new types. These new Results MAY have a new modeler- or tool-defined Marker to fit within the boundaries of the Event. |
| [Message Result only] Message : Message | If the Result is a Message, then the Message MUST be supplied. The attributes of a Message can be found in Section B.11.4, “Message,” on page 269. |
| [Message Result only] Implementation (Web Service Other Unspecified) Web Service : String | This attribute specifies the technology that will be used to send the message. A Web service is the default technology. |
| [Error Result only] ErrorCode : String | If the Result is an Error, then the ErrorCode MUST be supplied. |
| [Compensation Result only] Activity : Object | If the Result is a Compensation, then the Object of the Activity that needs to be compensated MUST be supplied. |
| [Link Result only] LinkId : String | If the Result is a Link, then the LinkId MUST be entered. |
| [Link Result only] ProcessRef : Process | If the Result is a Link, then the ProcessRef MUST be entered. The identified Process MAY be the same Process as that of the Link Event. |
| [Multiple Result only] Results (2-n) : Result | If the Result attribute is a Multiple, then a list of two or more Results MUST be entered. Each Result on the list MUST have the appropriate data as specified for the above attributes. The Result MUST NOT be of type None, Terminate, or Multiple. |

Sequence Flow Connections

Section 8.4.1, “Sequence Flow Rules,” on page 27 for the entire set of objects and how they may be source or targets of Sequence Flow.

- ◆ An End Event **MUST** be a target for Sequence Flow.
- ◆ An End Event **MAY** have multiple incoming Sequence Flow.

The Flow **MAY** come from either alternative or parallel paths. For modeling convenience, each path **MAY** connect to a separate End Event object. The End Event is used as a Sink for all Tokens that arrive at the Event. All Tokens that are generated at the Start Event for that Process must eventually arrive at an End Event. The Process will be in a *running* state until all Tokens are consumed.

- ◆ An End Event **MUST NOT** be a source for Sequence Flow; that is, there **MUST NOT** be outgoing Sequence Flow.
- ◆ An exception to this is when an End Event is used in an Expanded Sub-Process and is attached to the boundary of that Sub-Process. In this case, a Sequence Flow from the higher-level Process **MAY** connect from that End Event in lieu of connecting from the actual boundary of the Sub-Process (see Figure 10.16).

Message Flow Connections

See Section 8.4.2, “Message Flow Rules,” on page 28 for the entire set of objects and how they may be source or targets of Message Flow.

Note – All Message Flow must connect two separate Pools. They can connect to the Pool boundary or to Flow Objects within the Pool boundary. They cannot connect two objects within the same Pool.

- ◆ An End Event **MUST NOT** be the target for Message Flow; it can have no incoming Message Flow.
- ◆ An End Event **MAY** be a source for Message Flow; it can have one or more outgoing Message Flow.

Changes Since 1.0 Draft Version

These are the changes since the last publicly released version:

- The constraint about the fill of the Event was removed.
- The definition of the Link End Event was updated to include a description of Token flow.
- The attribute table was reorganized to make it more clear that some attributes applied only if the Result attribute was set to specific values.
- For the Result attribute, within the set of End Event attributes, the type Rule was removed from the list of types of Results. It should not have been listed there initially.
- The Exception Results was renamed to Error.
- The Message attribute, within the set of the End Event attributes, was changed to be of type Message.
- For a Result of type Compensation. the attributes were rather vaguely defined and have been consolidated to be a single attribute named Activity of type Object.
- The LinkName attribute, within the set of the End Event attributes, renamed to LinkId was changed to be of type String.
- The Implementation and ProcessRef attributes were added to the list of End Event attributes.
- The cardinality of the list of Results for the Multiple Result was modified so that it is now 2 or more.

9.3.4 Intermediate

Intermediate Events occur between a Start Event and an End Event. This is an event that occurs after a Process has been started. It will affect the flow of the process, but will not start or (directly) terminate the process. Intermediate Events can be used to:

- Show where messages are expected or sent within the Process,
- Show delays are expected within the Process,

- Disrupt the Normal Flow through exception handling, or
- Show the extra work required for compensation.

The Intermediate Event shares the same basic shape of the Start Event and End Event, a circle with an open center so that markers can be placed within the circle to indicate variations of the Event.

- ◆ An Intermediate Event is a circle that **MUST** be drawn with a double thin black line. (see Figure 9.3).
- ◆ The use of text, color, size, and lines for an Intermediate Event **MUST** follow the rules defined in Section 8.3, “Use of Text, Color, Size, and Lines in a Diagram,” on page 26 with the exception that:
 - ◆ The thickness of the line **MUST** remain double so that the Intermediate Event may be distinguished from the Start and End Events.



Figure 9.3 - Intermediate Event

One use of Intermediate Events is to represent exception or compensation handling. This will be shown by placing the Intermediate Event on the boundary of a Task or Sub-Process (either collapsed or expanded). Figure 9.4 displays an example of an Intermediate Event attached to a Task. The Intermediate Event can be attached to any location of the activity boundary and the outgoing Sequence Flow can flow in any direction. However, in the interest of clarity of the Diagram, we recommend that the modeler choose a consistent location on the boundary. For example, if the Diagram orientation is horizontal, then the Intermediate Events can be attached to the bottom of the activity and the Sequence Flow directed down, then to the right. If the Diagram orientation is vertical, then the Intermediate Events can be attached to the left or right side of the activity and the Sequence Flow directed to the left or right, then down.

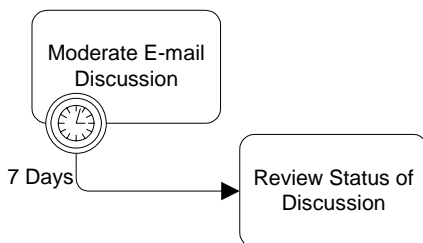











Figure 9.4 - Task with an Intermediate Event attached to its boundary

Intermediate Event Triggers

There are eight types of Intermediate Events in BPMN: Message, Timer, Error, Compensation, Cancel, Rule, Link, and Multiple. These Event types indicate the different ways that a Process may be interrupted or delayed after it has started. Each type of Intermediate Event will have a different icon placed in the center of the Intermediate Event shape to distinguish one from another.

Table 9.8 displays the types of Triggers and the graphical marker that will be used for each:

Table 9.8 - Intermediate Event Types

| Trigger | Description | Marker |
|--------------|--|---|
| None | This is valid for only Intermediate Events that are in the main flow of the Process. The modeler does not display the type of Event. It is used for modeling methodologies that use Events to indicate some change of state in the Process. |  |
| Message | A message arrives from a participant and triggers the Event. This causes the Process to continue if it was waiting for the message, or changes the flow for exception handling. In Normal Flow, Message Intermediate Events can be used for sending messages to a participant. If used for exception handling it will change the Normal Flow into an Exception Flow. |  |
| Timer | A specific time-date or a specific cycle (e.g., every Monday at 9am) can be set that will trigger the Event. If used within the main flow it acts as a delay mechanism. If used for exception handling it will change the Normal Flow into an Exception Flow. |  |
| Error | This is used for error handling--both to set (throw) and to react to (catch) errors. It sets (throws) an error if the Event is part of a Normal Flow. It reacts to (catches) a named error, or to any error if a name is not specified, when attached to the boundary of an activity. |  |
| Cancel | This type of Intermediate Event is used within a Transaction Sub-Process. This type of Event MUST be attached to the boundary of a Sub-Process. It SHALL be triggered if a Cancel End Event is reached within the Transaction Sub-Process. It also SHALL be triggered if a Transaction Protocol “Cancel” message has been received while the Transaction is being performed. |  |
| Compensation | This is used for compensation handling--both setting and performing compensation. It call for compensation if the Event is part of a Normal Flow. It reacts to a named compensation call when attached to the boundary of an activity. |  |
| Rule | This is only used for exception handling. This type of event is triggered when a Rule becomes true. A Rule is an expression that evaluates some Process data. |  |
| Link | A Link is a mechanism for connecting an End Event (Result) of one Process to an Intermediate Event (Trigger) in another Process. Paired Intermediate Events can also be used as “Go To” objects within a Process. |  |
| Multiple | This means that there are multiple ways of triggering the Event. Only one of them will be required. The attributes of the Intermediate Event will define which of the other types of Triggers apply. |  |

Attributes

The following table displays the set of attributes of an Intermediate Event, which extends the set of common Event attributes (see Table 9.9):

Table 9.9 - Intermediate Event Attributes

| Attributes | Description |
|--|--|
| Trigger (None Message Timer Error Cancel Link Compensation Rule Multiple) Message : String | Trigger is an attribute (default Message) that defines the type of trigger expected for that Intermediate Event. The None and Link Trigger MUST NOT be used when the Event is attached to the boundary of an Activity. The Multiple, Rule, and Cancel Triggers MUST NOT be used when the Event is part of the Normal Flow of the Process. The Cancel Trigger MUST NOT be used when the Event is attached to the boundary of a Transaction or if the Event is not contained within a Process that is a Transaction. The Trigger list MAY be extended to include new types. These new Triggers MAY have a new modeler- or tool-defined Marker to fit within the boundaries of the Event. |
| Target (0-1) : Object | A Target MAY be included for the Intermediate Event. The Target MUST be an activity (Sub-Process or Task). This means that the Intermediate Event is attached to the boundary of the activity and is used to signify an exception or compensation for that activity. |
| [Message Trigger only] Message : Message | If the Trigger is a Message, then the Message MUST be supplied. The attributes of a Message can be found in Section B.11.4, “Message,” on page 269. |
| [Message Trigger only] Implementation (Web Service Other Unspecified) Web Service | This attribute specifies the technology that will be used to send or receive the message. A Web service is the default technology. |
| [Timer Trigger only] TimeDate (0-1) : Date | If the Trigger is a Timer, then a TimeDate MAY be entered. If a TimeDate is not entered, then a TimeCycle MUST be entered (see the attribute below). |
| [Timer Trigger only] TimeCycle (0-1) : String | If the Trigger is a Timer, then a TimeCycle MAY be entered. If a TimeCycle is not entered, then a TimeDate MUST be entered (see the attribute above). |
| [Error Trigger only] ErrorCode : String | For an Intermediate Event within Normal Flow: If the Trigger is an Error, then the ErrorCode MUST be entered. This “throws” the error. For an Intermediate Event attached to the boundary of an Activity: If the Trigger is an Error, then the error code MAY be entered. This Event “catches” the error. If there is no error code, then any Error SHALL trigger the Event. If there is an error code, then only an Error that matches the error code SHALL trigger the Event. |

Table 9.9 - Intermediate Event Attributes

| Attributes | Description |
|--|--|
| [Compensation Trigger only] Activity : Object | For an Intermediate Event within Normal Flow: If the Trigger is a Compensation, then the Object of the Activity that needs to be compensated MUST be supplied. This “throws” the compensation. For an Intermediate Event attached to the boundary of an Activity: This Event “catches” the compensation. No further information is required. The Object of the activity the Event is attached to will provide the Id necessary to match the compensation event with the event that “threw” the compensation. |
| [Rule Trigger only] RuleName : Rule | If the Trigger is a Rule, then a Rule MUST be entered. The attributes of a Rule can be found in Section B.11.9, “Rule,” on page 271. |
| [Link Trigger only] LinkId : String | If the Trigger is a Link, then the LinkId MUST be supplied. |
| [Link Trigger only] ProcessRef : Process | If the Trigger is a Link, then the ProcessRef MUST be entered. The identified Process MAY be the same Process as that of the Link Event. |
| [Multiple Trigger only] Triggers (2-n) : Trigger | If the Trigger is a Multiple, then each Trigger on the list MUST have the appropriate data as specified for the above attributes. The Trigger MUST NOT be of type None or Multiple. |

Activity Boundary Connections

An Intermediate Event can be attached to the boundary of an activity under the following conditions:

- ◆ (One or more) Intermediate Events **MAY** be attached directly to the boundary of an Activity.
 - ◆ To be attached to the boundary of an Activity, an Intermediate Event **MUST** be one of the following Triggers: Message, Timer, Error, Cancel, Compensation, Rule, and Multiple.
 - ◆ An Intermediate Event with a Cancel Trigger **MAY** be attached to a Sub-Process boundary only if the Transaction attribute of the Sub-Process is set to **TRUE**.

Sequence Flow Connections

See Section 8.4.1, “Sequence Flow Rules,” on page 27 for the entire set of objects and how they may be source or targets of Sequence Flow.

- ◆ The following Intermediate Events **MAY** be attached to the boundary of an Activity: Message, Timer, Exception, Cancel (only Sub-Process that is a Transaction), Compensation, Rule, and Multiple. Thus, the following **MUST NOT**: None, and Link.
 - ◆ If the Intermediate Event is attached to the boundary of an activity:
 - ◆ The Intermediate Event **MUST NOT** be a target for Sequence Flow; it cannot have an incoming Flow.
 - ◆ The Intermediate Event **MUST** be a source for Sequence Flow; it can have one (and only one) outgoing Sequence Flow.
 - ◆ An exception to this: an Intermediate Event with a Compensation Trigger **MUST NOT** have an outgoing Sequence Flow (it **MAY** have an outgoing Association).
- ◆ The following Intermediate Events **MAY** be used in Normal Flow: None, Message, Timer, Exception, Compensation, Rule, and Link. Thus, the following **MUST NOT**: Cancel, and Multiple.

- ◆ If the Intermediate Event is used within Normal Flow:
 - ◆ Intermediate Events of the following types **MUST** be a target of a Sequence Flow: None, Error, and Compensation. It **MUST** have one (and only one) incoming Flow.
 - ◆ Intermediate Events of the following types **MAY** be a target of a Sequence Flow: Message, Timer, Rule, and Link. It **MAY** have one (and only one) incoming Flow.

Note – These types of Intermediate Events will always be ready to accept the Event Triggers while the Process in which they are contained is active.

- ◆ An Intermediate Event **MUST** be a source for Sequence Flow; it **MUST** have one (and only one) outgoing Sequence Flow.
 - ◆ An exception to this: an Source Link Intermediate Event (as defined below), it is not required to have an outgoing Sequence Flow.
- ◆ An Intermediate Event with a Link Trigger **MUST NOT** be both a target and a source of a Sequence Flow unless it is part of an Event-Based Exclusive Gateway.

To define the use of a Link Intermediate Event as an “Off-Page Connector” or a “Go To” object:

- ◆ A Link Intermediate Event **MAY** be the target (Target Link) or a source (Source Link) of a Sequence Flow, but **MUST NOT** be both a target and a source.
 - ◆ If there is a Source Link, there **MUST** be a matching Target Link (they have the same LinkId). Note: A Source Link (Intermediate Event) should not be used for linking with another Process within the same Pool; an End Event should be used for this purpose.
 - ◆ There **MAY** be multiple Source Links for a single Target Link.
 - ◆ There **MUST NOT** be multiple Target Links for a single Source Link.
 - ◆ A Target Link **MAY** be used without a corresponding Source Link. This indicates that the Source Link (an End Event) exists in another Process within the same Pool.

Message Flow Connections

See Section 8.4.2, “Message Flow Rules,” on page 28 for the entire set of objects and how they may be source or targets of Message Flow.

Note – All Message Flow must connect two separate Pools. They can connect to the Pool boundary or to Flow Objects within the Pool boundary. They cannot connect two objects within the same Pool.

- ◆ An Intermediate Event of type Message **MAY** be the target for Message Flow; it can have one incoming Message Flow.
- ◆ An Intermediate Event **MUST NOT** be a source for Message Flow; it can have no outgoing Message Flow.

Changes Since 1.0 Draft Version

These are the changes since the last publicly released version:

- The Activity Boundary connections details were added.
- The Normal Flow Sequence Flow connections details were updated.
- The constraint about the fill of the Event was removed.

- The definition of Link Intermediate Events was expanded to describe behavior as “Go To” objects within a Process.
- The attribute table was reorganized to make it more clear that some attributes applied only if the Trigger attribute was set to specific values.
- The Target attribute was added to the set of Intermediate Event attributes.
- The Message attribute, within the set of the Intermediate Event attributes, was changed to be of type Message.
- The attribute for a Timer Event, within the set of the Intermediate Event attributes, was divided into two separate attributes. One is TimeDate and the other is TimeCycle.
- The Exception Trigger was renamed to Error.
- The definition of Error setting of the Trigger attribute of the set of Intermediate attributes was updated. The update provided a separation for the uses of the Event either within Normal Flow or attached to the boundary of an activity. Also, the attribute ErrorCode was renamed ErrorName and its type was changed to String.
- The definition of Compensation setting of the Trigger attribute of the set of Intermediate attributes was updated. The update provided a separation for the uses of the Event either within Normal Flow or attached to the boundary of an activity. Also, the term ActivityId was changed to Object.
- The RuleExpression attribute, within the set of the Intermediate Event attributes, was renamed to RuleName and was changed to be of type Rule.
- The LinkName attribute, within the set of the Intermediate Event attributes, was renamed toLinkId and was changed to be of type String.
- The Implementation and ProcessRef attributes were added to the list of Intermediate Event attributes.
- The cardinality of the list of Triggers for the Multiple Trigger was modified so that it is now 2 or more.

9.4 Activities

An activity is work that is performed within a business process. An activity can be atomic or non-atomic (compound). The types of activities that are a part of a Business Process Diagram are: Process, Sub-Process, and Task. However, a Process is not a specific graphical object. Instead, it is a set of graphical objects. The following sections will focus on the graphical objects Sub-Process and Task. More information about Processes can be found in Section 8.6, “Processes,” on page 29.

9.4.1 Common Activity Attributes

The following table displays the set of attributes common to both a Sub-Process and a Task, and which extends the set of common Flow Object attributes (see Table 9.3) -- Note that Table 9.11 and Table 9.12 contain additional attributes that must be included within this set if extended by any other attribute table:

Table 9.10 - Common Activity Attributes

| Attributes | Description |
|--|---|
| ActivityType (Task Sub-Process) Task : String | The ActivityType MUST be of type Task or Sub-Process. |

Table 9.10 - Common Activity Attributes

| Attributes | Description |
|---|---|
| Status (None Ready Active Cancelled Aborting Aborted Completing Completed) None : String | The Status of an activity is determined when the activity is being executed by a process engine. The Status of an activity can be used within Assignment Expressions. |
| Properties (0-n) : Property | Modeler-defined Properties MAY be added to an activity. These Properties are “local” to the activity. These Properties are only for use within the processing of the activity. The fully delineated name of these properties is “<process name>.<activity name>.<property name>” (e.g., “Add Customer.Review Credit.Status”). Further details about the definition of a Property can be found in Section B.11.7, “Property,” on page 270. |
| InputSets (0-n) : Input | The InputSets attribute defines the data requirements for input to the activity. Zero or more InputSets MAY be defined. Each InputSet is sufficient to allow the activity to be performed (if it has first been instantiated by the appropriate signal arriving from an incoming Sequence Flow). |
| [Input: for InputSets only] Inputs (1-n) : Artifact | One or more Inputs MUST be defined for each InputSet. An Input is an Artifact, usually a Document Object. Note that the Artifacts MAY also be displayed on the diagram and MAY be connected to the activity through an Association--however, it is not required for them to be displayed. |
| OutputSets (0-n) : Output | The OutputSets attribute defines the data requirements for output from the activity. Zero or more OutputSets MAY be defined. At the completion of the activity, only one of the OutputSets may be produced--It is up to the implementation of the activity to determine which set will be produced. However, the IORules attribute MAY indicate a relationship between an OutputSet and an InputSet that started the activity. |
| [Output: for OutputSets only] Outputs (1-n) : Artifact | One or more Outputs MUST be defined for each OutputSet. An Output is an Artifact, usually a Document Object. Note that the Artifacts MAY also be displayed on the diagram and MAY be connected to the activity through an Association--however, it is not required for them to be displayed. |
| IORules (0-n) : Expression | The IORules attribute is an expression that defines the relationship between one InputSet and one OutputSet. That is, if the activity is instantiated with a specified InputSet, then the output of the activity MUST produce the specified OutputSet. Zero or more IORules may be entered. |
| StartQuantity 1 : Integer | The default value is 1. The value MUST NOT be less than 1. This attribute defines the number of Tokens that must arrive from a single Sequence Flow before the activity can begin. |
| LoopType (None Standard MultiInstance) None : String | LoopType is an attribute and is by default None, but MAY be set to Standard or MultiInstance. If so, the Loop marker SHALL be placed at the bottom center of the activity shape (see Figure 9.8 and Figure 9.13). A Task of type Receive that has its Instantiate attribute set to True MUST NOT have a Standard or MultiInstance LoopType. |

Standard Loop Attributes

A Standard Loop activity will have a boolean expression that is evaluated after each cycle of the loop. If the expression is still True, then the loop will continue. There are two variations of the loop, which reflect the programming constructs of while and until. That is, a while loop will evaluate the expression before the activity is performed, which means that the activity may not actually be performed. The until loop will evaluate the expression after the activity has been performed, which means that the activity will be performed at least once.

The following are additional attributes of a Standard Loop Activity (where the LoopType attribute is set to “Standard”), which extends the set of common activity attributes (see Table 9.10):

Table 9.11 - Standard Loop Activity Attributes

| Attributes | Description |
|---|--|
| LoopCondition : Expression | Standard Loops MUST have a boolean Expression to be evaluated, plus the timing when the expression SHALL be evaluated. The attributes of an Expression can be found in Section B.11.3, “Expression,” on page 269. |
| LoopCounter : Integer | The LoopCounter attribute is used at runtime to count the number of loops and is automatically updated by the process engine. The LoopCounter attribute MUST be incremented at the start of a loop. The modeler may use the attribute in the LoopCondition Expression. |
| LoopMaximum (0-1) : Integer | The Maximum an optional attribute that provides is a simple way to add a cap to the number of loops. This SHALL be added to the Expression defined in the LoopCondition. |
| TestTime (Before After) After : String | The expressions that are evaluated Before the activity begins are equivalent to a programming while function. The expression that are evaluated After the activity finishes are equivalent to a programming until function. |

Multi-Instance Loop Attributes

Multi-Instance loops reflect the programming construct for each. The loop expression for a Multi-Instance loop is a numeric expression evaluated only once before the activity is performed. The result of the expression evaluation will be an integer that will specify the number of times that the activity will be repeated.

There are also two variations of the Multi-Instance loop where the instances are either performed sequentially or in parallel.

The following are additional attributes of a Multi-Instance Loop Activity (where the LoopType attribute is set to “MultiInstance”), which extends the set of common activity attributes (see Table 9.10):

Table 9.12 - Multi-Instance Loop Activity Attributes

| Attributes | Description |
|----------------------------------|---|
| MI_Condition : Expression | MultiInstance Loops MUST have a numeric Expression to be evaluated--the Expression MUST resolve to an integer. The attributes of an Expression can be found in Section B.11.3, “Expression,” on page 269. |

Table 9.12 - Multi-Instance Loop Activity Attributes

| Attributes | Description |
|--|--|
| LoopCounter : Integer | The LoopCounter attribute is only applied for Sequential MultiInstance Loops and for processes that are being executed by a process engine. The attribute is updated at runtime by a process engine to count the number of loops as they occur. The LoopCounter attribute MUST be incremented at the start of a loop. Unlike a Standard loop, the modeler does not use this attribute in the MI_Condition Expression, but it can be used for tracking the status of a loop. |
| MI_Ordering (Sequential Parallel) Sequential : String | This applies to only MultiInstance Loops. The MI_Ordering attribute defines whether the loop instances will be performed sequentially or in parallel. Sequential MI_Ordering is a more traditional loop. Parallel MI_Ordering is equivalent to multi-instance specifications that other notations, such as UML Activity Diagrams use. If set to Parallel, the Parallel marker SHALL replace the Loop Marker at the bottom center of the activity shape (see Figure 9.8 and Table 9.10). |
| [Parallel MI_Ordering only] MI_FlowCondition (None One All Complex) All : String | This attribute is equivalent to using a Gateway to control the flow past a set of parallel paths. An MI_FlowCondition of “None” is the same as uncontrolled flow (no Gateway) and means that all activity instances SHALL generate a token that will continue when that instance is completed. An MI_FlowCondition of “One” is the same as an Exclusive Gateway and means that the Token SHALL continue past the activity after only one of the activity instances has completed. The activity will continue its other instances, but additional Tokens MUST NOT be passed from the activity. An MI_FlowCondition of “All” is the same as a Parallel Gateway and means that the Token SHALL continue past the activity after all of the activity instances have completed. An MI_FlowCondition of “Complex” is the same as a Complex Gateway. The ComplexMI_FlowCondition attribute will determine the Token flow. |
| [Complex MI_FlowCondition only] ComplexMI_FlowCondition (0-1) : Expression | If the MI_FlowCondition attribute is set to “Complex,” then an Expression Must be entered. This Expression that MAY reference Process data. The expression SHALL determine when and how many Tokens will continue past the activity. The attributes of an Expression can be found in the Section B.11.3, “Expression,” on page 269. |

Changes Since 1.0 Draft Version

These are the changes since the last publicly released version:

- This set of attributes was removed from each of the set of Sub-Process attributes (Table 9.13) and Task attributes (Table 9.17) and moved to the above table (Table 9.12).
 - Within the set of common activity attributes, the attributes for standard activity loops and for multi-instance activity loops were each placed into separate tables (Table 9.11 and Table 9.12, respectively).
 - The ActivityType attribute was added to the set of common activity attributes.

- The Name and Type attributes were removed from the set of common activity attributes. These attributes can be found in the definition of a Property, which can be found in the Section B.11.7, “Property,” on page 270.
- The InputSets attribute was added to the set of common activity attributes.
- The Inputs attribute was included in the set of common activity attributes, which means that it also applies to Sub-Processes. This attribute was redefined to be a list of Artifacts and to be dependent on the InputSets attribute.
- The OutputSets attribute was added to the set of common activity attributes.
- The Outputs attribute was included in the set of common activity attributes, which means that it also applies to Sub-Processes. This attribute was redefined to be a list of Artifacts and to be dependent on the OutputSets attribute.
- The IORules attribute was added to the set of common activity attributes.
- The StartQuantity attribute was added to the set of common activity attributes.
- The specification of the LoopType attribute, within the set of common activity attributes, was updated to note that Receive Tasks that instantiate the Process cannot be a looping activity.
- The Counter attribute, within the set of looping activity attributes, was renamed to LoopCounter and its type was changed to Integer. The description of the attribute was updated to show the difference between its use for Standard and Multi-Instance loops.
- The Maximum attribute, within the set of standard looping activity attributes, was renamed to LoopMaximum and its type was changed to Integer.
- The InstanceGeneration attribute, within the set of Multi-Instance looping activity attributes, was renamed to MI_Ordering.
 - The Serial type for this attribute was renamed to Sequential.
- The LoopFlowCondition attribute, within the set of Multi-Instance looping activity attributes, was renamed to MI_FlowCondition.
 - A None type was added to the types for the MI_FlowCondition attribute. The definitions of the One type and the All type were updated.
- The Complex attribute, within the set of Multi-Instance looping activity attributes, was renamed to ComplexMI_FlowCondition.
- The description of the TestTime attribute, within the set of standard looping activity attributes, was updated to show that a TestTime of After is the same as a programming until function.

9.4.2 Sub-Process

A **Sub-Process** is a compound activity in that it has detail that is defined as a flow of other activities. A Sub-Process is a graphical object within a Process Flow, but it also can be “opened up” to show another Process (either Embedded or Independent). A Sub-Process object shares the same shape as the Task object, which is a rounded rectangle.

- ◆ A Sub-Process is a rounded corner rectangle that **MUST** be drawn with a single thin black line.
 - ◆ The use of text, color, size, and lines for a Sub-Process **MUST** follow the rules defined in Section 8.3, “Use of Text, Color, Size, and Lines in a Diagram,” on page 26 with the exception that.
 - ◆ The boundary drawn with a double line **SHALL** be reserved for Sub-Process that has its IsATransaction attribute set to True.

The Sub-Process can be in a collapsed view that hides its details (see Figure 9.5) or a Sub-Process can be in an expanded view that shows its details within the view of the Process in which it is contained (see Figure 9.6). In the collapsed form, the Sub-Process object uses a marker to distinguish it as a Sub-Process, rather than a Task.

- ◆ The Sub-Process marker **MUST** be a small square with a plus sign (+) inside. The square **MUST** be positioned at the bottom center of the shape.

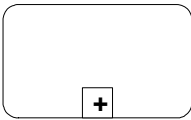

Figure 9.5 - Collapsed Sub-Process

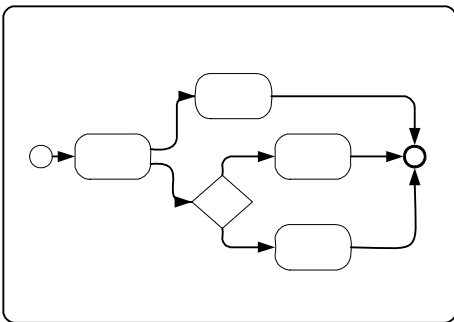

Figure 9.6 - Expanded Sub-Process

Expanded Sub-Process may be used for multiple purposes. They can be used to “flatten” a hierarchical process so that all detail can be shown at the same time. They are used to create a context for exception handling that applies to a group of activities (Section 10.2.2, “Exception Flow,” on page 130 for more details). Compensations can be handled similarly (Section 10.3, “Compensation Association,” on page 133 for more details).

Expanded Sub-Process may be used as a mechanism for showing a group of parallel activities in a less-cluttered, more compact way. In Figure 9.7, activities “C” and “D” are enclosed in an unlabeled Expanded Sub-Process. These two activities will be performed in parallel. Notice that the Expanded Sub-Process does not include a Start Event or an End Event and the Sequence Flow to/from these Events. This usage of Expanded Sub-Processes for “parallel boxes” is the motivation for having Start and End Events being optional objects.

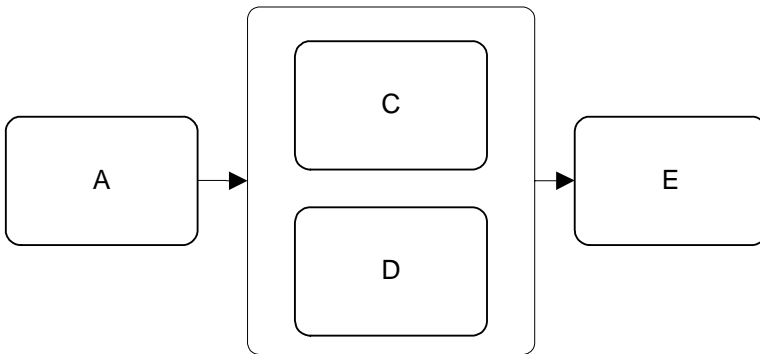

Figure 9.7 - Expanded Sub-Process used as a “parallel box”

BPMN specifies five types of standard markers for Sub-Processes. The (Collapsed) Sub-Process Marker, seen in Figure 9.5, can be combined with four other markers: a Loop Marker or a Parallel Marker, a Compensation Marker, and an Ad Hoc Marker. A collapsed Sub-Process may have one to three of these other markers, in all combinations except that Loop and Multiple Instance cannot be shown at the same time (see Figure 9.8).

- ◆ The marker for a Sub-Process that loops **MUST** be a small line with an arrowhead that curls back upon itself.
 - ◆ The Loop Marker **MAY** be used in combination with any of the other markers except the Multiple Instance Marker.
- ◆ The marker for a Sub-Process that has multiple instances **MUST** be a pair of vertical lines in parallel.
 - ◆ The Multiple Instance Marker **MAY** be used in combination with any of the other markers except the Loop Marker.
- ◆ The marker for a Sub-Process that is Ad Hoc **MUST** be a “tilde” symbol.
 - ◆ The Ad-Hoc Marker **MAY** be used in combination with any of the other markers.
- ◆ The marker for a Sub-Process that is used for compensation **MUST** be a pair of left facing triangles (like a tape player “rewind” button).
 - ◆ The Compensation Marker **MAY** be used in combination with any of the other markers.
- ◆ All the markers that are present **MUST** be grouped and the whole group centered at the bottom of the shape.

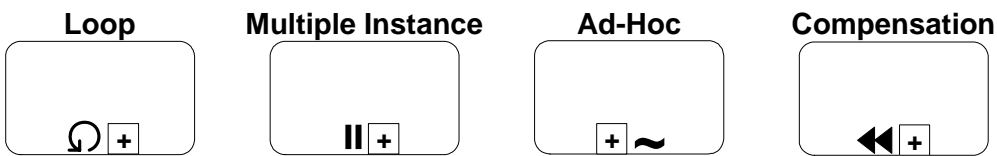

Figure 9.8 - Collapsed Sub-Process Markers

Attributes

The following table displays the set of attributes of a Sub-Process, which extends the set of common activity attributes (see Table 9.13):

Table 9.13 - Sub-Process Attributes

| Attributes | Description |
|---|--|
| SubProcessType (Embedded Independent Reference) Embedded : String | SubProcessType is an attribute that defines whether the Sub-Process details are embedded within the higher level Process or refers to another, re-usable Process. The default is Embedded. |
| IsATransaction False : Boolean | IsATransaction determines whether or not the behavior of the Sub-Process will follow the behavior of a Transaction (see Section , “Sub-Process Behavior as a Transaction,” on page 59). |
| Transaction (0-1) : Transaction | If the Transaction attribute is False, then a Transaction MUST NOT be identified. If the Transaction attribute is True, then a Transaction MUST be identified. The attributes of a Transaction can be found in the Section B.11.10, “Transaction,” on page 271. Note that Transactions that are in different Pools and are connected through Message Flow MUST have the same TransactionId. |

Embedded Sub-Process

An Embedded (or nested) Sub-Process object is an activity that contains other activities (a Process). The Process within the Process is dependent on the parent Process for instigation and has visibility to the parent’s global data. No mapping of data is required.

The objects within the Embedded Sub-Process, being dependent on their parent, do not have all the features of a full Business Process Diagram, such as Pools and Lanes. Thus, an expanded view of the Embedded Sub-Process would only contain Flow Objects, Connecting Objects, and Artifacts (see Figure 9.7).

The following are additional attributes of a Embedded Sub-Process (where the SubProcessType attribute is set to “Embedded”), which extends the set of Sub-Process attributes (see Table 9.14):

Table 9.14 - Embedded Sub-Process Attributes

| Attributes | Description |
|---|---|
| GraphicalElements (0-n) : Object | The GraphicalElements attribute identifies all of the objects (e.g., Events, Activities, Gateways, and Artifacts) that are contained within the Embedded Sub-Process. |
| AdHoc False : Boolean | AdHoc is a boolean attribute, which has a default of False. This specifies whether the Embedded Sub-Process is Ad Hoc or not. The activities within an Ad Hoc Embedded Sub-Process are not controlled or sequenced in a particular order, there performance is determined by the performers of the activities. |
| [AdHoc = True only] AdHocOrdering (0-1) (Sequential Parallel) Parallel : String | If the Embedded Sub-Process is Ad Hoc (the AdHoc attribute is True), then the AdHocOrdering attribute MUST be included. This attribute defines if the activities within the Process can be performed in Parallel or must be performed sequentially. The default setting is Parallel and the setting of Sequential is a restriction on the performance that may be required due to shared resources. |

Table 9.14 - Embedded Sub-Process Attributes

| Attributes | Description |
|--|---|
| [AdHoc = True only] AdHocCompletionCondition (0-1) : Expression | If the Embedded Sub-Process is Ad Hoc (the AdHoc attribute is True), then a Completion Condition MUST be included, which defines the conditions when the Process will end. The Ad Hoc marker SHALL be placed at the bottom center of the Process or the Sub-Process shape for Ad Hoc Processes. |

Independent Sub-Process

An Independent Sub-Process object is an activity within a Process that “calls” to another Process that exists within a BDP (see Figure 9.9). The Process that is called is not dependent on the Independent Sub-Process’ parent Process for instantiation or global data. The called Process will be instantiated when called, but it can be instantiated by other Independent Sub-Process objects (in other diagrams) or by a message from an external source. The Independent Sub-Process object may pass data to/from the called Process.

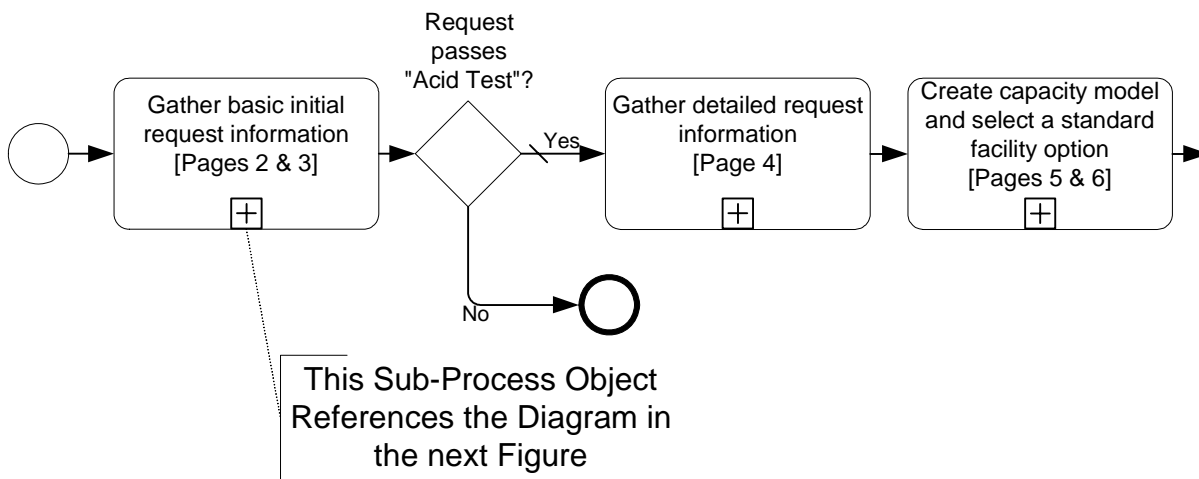

Figure 9.9 - A Sub-Process Object with its Details Shown in the Diagram of the Next Figure

The called Process will exist in a separate diagram that can have multiple Pools. Any view of the called Process (including an expanded view within the calling Process) would show the whole diagram in which the called Process resides (see Figure 9.10), but any data mapping will be only to that Process and not to any of the other Processes that might be in the called diagram.

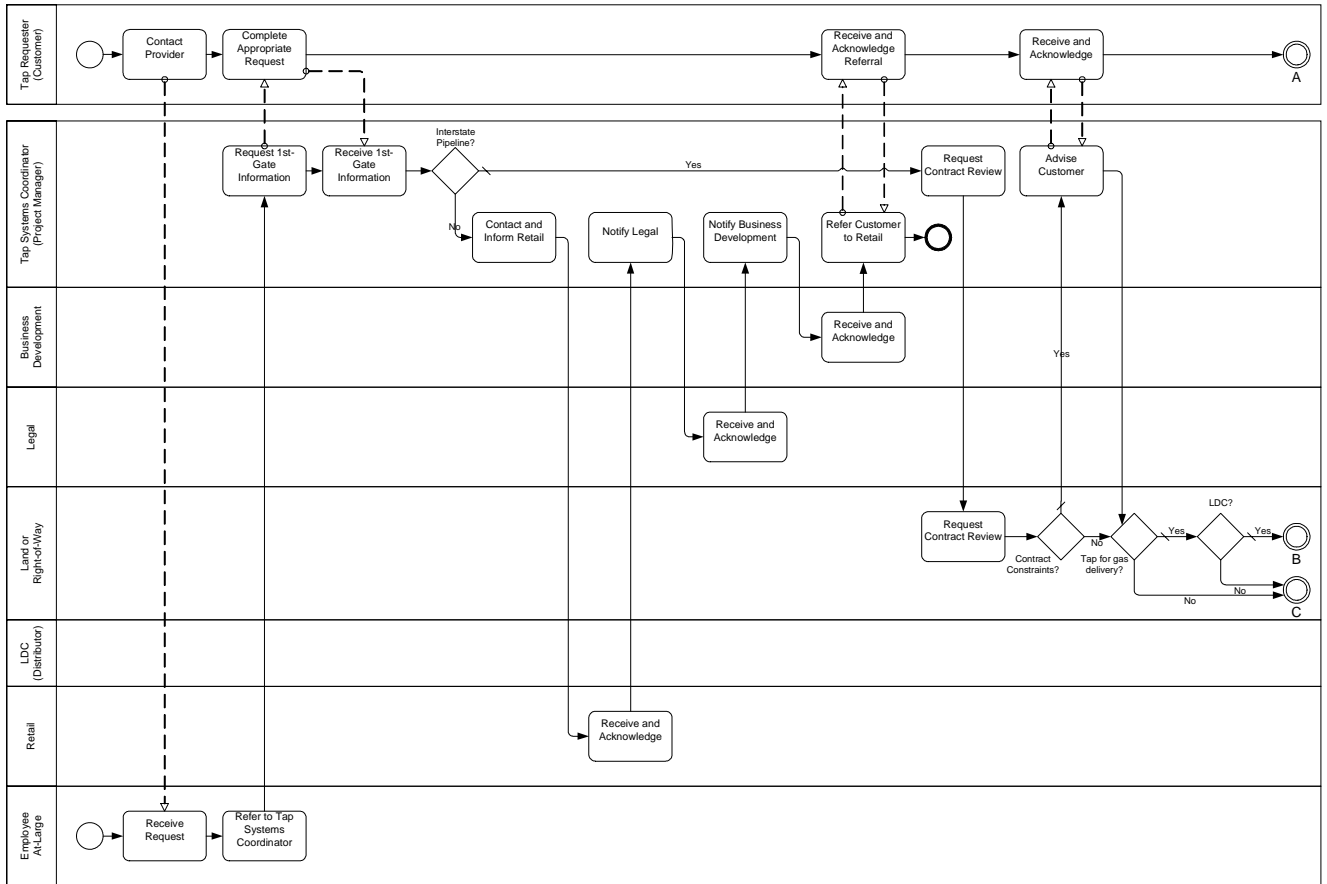

Figure 9.10 - A Process and Diagram Details of the Sub-Process Object in the Previous Figure

The following are additional attributes of a Independent Sub-Process (where the SubProcessType attribute is set to “Independent”), which extends the set of Sub-Process attributes (see Table 9.15):

Table 9.15 - Independent Sub-Process Attributes

| Attributes | Description |
|--|---|
| DiagramRef: Business Process Diagram | The BPD MUST be identified. The attributes of a BPD can be found in the Section 8.5, “Business Process Diagram Attributes,” on page 28. |
| ProcessRef: Process | A Process MUST be identified. The attributes of a Process can be found in the Section 8.6, “Processes,” on page 29. |
| InputPropertyMaps (0-n) : Expression | Multiple input mappings MAY be made between properties of the Independent Sub-Process and the properties of the Process referenced by this object. These mappings are in the form of an expression (although a modeling tool can present this to a modeler in any number of ways). |
| OutputPropertyMaps (0-n) : Expression | Multiple output mappings MAY be made between properties of the Independent Sub-Process and the properties of the Process referenced by this object. These mappings are in the form of an expression (although a modeling tool can present this to a modeler in any number of ways). |

Reference Sub-Process

There may be times where a modeler may want to reference another Sub-Process that has been defined. If the two Sub-Processes share the exact same behavior and properties, then by one referencing the other, the attributes that define the behavior only have to be created once and maintained in only one location.

The following table displays the set of attributes of a Reference Sub-Process (where the SubProcessType attribute is set to “Reference”), which extends the set of Sub-Process attributes (see Table 9.16):

Table 9.16 - Reference Sub-Process Attributes

| Attributes | Description |
|-----------------------------|--|
| SubProcessRef : Task | The Sub-Process being referenced MUST be identified. The attributes for the Sub-Process element can be found in Table 9.13. |

Sub-Process Behavior as a Transaction

A Sub-Process, either collapsed or expanded, can be set as being a Transaction, which will have a special behavior that is controlled through a transaction protocol (such as BTP or WS-Transaction). The boundary of the activity will be double-lined to indicate that it is a Transaction (see Figure 9.11).

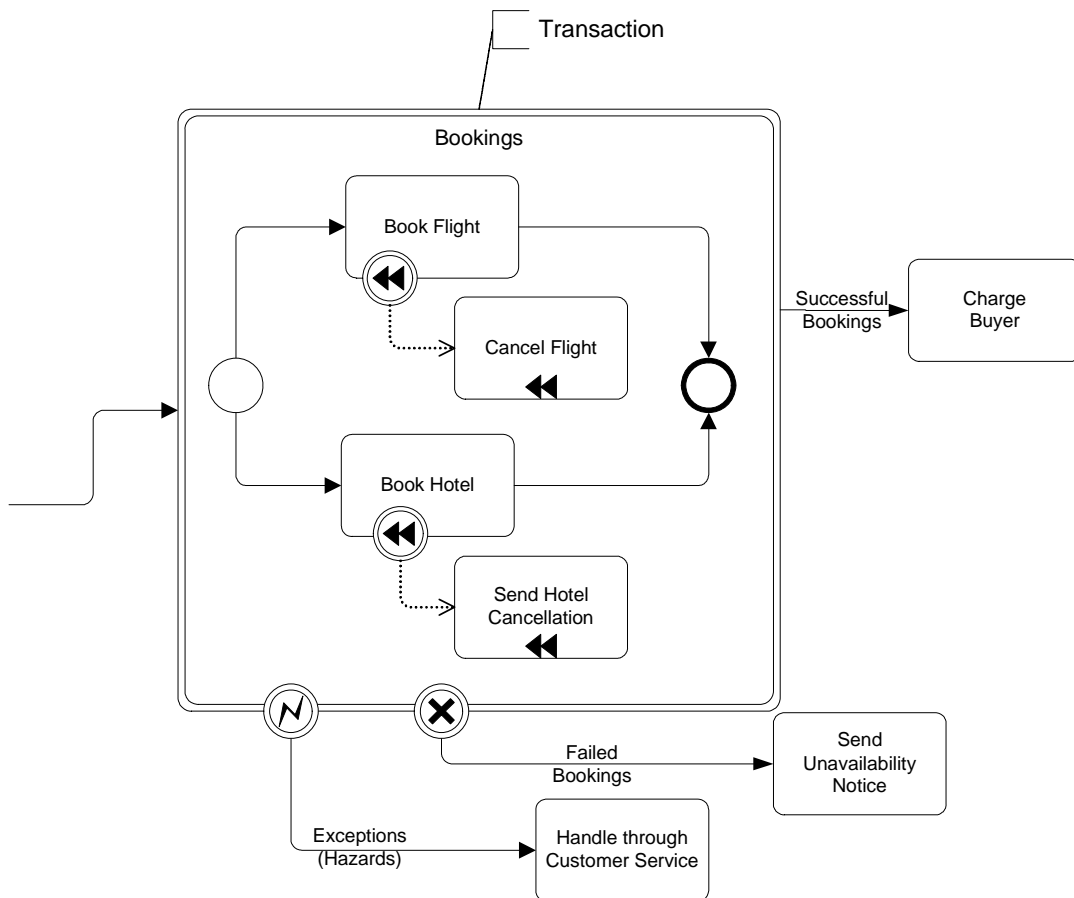

Figure 9.11 - An Example of a Transaction Expanded Sub-Process

There are three basic outcomes of a Transaction:

- **Successful completion:** this will be shown as a normal Sequence Flow that leaves the Sub-Process.
- **Failed completion (Cancel):** When a Transaction is cancelled, then the activities inside the Transaction will be subjected to the cancellation actions, which could include rolling back the process and compensation for specific activities. Note that other mechanisms for interrupting a Sub-Process will not cause Compensation (e.g., Error, Timer, and anything for a non-Transaction activity). A Cancel Intermediate Event, attached to the boundary of the activity, will direct the flow after the Transaction has been rolled back and all compensation has been completed. The Cancel Intermediate Event can only be used when attached to the boundary of a Transaction activity. It cannot be used in any Normal Flow and cannot be attached to a non-Transaction activity. There are two mechanisms that can signal the cancellation of a Transaction:
 - A Cancel End Event is reached within the Transaction Sub-Process. A Cancel End Event can only be used within a Sub-Process that is set to a Transaction.
 - A Cancel Message can be received via the Transaction Protocol that is supporting the execution of the Sub-Process.
- **Hazard:** This means that something went terribly wrong and that a normal success or cancel is not possible. We are using an Error to show Hazards. When a Hazard happens, the activity is interrupted (without Compensation) and the

flow will continue from the Error Intermediate Event.

The behavior at the end of a successful Transaction Sub-Process is slightly different than that of a normal Sub-Process. When each path of the Transaction Sub-Process reaches a non-Cancel End Event(s), the flow does not immediately move back up to the higher-level Parent Process, as does a normal Sub-Process. First, the transaction protocol must verify that all the participants have successfully completed their end of the Transaction. Most of the time this will be true and the flow will then move up to the higher-level Process. But it is possible that one of the participants may end up with a problem that causes a Cancel or a Hazard. In this case, the flow will then move to the appropriate Intermediate Event, even though it had apparently finished successfully.

Note – The exact behavior and notation for defining Transactions is still an Open Issue. Refer Annex D for a complete list of the issues open for BPMN.

Sequence Flow Connections

See Section 8.4.1, “Sequence Flow Rules,” on page 27 for the entire set of objects and how they may be source or targets of Sequence Flow.

- ◆ A Sub-Process MAY be a target for Sequence Flow; it can have multiple incoming Flow. Incoming Flow MAY be from an alternative path and/or a parallel paths.

Note – If the Sub-Process has multiple incoming Sequence Flow, then this is considered uncontrolled flow. This means that when a Token arrives from one of the Paths, the Sub-Process will be instantiated. It will not wait for the arrival of Tokens from the other paths. If another Token arrives from the same path or another path, then a separate instance of the Sub-Process will be created. If the flow needs to be controlled, then the flow should converge on a Gateway that precedes the Sub-Process (Section 9.5, “Gateways,” on page 68 for more information on Gateways).

- ◆ If the Sub-Process does not have an incoming Sequence Flow, and there is no Start Event for the Process, then the Sub-Process MUST be instantiated when the process is instantiated.
 - ◆ Exceptions to this are Sub-Processes that are defined as being Compensation activities (have the Compensation Marker). Compensation Sub-Processes are not considered a part of the Normal Flow and MUST NOT be instantiated when the Process is instantiated.
- ◆ A Sub-Process MAY be a source for Sequence Flow; it can have multiple outgoing Flow. If there are multiple outgoing Sequence Flow, then this means that a separate parallel path is being created for each Flow.

Tokens will be generated for each outgoing Sequence Flow from Sub-Process. The TokenIds for each of the Tokens will be set such that it can be identified that the Tokens are all from the same parallel Fork (AND-Split) as well as the number of Tokens that exist in parallel.

- ◆ If the Sub-Process does not have an outgoing Sequence Flow, and there is no End Event for the Process, then the Sub-Process marks the end of one or more paths in the Process. When the Sub-Process ends and there are no other parallel paths active, then the Process MUST be completed.
 - ◆ Exceptions to this are Sub-Processes that are defined as being Compensation activities (have the Compensation Marker). Compensation Sub-Processes are not considered a part of the Normal Flow and MUST NOT mark the end of the Process.

Message Flow Connections

Section 8.4.2, “Message Flow Rules,” on page 28 for the entire set of objects and how they may be source or targets of Message Flow.

Note – All Message Flow must connect two separate Pools. They can connect to the Pool boundary or to Flow Objects within the Pool boundary. They cannot connect two objects within the same Pool.

- ◆ A Sub-Process MAY be the target for Message Flow; it can have zero or more incoming Message Flow.
- ◆ A Sub-Process MAY be a source for Message Flow; it can have zero or more outgoing Message Flow.

Changes Since 1.0 Draft Version

These are the changes since the last publicly released version:

- The Reference Sub-Process type was added.
- The constraint about the fill of the Sub-Process was removed.
- Attributes that are specific to a Sub-Process of type Embedded a were added and presented in a new table (Table 9.14).
- The set of attributes that are specific to a Sub-Process of type Independent were removed from the main table (Table 9.13) and placed in a separate table (Table 9.15).
- Attributes that are specific to a Sub-Process of type Reference a were added and presented in a new table (Table 9.16).
- The Expanded attribute was added to the set of Sub-Process attributes.
- The TransactionProtocol and TransactionMethod attributes were removed from the set of Sub-Process attributes. These attributes can be found in the definition of a Transaction, which can be found in the Section B.11.10, “Transaction,” on page 271.
- The ProcessRef attribute, within the set of Independent Sub-Process attributes, was changed to be of type Process.
- The Process attribute was removed from the set of Sub-Process attributes.
- The InputMap attribute, within the set of Independent Sub-Process attributes, was renamed to InputPropertyMaps and its cardinality was changed from 0 to many (0-n). In addition, the description was updated to clarify that the mapping was between the properties of the object and the properties of the referenced Process.
- The OutputMap attribute, within the set of Independent Sub-Process attributes, was renamed to OutputPropertyMaps and its cardinality was changed from 0 to many (0-n). In addition, the description was updated to clarify that the mapping was between the properties of the object and the properties of the referenced Process.

9.4.3 Task

A Task is an atomic activity that is included within a Process. A Task is used when the work in the Process is not broken down to a finer level of Process Model detail. Generally, an end-user and/or an application are used to perform the Task when it is executed.

A Task object shares the same shape as the Sub-Process, which is a rectangle that has rounded corners (see Figure 9.12).

- ◆ A Task is a rounded corner rectangle that **MUST** be drawn with a single thin black line.
 - ◆ The use of text, color, size, and lines for a Task **MUST** follow the rules defined in Section 8.3, “Use of Text, Color, Size, and Lines in a Diagram,” on page 26.



Figure 9.12 - A Task Object

BPMN specifies three types of markers for Task: a Loop Marker or a Multiple Instance Marker and a Compensation Marker. A Task may have one or two of these markers (see Figure 9.13).

- ◆ The marker for a Task that is a standard loop **MUST** be a small line with an arrowhead that curls back upon itself.
 - ◆ The Loop Marker **MAY** be used in combination with the Compensation Marker.
- ◆ The marker for a Task that is a multi-instance loop **MUST** be a pair of vertical lines in parallel.
 - ◆ The Multiple Instance Marker **MAY** be used in combination with the Compensation Marker.
- ◆ The marker for a Task that is used for compensation **MUST** be a pair of left facing triangles (like a tape player “rewind” button).
 - ◆ The Compensation Marker **MAY** be used in combination with the Loop Marker or the Multiple Instance Marker.
- ◆ All the markers that are present **MUST** be grouped and the whole group centered at the bottom of the shape.

All the markers that are present will be grouped and centered at the bottom of the shape.



Figure 9.13 - Task Markers

In addition to categories of Task shown above, there are different types of Tasks identified within BPMN to separate the types of inherent behavior that Tasks might represent (see Table 9.2). However, BPMN does not specify any graphical indicators for the different types of Tasks. Modelers or modeling tools may choose to create their own indicators or markers to show the readers of the diagram the type of Task. This is permitted by BPMN as long as the basic shape of the Task (a rounded rectangle) is not modified. The list of Task types may be extended along with any corresponding indicators.

Attributes

The following table displays the set of attributes of a Task, which extends the set of common activity attributes (see Table 9.10):

Table 9.17 - Task Attributes

| Attributes | Description |
|--|--|
| TaskType (Service Receive Send User Script Manual Reference None) None : String | <p>TaskType is an attribute that has a default of Service, but MAY be set to Send, Receive, User, Script, Manual, Reference, or None. The TaskType will be impacted by the Message Flow to and/or from the Task, if Message Flow are used. A TaskType of Receive MUST NOT have an outgoing Message Flow. A TaskType of Send MUST NOT have an incoming Message Flow. A TaskType of Script, Manual, or None MUST NOT have an incoming or an outgoing Message Flow.</p> <p>The TaskType list MAY be extended to include new types.</p> <p>The attributes for specific values of TaskType can be found in Table 9.18 through Table 9.24.</p> |

Service Task

A Service Task is a Task that provides some sort of service, which could be a Web service or an automated application.

The following table displays the set of attributes of a Service Task (where the TaskType attribute is set to “Service”), which extends the set of Task attributes (see Table 9.17):

Table 9.18 - Service Task Attributes

| Attributes | Description |
|--|---|
| InMessage : Message | A Message for the InMessage attribute MUST be entered. This indicates that the Message will be sent at the start of the Task, after the availability of any defined InputSets. A corresponding outgoing Message Flow MAY be shown on the diagram. However, the display of the Message Flow is not required. |
| OutMessage : Message | A Message for the OutMessage attribute MUST be entered. The arrival of this message marks the completion of the Task, which may cause the production of an OutputSet. A corresponding incoming Message Flow MAY be shown on the diagram. However, the display of the Message Flow is not required. |
| Implementation (Web Service Other Unspecified) Web Service : String | This attribute specifies the technology that will be used to send and receive the messages. A Web service is the default technology. |

Receive Task

A Receive Task is a simple Task that is designed to wait for a message to arrive from an external participant (relative to the Business Process). Once the message has been received, the Task is completed.

A Receive Task is often used to start a Process. In a sense, the Process is bootstrapped by the receipt of the message. In order for the Task to Instantiate the Process it must meet one of the following conditions:

- ◆ The Process does not have a Start Event and the Receive Task has no incoming Sequence Flow.

- ◆ The Incoming Sequence Flow for the Receive Task has a source of a Start Event.
 - ◆ Note that no other incoming Sequence Flow are allowed for the Receive Task (in particular, a loop connection from a downstream object).

The following table displays the set of attributes of a Receive Task (where the TaskType attribute is set to “Receive”), which extends the set of Task attributes (see Table 9.17):

Table 9.19 - Receive Task Attributes

| Attributes | Description |
|--|--|
| Message: Message | A Message for the Message attribute MUST be entered. This indicates that the Message will be received by the Task. The Message in this context is equivalent to an <i>in-only</i> message pattern (Web service). A corresponding incoming Message Flow MAY be shown on the diagram. However, the display of the Message Flow is not required. |
| Instantiate False : Boolean | Receive Tasks can be defined as the instantiation mechanism for the Process with the Instantiate attribute. This attribute MAY be set to true if the Task is the first activity after the Start Event or a starting Task if there is no Start Event (i.e., there are no incoming Sequence Flow). Multiple Tasks MAY have this attribute set to True. |
| Implementation (Web Service Other Unspecified) Web Service : String | This attribute specifies the technology that will be used to receive the message. A Web service is the default technology. |

Send Task

A Send Task is a simple Task that is designed to send a message to an external participant (relative to the Business Process). Once the message has been sent, the Task is completed.

The following table displays the set of attributes of a Send Task (where the TaskType attribute is set to “Send”), which extends the set of Task attributes (see Table 9.17):

Table 9.20 - Send Task Attributes

| Attributes | Description |
|--|--|
| Message : Message | A Message for the Message attribute MUST be entered. This indicates that the Message will be sent by the Task. The Message in this context is equivalent to an <i>out-only</i> message pattern (Web service). A corresponding outgoing Message Flow MAY be shown on the diagram. However, the display of the Message Flow is not required. |
| Implementation (Web Service Other Unspecified) Web Service : String | This attribute specifies the technology that will be used to send the message. A Web service is the default technology. |

User Task

A User Task is a typical “workflow” task where a human performer performs the Task with the assistance of a software application and is scheduled through a task list manager of some sort.

The following table displays the set of attributes of a User Task (where the TaskType attribute is set to “User”), which extends the set of Task attributes (see Table 9.17):

Table 9.21 - User Task Attributes

| Attributes | Description |
|--|--|
| Performers (1-n) : String | One or more Performers MAY be entered. The Performers attribute defines the human resource that will be performing the User Task. The Performers entry could be in the form of a specific individual, a group, or an organization. Additional parameters that help define the Performers assignment can be added by a modeling tool. |
| InMessage : Message | A Message for the InMessage attribute MUST be entered. This indicates that the Message will be sent at the start of the Task, after the availability of any defined InputSets. A corresponding outgoing Message Flow MAY be shown on the diagram. However, the display of the Message Flow is not required. |
| OutMessage : Message | A Message for the OutMessage attribute MUST be entered. The arrival of this message marks the completion of the Task, which may cause the production of an OutputSet. A corresponding incoming Message Flow MAY be shown on the diagram. However, the display of the Message Flow is not required. |
| Implementation (Web Service Other Unspecified) Other : String | This attribute specifies the technology that will be used by the Performers to perform the Task. |

Script Task

A Script Task is executed by a business process engine. The modeler or implementer defines a script in a language that the engine can interpret. When the Task is ready to start, the engine will execute the script. When the script is completed, the Task will also be completed.

The following table displays the set of attributes of a Script Task (where the TaskType attribute is set to “Script”), which extends the set of Task attributes (see Table 9.17):

Table 9.22 - Script Task Attributes

| Attributes | Description |
|------------------------------|--|
| Script (0-1) : String | The modeler MAY include a script that can be run when the Task is performed. If a script is not included, then the Task will act equivalent to a TaskType of None. |

Manual Task

A Manual Task is a Task that is expected to be performed without the aid of any business process execution engine or any application. An example of this could be a telephone technician installing a telephone at a customer location.

The following table displays the set of attributes of a Manual Task (where the TaskType attribute is set to “Manual”), which extends the set of Task attributes (see Table 9.17):

Table 9.23 - Manual Task Attributes

| Attributes | Description |
|----------------------------------|--|
| Performers (0-n) : String | One or more Performers MAY be entered. The Performers attribute defines the human resource that will be performing the Manual Task. The Performers entry could be in the form of a specific individual, a group, an organization role or position, or an organization. |

Reference Task

There may be times where a modeler may want to reference another activity that has been defined. If the two (or more) activities share the exact same behavior, then by one referencing the other, the attributes that define the behavior only have to be created once and maintained in only one location.

The following table displays the set of attributes of a Reference Task (where the TaskType attribute is set to “Reference”), which extends the set of Task attributes (see Table 9.17):

Table 9.24 - Reference Task Attributes

| Attributes | Description |
|-----------------------|---|
| TaskRef : Task | The Task being referenced MUST be identified. The attributes for the Task element can be found in Table 9.17. |

Sequence Flow Connections

Section 8.4.1, “Sequence Flow Rules,” on page 27 for the entire set of objects and how they may be source or targets of Sequence Flow.

- ◆ A Task MAY be a target for Sequence Flow; it can have multiple incoming Flow. Incoming Flow MAY be from an alternative path and/or a parallel paths.

Note – If the Task has multiple incoming Sequence Flow, then this is considered uncontrolled flow. This means that when a Token arrives from one of the Paths, the Task will be instantiated. It will not wait for the arrival of Tokens from the other paths. If another Token arrives from the same path or another path, then a separate instance of the Task will be created. If the flow needs to be controlled, then the flow should converge with a Gateway that precedes the Task (see Section 9.5, “Gateways,” on page 68 for more information on Gateways).

- ◆ If the Task does not have an incoming Sequence Flow, and there is no Start Event for the Process, then the Task MUST be instantiated when the process is instantiated.
 - ◆ Exceptions to this are Tasks that are defined as being Compensation activities (have the Compensation Marker). Compensation Tasks are not considered a part of the Normal Flow and MUST NOT be instantiated when the Process is instantiated.
- ◆ A Task MAY be a source for Sequence Flow; it can have multiple outgoing Flow. If there are multiple outgoing Sequence Flow, then this means that a separate parallel path is being created for each Flow.

Tokens will be generated for each outgoing Sequence Flow from the Task. The TokenIds for each of the Tokens will be set such that it can be identified that the Tokens are all from the same parallel Fork (AND-Split) as well as the number of Tokens that exist in parallel.

- ◆ If the Task does not have an outgoing Sequence Flow, and there is no End Event for the Process, then the Task marks the end of one or more paths in the Process. When the Task ends and there are no other parallel paths active, then the Process **MUST** be completed.
- ◆ Exceptions to this are Tasks that are defined as being Compensation activities (have the Compensation Marker). Compensation Tasks are not considered a part of the Normal Flow and **MUST NOT** mark the end of the Process.

Message Flow Connections

Section 8.4.2, “Message Flow Rules,” on page 28 for the entire set of objects and how they may be source or targets of Message Flow.

Note – All Message Flow must connect two separate Pools. They can connect to the Pool boundary or to Flow Objects within the Pool boundary. They cannot connect two objects within the same Pool.

- ◆ A Task **MAY** be the target for Message Flow; it can have zero or one incoming Message Flow.
- ◆ A Task **MAY** be a source for Message Flow; it can have zero or more outgoing Message Flow.

Changes Since 1.0 Draft Version

These are the changes since the last publicly released version:

- The constraint about the fill of the Task was removed.
- The TaskType attribute, within the set of Task attributes, was updated to include a new type named Reference. Also, the Abstract TaskType was removed.

9.5 Gateways

Gateways are modeling elements that are used to control how Sequence Flow interact as they converge and diverge within a Process. If the flow does not need to be controlled, then a Gateway is not needed. The term “Gateway” implies that there is a gating mechanism that either allows or disallows passage through the Gateway--that is, as Tokens arrive at a Gateway, they can be merged together on input and/or split apart on output as the Gateway mechanisms are invoked. To be more descriptive, a Gateway is actually a collection of “Gates.” There are different types of Gateways (as described below) and the behavior of each type Gateway will determine how many of the Gates will be available for the continuation of flow. There will be one Gate for each outgoing Sequence Flow of the Gateway.

A Gateway is a diamond (see Figure 9.14), which has been used in many flow chart notations for exclusive branching and is familiar to most modelers.

- ◆ A Gateway is a diamond that **MUST** be drawn with a single thin black line.
- ◆ The use of text, color, size, and lines for a Gateway **MUST** follow the rules defined in Section 8.3, “Use of Text, Color, Size, and Lines in a Diagram,” on page 26.

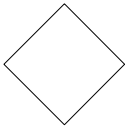

Figure 9.14 - A Gateway

Note – Although the shape of a Gateway is a diamond, it is not a requirement that incoming and outgoing Sequence Flow must connect to the corners of the diamond. Sequence Flow can connect to any position on the boundary of the Gateway shape.

Gateways can define all the types of business process Sequence Flow behavior: Decisions/branching (OR-Split; exclusive--XOR, inclusive--OR, and complex), merging (OR-Join), forking (AND-Split), and joining (AND-Join). Thus, while the diamond has been used traditionally for exclusive decisions, BPMN extends the behavior of the diamonds to reflect any type of Sequence Flow control. Each type of Gateway will have an internal indicator or marker to show the type of Gateway that is being used (see Figure 9.15).

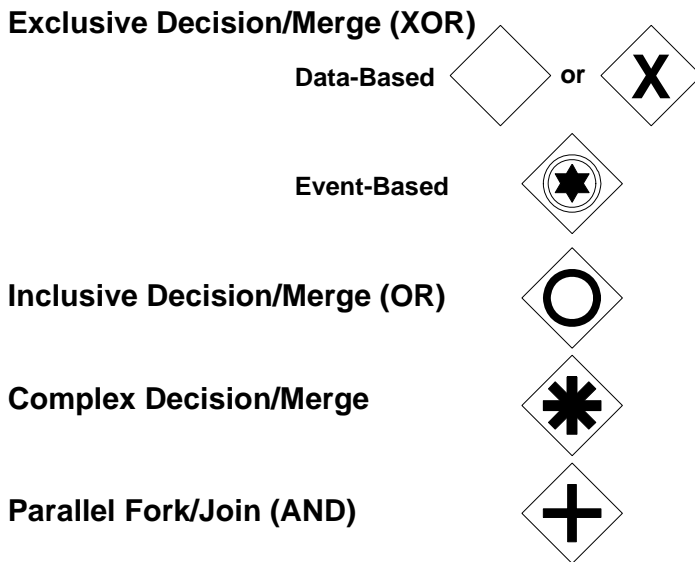

Figure 9.15 - The Different types of Gateways

- ◆ The internal marker associated with the Gateway MUST be placed inside the shape, in any size or location, depending on the preference of the modeler or modeling tool vendor, with the exception that the marker for the Data-Based Exclusive Gateway is not required.

The Gateways will control the flow of both diverging and/or converging Sequence Flow. That is, a particular Gateway could have multiple incoming Sequence Flow and multiple outgoing Sequence Flow at the same time. The type of Gateway will determine the same type of behavior for both the diverging and converging Sequence Flow. Modelers and modeling tools may want to enforce a best practice of a Gateway only performing one of these functions. Thus, it would take two sequential Gateways to first converge and then diverge the Sequence Flow.

Changes Since 1.0 Draft Version

These are the changes since the last publicly released version:

- The constraint about the fill of the Gateway was removed.
- The constraint for placing the internal marker inside the Gateway was changed from MAY to MUST.

9.5.1 Common Gateway Features

Common Gateway Attributes

The following table displays the attributes common to Gateways, and which extends the set of common Flow Object attributes (see Table 9.2):

Table 9.25 - Common Gateway Attributes

| Attributes | Description |
|--|--|
| GatewayType (XOR OR Complex AND) XOR : String | GatewayType is by default XOR. The GatewayType MAY be set to OR, Complex, or AND. The GatewayType will determine the behavior of the Gateway, both for incoming and outgoing Sequence Flow, and will determine the internal indicator (as shown in Figure 9.15). |

Common Gateway Sequence Flow Connections

This section applies to all Gateways. Additional Sequence Flow Connection rules will be specified for each type of Gateway in the sections below. See Section 8.4.1, “Sequence Flow Rules,” on page 27 for the entire set of objects and how they may be source or targets of Sequence Flow.

- ◆ A Gateway MAY be a target for Sequence Flow; it can have zero or more incoming Sequence Flow. An incoming Flow MAY be from an alternative path or a parallel path.
 - ◆ If the Gateway does not have an incoming Sequence Flow, and there is no Start Event for the Process, then the Gateway’s divergence behavior, depending on the GatewayType attribute (see below), SHALL be performed when the Process is instantiated.
- ◆ A Gateway MAY be a source of Sequence Flow; it can have zero or more outgoing Flow.
- ◆ A Gateway MAY have both multiple incoming and outgoing Sequence Flow.

Note – The incoming and outgoing Sequence Flow are not required to attach to the corners of the Gateway’s diamond shape. Sequence Flow can attach to any location on the boundary of a Gateway.

Message Flow Connections

This section applies to all Gateways. See Section 8.4.2, “Message Flow Rules,” on page 28 for the entire set of objects and how they may be source or targets of Message Flow.

- ◆ An Gateway MUST NOT be a target for Message Flow.
- ◆ An Gateway MUST NOT be a source for Message Flow.

9.5.2 Exclusive Gateways (XOR)

Exclusive Gateways (Decisions) are locations within a business process where the Sequence Flow can take two or more alternative paths. This is basically the “fork in the road” for a process. For a given performance (or instance) of the process, only one of the paths can be taken (this should not be confused with forking of paths—refer to “Forking Flow” on page 110). A Decision is not an activity from the business process perspective, but is a type of Gateway that controls the Sequence Flow between activities. It can be thought of as a question that is asked at that point in the Process. The question has a defined set of alternative answers (Gates). Each Decision Gate is associated with a condition expression found within an outgoing Sequence Flow. When a Gate is chosen during the performance of the Process, the corresponding Sequence Flow is then chosen. A Token arriving at the Decision would be directed down the appropriate path, based on the chosen Gate.

The Exclusive Decision has two or more outgoing Sequence Flow, but only one of them may be taken during the performance of the Process. Thus, the Exclusive Decision defines a set of alternative paths for the Token to take as it traverses the Flow. There are two types of Exclusive Decisions: Data-Based and Event-Based.

Data-Based

The Data-Based Exclusive Gateways are the most commonly used type of Gateways. The set of Gates for Data-Based Exclusive Decisions is based on the boolean expression contained in the ConditionExpression attribute of the outgoing Sequence Flow of the Gateway. These expressions use the values of process data to determine which path should be taken (hence the name Data-Based).

Note – BPMN does not specify the format of the expressions used in Gateways or any other BPMN element that uses expressions.

- ◆ The Data-Based Exclusive Gateway **MAY** use a marker that is shaped like an “X” and is placed within the Gateway diamond (see Figure 9.17) to distinguish it from other Gateways. This marker is not required (see Figure 9.16).
- ◆ A Diagram **SHOULD** be consistent in the use of the “X” internal indicator. That is, a Diagram **SHOULD NOT** have some Gateways with an indicator and some Gateways without an indicator.

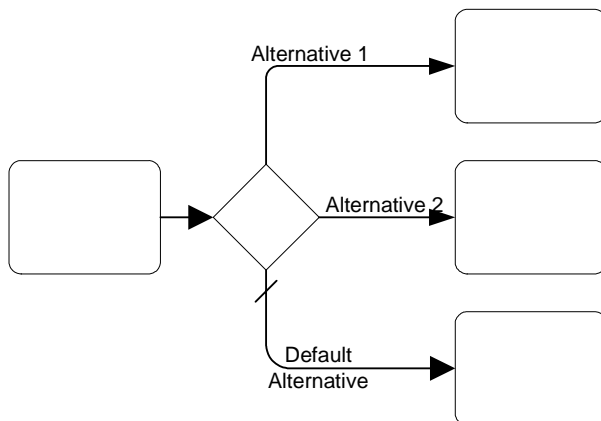

Figure 9.16 - An Exclusive Data-Based Decision (Gateway) Example without the Internal Indicator

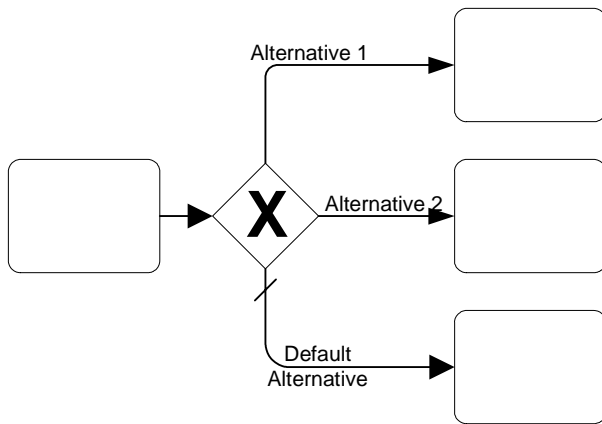

Figure 9.17 - A Data-Based Exclusive Decision (Gateway) Example with the Internal Indicator

The conditions for the alternative Gates should be evaluated in a specific order. The first one that evaluates as TRUE will determine the Sequence Flow that will be taken. Since the behavior of this Gateway is exclusive, any other conditions that may actually be TRUE will be ignored--only one Gate can be chosen. One of the Gates may be “default” (or otherwise), and is the last Gate considered. This means that if none of the other Gates are chosen, then the default Gate will be chosen—along with its associated Sequence Flow.

The default Gate is not mandatory for a Gateway. This means that if it is not used, then it is up to the modeler to insure that at least one Gate be valid at runtime. BPMN does not specify what will happen if there are no valid Gates. However, BPMN does specify that there MUST NOT be implicit flow and that all Normal Flow of a Process must be expressed through Sequence Flow. This would mean that a Process Model that has a Gateway that potentially does not have a valid Gate at runtime is an invalid model.

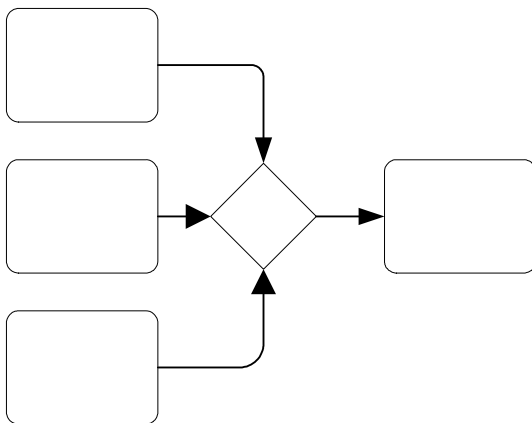

Figure 9.18 - An Exclusive Merge (Gateway) (without the Internal Indicator)

Exclusive Gateways can also be used as a merge (see Figure 9.18) for alternative Sequence Flow, although it is rarely required for the modeler to use them this way. The merging behavior of the Gateway can also be modeled as seen in Figure 9.19. The behavior of Figure 9.18 and Figure 9.19 are the same if all the incoming flow are alternative.

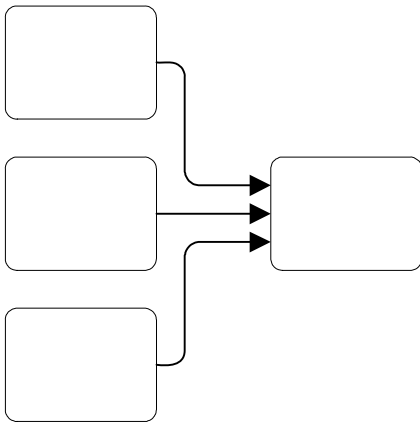

Figure 9.19 - Uncontrolled Merging of Sequence Flow

There are certain situations where an Exclusive Gateway is required to act as a merging object. In Figure 9.21 an Exclusive Gateway (labeled “Merge”) merges two alternative Sequence Flow that were generated by an upstream Decision. The alternative Sequence Flow are merged in preparation for an Parallel Gateway that synchronizes a set of parallel Sequence Flow that were generated even further upstream. If the merging Gateway was not used, then there would have been four incoming Sequence Flow into the Parallel Gateway. However, only three of the four Sequence Flow would ever pass a Token at one time. Thus, the Gateway would be waiting for a fourth Token that would never arrive. Thus, the Process would be stuck at the point of the Parallel Gateway.

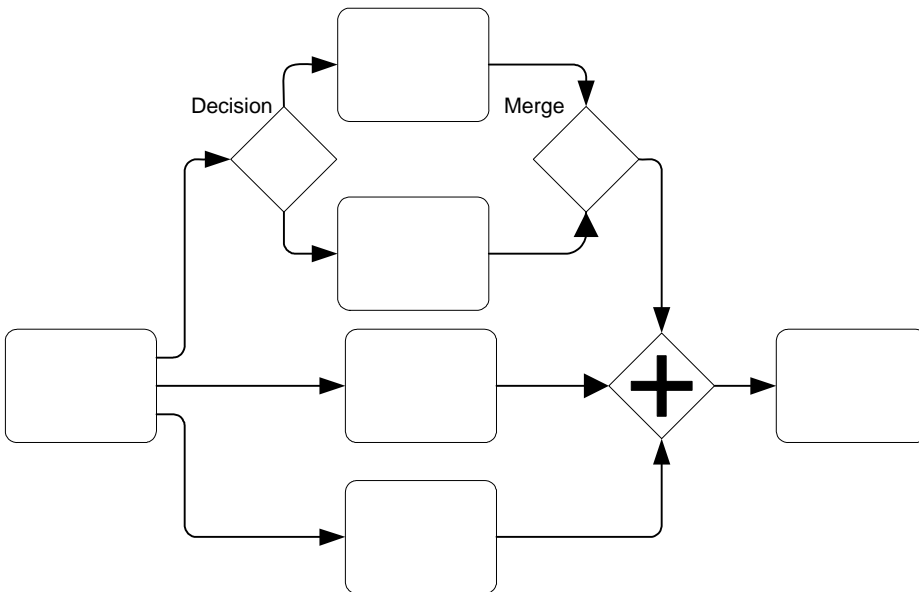

Figure 9.20 - Exclusive Gateway that merges Sequence Flow prior to an Parallel Gateway

In simple situations, Exclusive Gateways need not be used for merging Sequence Flow, but there are more complex situations where they are required. Thus, a modeler should always be aware of the behavior of a situation where Sequence Flow are uncontrolled. Some modelers or modeling tools may, in fact, require that Exclusive Gateways be used in all situations as a matter of Best Practice.

Attributes

The following table displays the attributes for an Data-Based Exclusive Gateway. These attributes only apply if the GatewayType attribute is set to XOR. The following attributes extend the set of common Gateway attributes (see Table 9.30):

Table 9.26 - Data-Based Exclusive Gateway Attributes

| Attributes | Description |
|---|--|
| XORType (Data Event) Data : String | XORType is by default Data. The XORType MAY be set to Event. Since Data-Based XOR Gateways are the subject of this section, the attribute MUST be set to Data for the attributes and behavior defined in this section to apply to the Gateway. |
| MarkerVisible False : Boolean | This attribute determines if the XOR Marker is displayed in the center of the Gateway diamond (an “X”). The marker is displayed if the attribute is True and it is not displayed if the attribute is False. By default, the marker is not displayed. |
| Gates (0-n) : Gate | There MAY be zero or more Gates. Zero Gates are allowed if the Gateway is last object in a Process flow and there are no Start or End Events for the Process. If there are zero or only one incoming Sequence Flow (i.e, the Gateway is acting as a Decision), then there MUST be at least one Gate. In this case, if there is no DefaultGate, then there MUST be at least two Gates. |
| [Gate] OutgoingSequenceFlow: SequenceFlow | Each Gate MUST have an associated Sequence Flow. The Sequence Flow MUST have its Condition attribute set to Expression and MUST have a valid ConditionExpression. The attributes of a Sequence Flow can be found in the Section 10.1.2, “Sequence Flow,” on page 100. If there is only one Gate (i.e., the Gateway is acting only as a Merge), then Sequence Flow MUST have its Condition set to None. |
| [Gate] Assignments (0-n) : Assignment | One or more assignment expressions MAY be made for each Gate. The Assignment SHALL be performed when the Gate is selected. The Assignment is defined in the Section B.11.1, “Assignment,” on page 268. |
| DefaultGate (0-1) : Gate | A Default Gate MAY be specified. |
| [Gate] OutgoingSequenceFlow: SequenceFlow | If there is a DefaultGate, then it MUST have an associated Sequence Flow. The Sequence Flow SHALL have the Default Indicator (see Figure 9.16). The Sequence Flow MUST have its Condition attribute set to Default. The attributes of a Sequence Flow can be found in the Section 10.1.2, “Sequence Flow,” on page 100. |
| [Gate] Assignments (0-n) : Assignment | One or more assignment expressions MAY be made for the DefaultGate. The Assignment SHALL be performed when the DefaultGate is selected. The details of Assignment is defined in the Section B.11.1, “Assignment,” on page 268. |

Sequence Flow Connections

This section extends the basic Gateway Sequence Flow connection rules as defined in “Common Gateway Sequence Flow Connections” on page 70. Section 8.4.1, “Sequence Flow Rules,” on page 27 for the entire set of objects and how they may be source or targets of Sequence Flow.

To define the exclusive nature of this Gateway’s behavior for converging Sequence Flow:

- ◆ If there are multiple incoming Sequence Flow, all of them will be used to continue the flow of the Process (as if there were no Gateway). That is,
 - ◆ Process flow SHALL continue when a signal (a Token) arrives from any of a set of Sequence Flow.
 - ◆ Signals from other Sequence Flow within that set may arrive at other times and the flow will continue when they arrive as well, without consideration or synchronization of signals that have arrived from other Sequence Flow.

To define the exclusive nature of this Gateway’s behavior for diverging Sequence Flow:

- ◆ If there are multiple outgoing Sequence Flow, then only one Gate (or the DefaultGate) SHALL be selected during performance of the Process.
 - ◆ The Gate SHALL be chosen based on the result of evaluating the ConditionExpression that is defined for the Sequence Flow associated with the Gate.
 - ◆ The Conditions associated with the Gates SHALL be evaluated in the order in which the Gates appear on the list for the Gateway.
 - ◆ If a ConditionExpression is evaluated as “TRUE,” then that Gate SHALL be chosen and any Gates remaining on the list MUST NOT be evaluated.
 - ◆ If none of the ConditionExpressions for the Gates are evaluated as “TRUE,” then the DefaultGate SHALL be chosen.

Note – If the Gateway does not have a DefaultGate and none of the Gate ConditionExpressions are evaluated as “TRUE,” then the Process is considered to have an invalid model.

Changes Since 1.0 Draft Version

These are the changes since the last publicly released version:

- The Gates and DefaultGate attributes, within the set of Data-Based Exclusive Gateway attributes, were changed to type Object.

Event-Based

The inclusion of Event-Based Exclusive Gateways is the result of recent developments in the handling of distributed systems (e.g., with pi-calculus) and will map to the BPEL4WS *pick*. On the input side, their behavior is the same as a Data-Based Exclusive Gateway (see “Data-Based” on page 71). On the output side, the basic idea is that this Decision represents a branching point in the process where the alternatives are based on events that occurs at that point in the Process, rather than the evaluation of expressions using process data. A specific event, usually the receipt of a message, determines which of the paths will be taken. For example, if a company is waiting for a response from a customer, they will perform one set of activities if the customer responds “Yes” and another set of activities if the customer responds “No.” The customer’s response determines which path is taken. The identity of the Message determines which path is taken. That is, the “Yes” Message and the “No” message are different messages—they are not the same message with

different values within a property of the Message. The receipt of the message can be modeled with a Task of TaskType Receive or an Intermediate Event with a Message Trigger. In addition to Messages, other Triggers for Intermediate Events can be used, such as Timers and Errors.

- ◆ The Event-Based Exclusive Gateway MUST use a marker that is the same as the Multiple Intermediate Event and is placed within the Gateway diamond (see Figure 9.21 and Figure 9.22) to distinguish it from other Gateways.
- ◆ The Event-Based Exclusive Decisions are configured by having outgoing Sequence Flow target a Task of TaskType Receive or an Intermediate Event (see Figure 9.21 and Figure 9.22).
- ◆ All of the outgoing Sequence Flow must have this type of target; there cannot be a mixing of condition expressions and Intermediate Events for a given Decision.

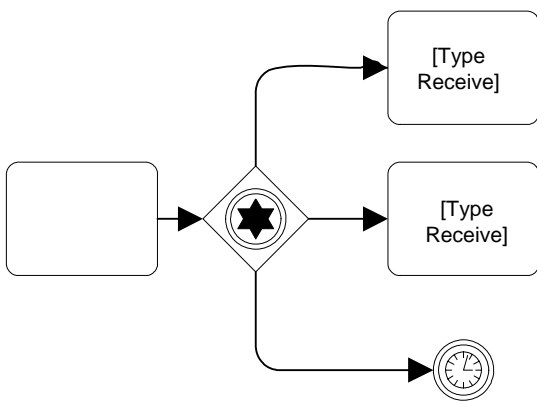

Figure 9.21 - An Event-Based Decision (Gateway) Example Using Receive Tasks

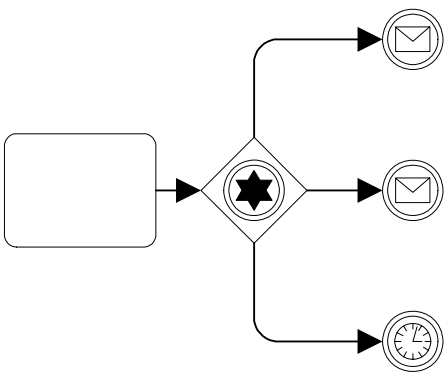

Figure 9.22 - An Event-Based Decision (Gateway) Example Using Message Events

To relate the Event-Based Exclusive Gateway to BPEL4WS, the Gateway diamond marks the location of a BPEL4WS *pick* and the Intermediate Events that follow the Decision become the event handlers of the *pick* or *choice*. The activities that follow the Intermediate Events become the contents of the *activity sets* for the event handlers. The boundaries of the activity sets is actually determined by the configuration of the process; that is, the boundaries extend to where all the alternative paths are finally joined together (which could be the end of the Process).

Because this Gateway is an Exclusive Gateway, the merging functionality for the Event-Based Exclusive Gateway is the same as the Data-Based Exclusive Gateway described in the previous section.

A Gateway can be used to start a Process. In a sense, the Process is bootstrapped by the receipt of a message. The receipt of any of the messages defined by the Gateway configuration will instantiate the Process. Thus, the Gateway provides a set of alternative ways for the Process to begin.

In order for the Gateway to Instantiate the Process it must meet one of the following conditions:

- ◆ The Process does not have a Start Event and the Gateway has no incoming Sequence Flow.
- ◆ The Incoming Sequence Flow for the Gateway has a source of a Start Event.
 - ◆ Note that no other incoming Sequence Flow are allowed for the Gateway (in particular, a loop connection from a downstream object).
- ◆ The Targets for the Gateway’s outgoing Sequence Flow MUST NOT be a Timer Intermediate Event.

Attributes

The following table displays the attributes for an Event-Based Exclusive Gateway. These attributes only apply if the GatewayType attribute is set to XOR. The following attributes extend the set of common Gateway attributes (see Table 9.31):

Table 9.27 - Event-Based Exclusive Gateway Attributes

| Attributes | Description |
|--|--|
| XORType (Data Event) Event : String | XORType is by default Data. The XORType MAY be set to Event. Since Event-Based XOR Gateways is the subject of this section, the attribute MUST be set to Event for the attributes and behavior defined in this section to apply to the Gateway. |
| Instantiate False : Boolean | Event-Based Gateways can be defined as the instantiation mechanism for the Process with the Instantiate attribute. This attribute MAY be set to true if the Gateway is the first element after the Start Event or a starting Gateway if there is no Start Event (i.e., there are no incoming Sequence Flow). |
| Gates (2-n) : Gate | There MUST be two or more Gates. (Note that this type of Gateway does not act <i>only</i> as a Merge--it is always a Decision, at least.) |
| [Gate] OutgoingSequenceFlow : SequenceFlow | Each Gate MUST have an associated Sequence Flow. The Sequence Flow MUST have its Condition attribute set to None (there is not an evaluation of a condition expression). The attributes of a Sequence Flow can be found in the Section 10.1.2, “Sequence Flow,” on page 100. |
| [Gate] Assignments (0-n) : Assignment | One or more assignment expressions MAY be made for each Gate. The Assignment SHALL be performed when the Gate is selected. The details of Assignment is defined in the Section B.11.1, “Assignment,” on page 268. |

Sequence Flow Connections

This section extends the basic Gateway Sequence Flow connection rules as defined in “Common Gateway Sequence Flow Connections” on page 70. See Section 8.4.1, “Sequence Flow Rules,” on page 27 for the entire set of objects and how they may be source or targets of Sequence Flow.

To define the exclusive nature of this Gateway’s behavior for converging Sequence Flow:

- ◆ If there are multiple incoming Sequence Flow, all of them will be used to continue the flow of the Process (as if there were no Gateway). That is,
 - ◆ Process flow SHALL continue when a signal (a Token) arrives from any of a set of Sequence Flow.
 - ◆ Signals from other Sequence Flow within that set may arrive at other times and the flow will continue when they arrive as well, without consideration or synchronization of signals that have arrived from other Sequence Flow.

To define the exclusive nature of this Gateway's behavior for diverging Sequence Flow:

- ◆ Only one Gate SHALL be selected during performance of the Process.
 - ◆ The Gate SHALL be chosen based on the Target of the Gate's Sequence Flow.
 - ◆ If a Target is instantiated (e.g., a message is received or a time is exceeded), then that Gate SHALL be chosen and the remaining Gates MUST NOT be evaluated (i.e., their Targets will be disabled).
- ◆ The outgoing Sequence Flow Condition attribute MUST be set to None.
- ◆ The Target of the Gateway's outgoing Sequence Flow MUST be one of the following objects:
 - ◆ Task with the TaskType attribute set to Receive.
 - ◆ Intermediate Event with the Trigger attribute set to Message, Timer, Rule, or Link.
 - ◆ If one Gate Target is a Task, then an Intermediate Event with a Trigger Message MUST NOT be used as a Target for another Gate. That is, messages MUST be received by only Receive Tasks or only Message Events, but not a mixture of both for a given Gateway.

Changes Since 1.0 Draft Version

These are the changes since the last publicly released version:

- A description of how Event-Based Gateways can instantiate a Process was added.
- The Instantiate attribute was added to the set of Event-Based Exclusive Gateway attributes.
- The Target attribute was removed from the set of Event-Based Gateway attributes, as it duplicated information provided in the semantic definition of the Gateway.
- The Error Intermediate Event was removed as a possible target for the Sequence Flow that exit the Gateway.

9.5.3 Inclusive Gateways (OR)

This Decision represents a branching point where Alternatives are based on conditional expressions contained within outgoing Sequence Flow. However, in this case, the True evaluation of one condition expression does not exclude the evaluation of other condition expressions. All Sequence Flow with a True evaluation will be traversed by a Token. In some sense it like is a grouping of related independent Binary (Yes/No) Decisions--and can be modeled that way. Since each path is independent, all combinations of the paths may be taken, from zero to all. However, it should be designed so that at least one path is taken.

Note – If none of the Inclusive Decision Gate ConditionExpressions are evaluated as “TRUE,” then the Process is considered to have an invalid model.

There are two mechanism for modeling this type of Decision:

The first method for modeling Inclusive Decision situations does not actually use an Inclusive Gateway, but instead uses a collection of conditional Sequence Flow, marked with mini-diamonds--the Gates without the Gateway (see Figure 9.23). Conditional Sequence Flow have their Condition attribute set to Expression and the ConditionExpression attribute set to a boolean mathematical expression based on information available to the Process. These Sequence Flow are indicated by a “mini-diamond” marker at the start of the Sequence Flow line.

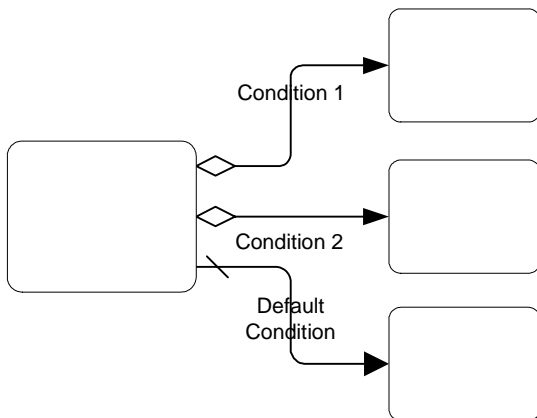

Figure 9.23 - An Inclusive Decision using Conditional Sequence Flow

There are some restrictions in using the conditional Sequence Flow (with mini-diamonds):

- The source object **MUST NOT** be an Event. The source object **MAY** a Gateway, but the mini-diamond **MUST NOT** be displayed in this case. The source object **MAY** be an activity (Task or Sub-Process) and the mini-diamond **SHALL** be displayed in this case.
 - A source Gateway **MUST NOT** be of type AND (Parallel).
- If a conditional Sequence Flow is used from a source activity, then there **MUST** be at least one other outgoing Sequence Flow from that activity
 - The additional Sequence Flow(s) **MAY** also be conditional, but it is not required that they are conditional.

The second method for modeling Inclusive Decision situations uses an OR Gateway (see Figure 9.24), sometimes in combination with other Gateways. A marker will be placed in the center of the Gateway to indicate that the behavior of the Gateway is inclusive.

- ◆ The Inclusive Gateway **MUST** use a marker that is in the shape of a circle or an “O” and is placed within the Gateway diamond (see Figure 9.24) to distinguish it from other Gateways.

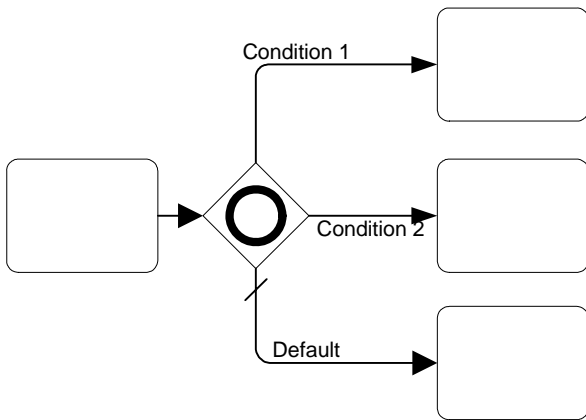

Figure 9.24 - An Inclusive Decision using an OR Gateway

The behavior of the model depicted in Figure 9.23 is equivalent to the behavior of the model depicted in Figure 9.24. Again, it is up to the modeler to insure that at least one of the conditions will be TRUE when the Process is performed.

When the Inclusive Gateway is used as a Merge, it will wait for (synchronize) all Tokens that have been produced upstream. It does not require that all incoming Sequence Flow produce a Token (as the Parallel Gateway does). It requires that all Sequence Flow that were actually produced by an upstream (by an Inclusive OR situation, for example). If an upstream Inclusive OR produces two out of a possible three Tokens, then a downstream Inclusive OR will synchronize those two Tokens and not wait for another Token, even though there are three incoming Sequence Flow (see Figure 9.25).

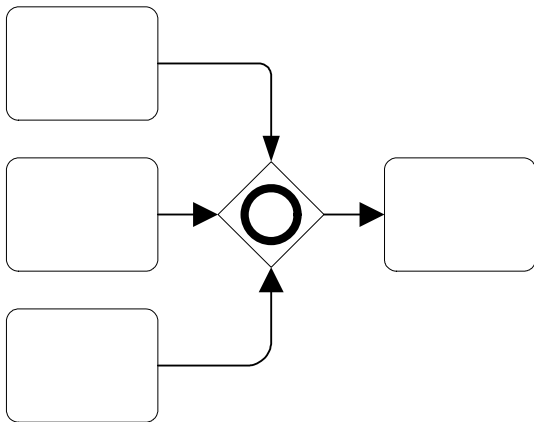

Figure 9.25 - An Inclusive Gateway Merging Sequence Flow

Attributes

The following table displays the attributes for an Inclusive Gateway. These attributes only apply if the GatewayType attribute is set to OR. The following attributes extend the set of common Gateway attributes (see Table 9.30):

Table 9.28 - Inclusive Gateway Attributes

| Attributes | Description |
|--|---|
| Gates (0-n) : Gate | There MAY be zero or more Gates. Zero Gates are allowed if the Gateway is last object in a Process flow and there are no Start or End Events for the Process. If there are zero or only one incoming Sequence Flow (i.e, the Gateway is acting as a Decision), then there MUST be at least two Gates. |
| [Gate] OutgoingSequenceFlow: SequenceFlow | Each Gate MUST have an associated Sequence Flow. The Sequence Flow MUST have its Condition attribute set to Expression and MUST have a valid ConditionExpression. The ConditionExpression MUST be unique for all the Gates within the Gateway. The attributes of a Sequence Flow can be found in Section 10.1.2, “Sequence Flow,” on page 100. If there is only one Gate (i.e., the Gateway is acting only as a Merge), then Sequence Flow MUST have its Condition attribute set to None. |
| [Gate] Assignments (0-n) : Assignment | One or more assignment expressions MAY be made for each Gate. The Assignment SHALL be performed when the Gate is selected. The details of Assignment is defined in Section B.11.1, “Assignment,” on page 268. |
| DefaultGate (0-1) : Gate | A Default Gate MAY be specified. |
| [Gate] OutgoingSequenceFlow: SequenceFlow | If there is a DefaultGate, then it MUST have an associated Sequence Flow. The Sequence Flow SHALL have the Default Indicator (see Figure 9.24). The Sequence Flow MUST have its Condition attribute set to Default. The attributes of a Sequence Flow can be found in Section 10.1.2, “Sequence Flow,” on page 100. |
| [Gate] Assignments (0-n) : Assignment | Zero or more assignments MAY be made for the DefaultGate. The Assignment SHALL be performed when the DefaultGate is selected. The details of Assignment is defined in Section B.11.1, “Assignment,” on page 268. |

Sequence Flow Connections

This section extends the basic Gateway Sequence Flow connection rules as defined in “Common Gateway Sequence Flow Connections” on page 70. See Section 8.4.1, “Sequence Flow Rules,” on page 27 for the entire set of objects and how they may be source or targets of Sequence Flow.

To define the inclusive nature of this Gateway’s behavior for converging Sequence Flow:

- ◆ If there are multiple incoming Sequence Flow, one or more of them will be used to continue the flow of the Process. That is,
 - ◆ Process flow SHALL continue when the signals (Tokens) arrive from all of the incoming Sequence Flow that are expecting a signal based on the upstream structure of the Process (e.g., an upstream Inclusive Decision).
 - ◆ Some of the incoming Sequence Flow will not have signals and the pattern of which Sequence Flow will have signals may change for different instantiations of the Process.

Note – Incoming Sequence Flow that have a source that is a downstream activity (that is, is part of a loop) will be treated differently than those that have an upstream source. They will be considered as part of a different set of Sequence Flow from those Sequence Flow that have a source that is an upstream activity.

To define the inclusive nature of this Gateway’s behavior for diverging Sequence Flow:

- ◆ One or more Gates SHALL be selected during performance of the Process.
 - ◆ The Gates SHALL be chosen based on the Condition expression that is defined for the Sequence Flow associated with the Gates.
 - ◆ The Condition associated with all Gates SHALL be evaluated.
 - ◆ If a Condition is evaluated as “TRUE,” then that Gate SHALL be chosen, independent of what other Gates have or have not been chosen.
 - ◆ If none of the ConditionExpressions for the Gates are evaluated as “TRUE,” then the DefaultGate SHALL be chosen.

Changes Since 1.0 Draft Version

These are the changes since the last publicly released version:

- Figure 9.23 and Figure 9.24 were updated to show three conditional Sequence Flow, one of which has a default condition.
- The DefaultGate attribute, with supporting attributes, was added to the set of Inclusive Gateway Attributes.

9.5.4 Complex Gateways

BPMN includes a Complex Gateway to handle situations that are not easily handled through the other types of Gateways. Complex Gateways can also be used to combine a set of linked simple Gateways into a single, more compact situation. Modelers can provide complex expressions that determine the merging and/or splitting behavior of the Gateway.

- ◆ The Complex Gateway MUST use a marker that is in the shape of an asterisk and is placed within the Gateway diamond (see Figure 9.26) to distinguish it from other Gateways.

When the Gateway is used as a Decision (see Figure 9.26), then an expression determines which of the outgoing Sequence Flow will be chosen for the Process to continue. The expression may refer to process data and the status of the incoming Sequence Flow. For example, an expression may evaluate Process data and then select different sets of outgoing Sequence Flow, based on the results of the evaluation. However, The expression should be designed so that at least one of the outgoing Sequence Flow will be chosen.

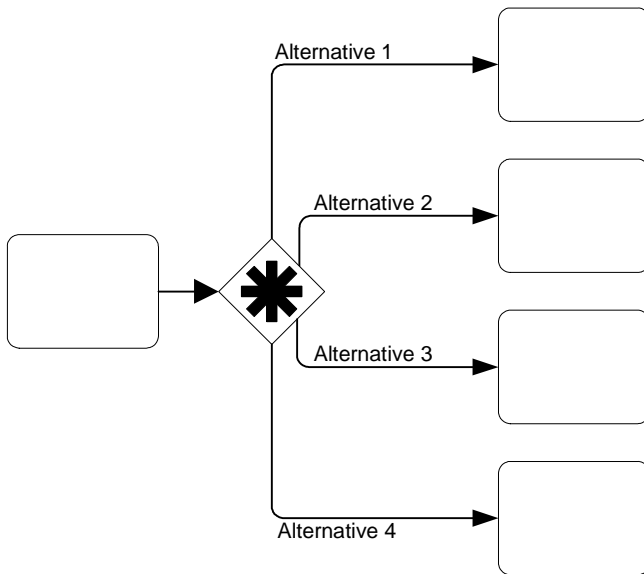

Figure 9.26 - A Complex Decision (Gateway)

When the Gateway is used as a Merge (see Figure 9.27), then there will be an expression that will determine which of the incoming Sequence Flow will be required for the Process to continue. The expression may refer to process data and the status of the incoming Sequence Flow. For example, an expression may specify that any 3 out of 5 incoming Tokens will continue the Process. Another example would be an expression that specifies that a Token is required from Sequence Flow “a” and that a Token from either Sequence Flow “b” or “c” is acceptable. However, the expression should be designed so that the Process is not stalled at that location.

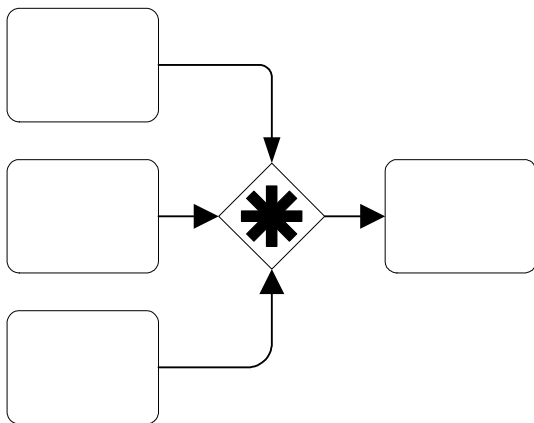

Figure 9.27 - A Complex Merge (Gateway)

Attributes

The following table displays the attributes for a Complex Gateway. These attributes only apply if the GatewayType attribute is set to Complex. The following attributes extend the set of common Gateway attributes (see Table 9.30):

Table 9.29 - Complex Gateway Attributes

| Attributes | Description |
|--|--|
| Gates (0-n) : Gate | There MAY be zero or more Gates. Zero Gates are allowed if the Gateway is last object in a Process flow and there are no Start or End Events for the Process. If there are zero or only one incoming Sequence Flow, then there MUST be at least two Gates. |
| [Gate] OutgoingSequenceFlow : SequenceFlow | Each Gate MUST have an associated Sequence Flow. The Sequence Flow MUST have its Condition attribute set to None. The attributes of a Sequence Flow can be found in Section 10.1.2, “Sequence Flow,” on page 100. |
| [Gate] Assignments (0-n) : Assignment | One or more assignment expressions MAY be made for each Gate. The Assignment SHALL be performed when the Gate is selected. The details of Assignment is defined in Section B.11.1, “Assignment,” on page 268. |
| IncomingCondition (0-1) : Expression | If there are multiple incoming Sequence Flow, an IncomingCondition expression MUST be set by the modeler. This will consist of an expression that can reference Sequence Flow names and/or Process Properties (Data). |
| OutgoingCondition (0-1) : Expression | If there are multiple outgoing Sequence Flow, an OutgoingCondition expression MUST be set by the modeler. This will consist of an expression that can reference (outgoing) Sequence Flow Ids and/or Process Properties (Data). |

Sequence Flow Connections

This section extends the basic Gateway Sequence Flow connection rules as defined in “Common Gateway Sequence Flow Connections” on page 70. See Section 8.4.1, “Sequence Flow Rules,” on page 27 for the entire set of objects and how they may be source or targets of Sequence Flow.

To define the complex nature of this Gateway’s behavior for converging Sequence Flow:

- ◆ If there are multiple incoming Sequence Flow, one or more of them will be used to continue the flow of the Process. The exact combination of incoming Sequence Flow will be determined by the Gateway’s IncomingCondition expression.
 - ◆ Process flow SHALL continue when the appropriate number of signals (Tokens) arrives from appropriate incoming Sequence Flow.
 - ◆ Signals from other Sequence Flow within that set MAY arrive, but they MUST NOT be used to continue the flow of the Process.

Note – Incoming Sequence Flow that have a source that is a downstream activity (that is, is part of a loop) will be treated differently than those that have an upstream source. They will be considered as part of a different set of Sequence Flow from those Sequence Flow that have a source that is an upstream activity.

To define the inclusive nature of this Gateway’s behavior for diverging Sequence Flow:

- ◆ One or more Gates SHALL be selected during performance of the Process.
 - ◆ The Gates SHALL be chosen based on the Gateway’s OutgoingCondition expression.

Changes Since 1.0 Draft Version

These are the changes since the last publicly released version:

- The Assignments attribute, supporting the Gates attribute, within the set of Complex Gateway attributes, was updated.

9.5.5 Parallel Gateways (AND)

Parallel Gateways provide a mechanism to synchronize parallel flow and to create parallel flow. These Gateways are not required to create parallel flow, but they can be used to clarify the behavior of complex situations where a string of Gateways are used and parallel flow is required. In addition, some modelers may wish to create a “best practice” where Parallel Gateways are always used for creating parallel paths. This practice will create an extra modeling element where one is not required, but will provide a balanced approach where forking and joining elements can be paired up.

- ◆ The Parallel Gateway MUST use a marker that is in the shape of an plus sign and is placed within the Gateway diamond (see Figure 9.28) to distinguish it from other Gateways.

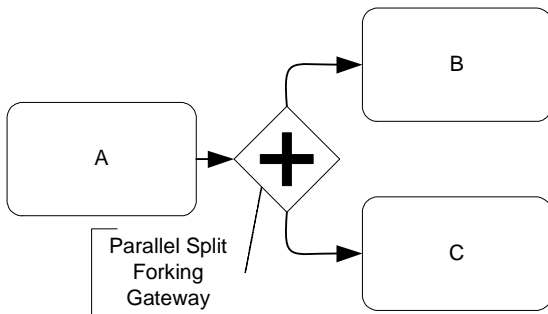

Figure 9.28 - A Parallel Gateway

Parallel Gateways are used for synchronizing parallel flow.

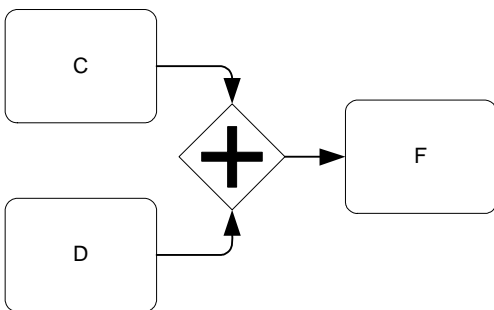

Figure 9.29 - Joining – the joining of parallel paths

Attributes

The following table displays the attributes for a Parallel Gateway. These attributes only apply if the GatewayType attribute is set to AND (Parallel). The following attributes extend the set of common Gateway attributes (see Table 9.31):

Table 9.30 - Parallel Gateway Attributes

| Attributes | Description |
|--|---|
| Gates (0-n) : Gate | There MAY be zero or more Gates. Zero Gates are allowed if the Gateway is last object in a Process flow and there are no Start or End Events for the Process. If there are zero or only one incoming Sequence Flow (i.e, the Gateway is acting as a fork), then there MUST be at least two Gates. |
| [Gate] OutgoingSequenceFlow : SequenceFlow | Each Gate MUST have an associated Sequence Flow. The Sequence Flow MUST have its Condition attribute set to None. The attributes of a Sequence Flow can be found in Section 10.1.2, “Sequence Flow,” on page 100. |
| [Gate] Assignments (0-n) : Assignment | One or more assignment expressions MAYs be made for each Gate. The Assignment SHALL be performed when the Gate is selected. The details of Assignment is defined in Section B.11.1, “Assignment,” on page 268. |

Sequence Flow Connections

This section extends the basic Gateway Sequence Flow connection rules as defined in “Common Gateway Sequence Flow Connections” on page 70. See Section 8.4.1, “Sequence Flow Rules,” on page 27 for the entire set of objects and how they may be source or targets of Sequence Flow.

To define the parallel nature of this Gateway’s behavior for converging Sequence Flow:

- ◆ If there are multiple incoming Sequence Flow, all of them will be used to continue the flow of the Process--the flow will be synchronized. That is,
 - ◆ Process flow SHALL continue when a signal (a Token) has arrived from all of a set of Sequence Flow (i.e., the process will wait for all signals to arrive before it can continue).

Note – Incoming Sequence Flow that have a source that is a downstream activity (that is, is part of a loop) will be treated differently than those that have an upstream source. They will be considered as part of a different set of Sequence Flow from those Sequence Flow that have a source that is an upstream activity.

To define the parallel nature of this Gateway’s behavior for diverging Sequence Flow:

- ◆ All Gates SHALL be selected during performance of the Process.

9.6 Swimlanes (Pools and Lanes)

BPMN has a larger scope than BPEL4WS, and this scope is expressed in different dimensions. The dimension discussed in this section has to do with defining business processes in a collaborative B2B environment. BPMN uses the concept known as “swimlanes” to help partition and/organize activities.

BPEL4WS is focused on a specific private process that is internal to a given Participant (i.e., a company or organization). BPEL4WS also can define an abstract process, but from the point of view of a single participant. It is possible that a BPMN Diagram may depict more than one private process, as well as the processes that show the collaboration between

private processes or Participants. If so, then each private business process will be considered as being performed by different Participants. Graphically, each Participant will be partitioned; that is, will be contained within a rectangular box call a “Pool.” Pools can have sub-Swimlanes that are called, simply, “Lanes.”

Section 7.1.1, “Uses of BPMN,” on page 10 describes the uses of BPMN for modeling private processes and the interactions of processes in B2B scenarios. Pools and Lanes are designed to support these uses of BPMN.

9.6.1 Common Swimlane Attributes

The following table displays a set of common attributes for Swimlanes (Pools and Lanes), and which extends the set of common graphical object attributes (see Table 9.1):

Table 9.31 - Common Swimlane Attributes

| Attributes | Description |
|----------------------|--|
| Name : String | Name is an attribute that is text description of the Swimlane. |

Changes Since 1.0 Draft Version

These are the changes since the last publicly released version:

- The set of common Swimlane attributes was added.

9.6.2 Pool

A Pool represents a Participant in the Process. A Participant can be a specific business entity (e.g, a company) or can be a more general business role (e.g., a buyer, seller, or manufacturer). Graphically, a Pool is a container for partitioning a Process from other Pools, when modeling business-to-business situations, although a Pool need not have any internal details (i.e., it can be a “black box”).

- ◆ A Pool is a square-cornered rectangle that **MUST** be drawn with a solid single black line (as seen in Figure 9.30).
- ◆ The use of text, color, size, and lines for a Pool **MUST** follow the rules defined in Section 8.3, “Use of Text, Color, Size, and Lines in a Diagram,” on page 26.

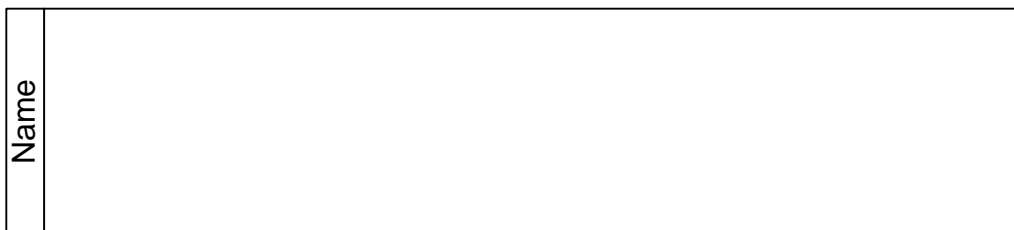

Figure 9.30 - A Pool

To help with the clarity of the Diagram, A Pool will extend the entire length of the Diagram, either horizontally or vertically. However, there is no specific restriction to the size and/or positioning of a Pool. Modelers and modeling tools can use Pools (and Lanes) in a flexible manner in the interest of conserving the “real estate” of a Diagram on a screen or a printed page.

A Pool acts as the container for the Sequence Flow between activities. The Sequence Flow can cross the boundaries between Lanes of a Pool, but cannot cross the boundaries of a Pool. The interaction between Pools, e.g., in a B2B context, is shown through Message Flow.

Another aspect of Pools is whether or not there is any activity detailed within the Pool. Thus, a given Pool may be shown as a “White Box,” with all details exposed, or as a “Black Box,” with all details hidden. No Sequence Flow is associated with a “Black Box” Pool, but Message Flow can attach to its boundaries (see Table 9.32).

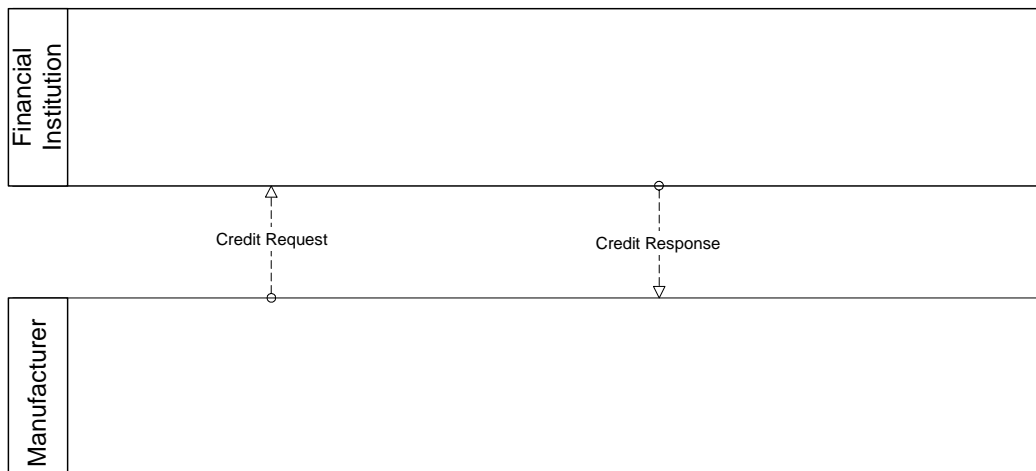

Table 9.32 - Message Flow connecting to the boundaries of two Pools

For a “White Box” Pool, the activities within are organized by Sequence Flow. Message Flow can cross the Pool boundary to attach to the appropriate activity (see Figure 9.31).

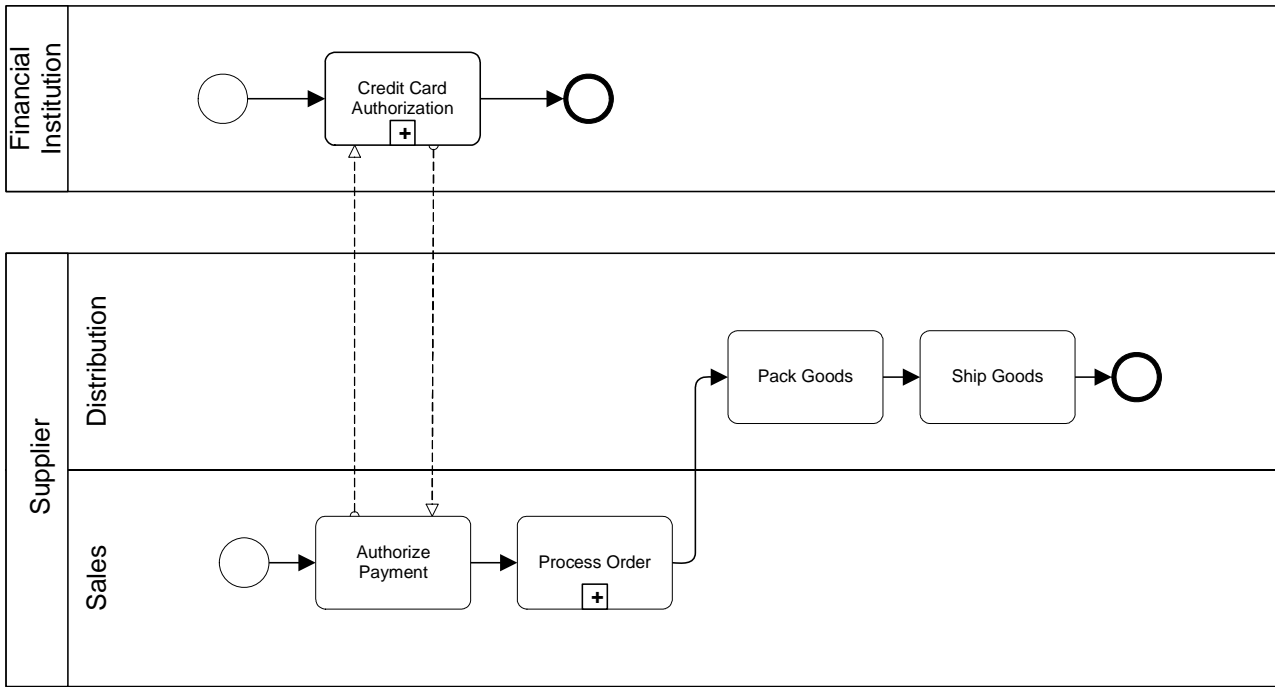

Figure 9.31 - Message Flow connecting to Flow Objects within two Pools

All BPDs contain at least one Pool. In most cases, a BPD that consists of a single Pool will only display the activities of the Process and not display the boundaries of the Pool. Furthermore, many BPDs may show the “main” Pool without boundaries. That is, the activities that represent the work performed from the point of view of the modeler or the modeler’s organization are considered “internal” activities and may not be surrounded by the boundaries of a Pool, while the other Pools in the Diagram will have their boundary. (see Figure 9.32)

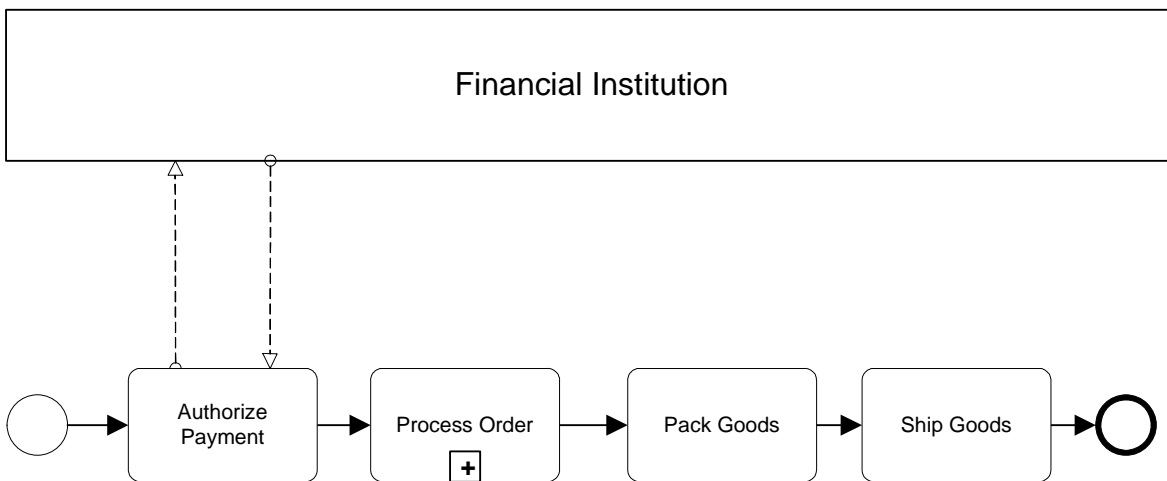

Figure 9.32 - Main (Internal) Pool without boundaries

Attributes

The following table displays the identified attributes of a Pool, and which extends the set of common Swimlane attributes (see Table 9.34):

Table 9.33 - Pool Attributes

| Attributes | Description |
|---------------------------------------|---|
| Process (0-1) : Process | The Process attribute defines the Process that is contained within the Pool. Each Pool MAY have a Process. The attributes for a Process can be found in Section 8.6, “Processes,” on page 29. |
| Participant : Participant | The Modeler MUST define the Participant for a Pool. The Participant can be either a Role or an Entity. This defines the role that a particular Entity or Role the Pool will play in a Diagram that includes collaboration. The attributes for a Participant can be found in Section B.11.6, “Participant,” on page 270. |
| Lanes (1-n) : Lane | There MUST be one or more Lanes within a Pool. If there is only one Lane, then that Lane shares the name of the Pool and only the Pool name is displayed. If there is more than one Lane, then each Lane has to have its own name and all names are displayed. The attributes for a Lane can be found in Section 9.6.3, “Lane,” on page 90. |
| BoundaryVisible True : Boolean | This attribute defines if the rectangular boundary for the Pool is visible. Only one Pool in the Diagram MAY have the attribute set to False. |

Changes Since 1.0 Draft Version

These are the changes since the last publicly released version:

- The constraint about the fill of the Pool was removed.
- The Process attribute were added to the set of Pool attributes.
- The PoolType attribute was removed from the set of Pool attributes.
- The Id and Documentation attributes was moved to the set of common graphical object attributes.
- The Name attribute was moved to the set of common Swimlane attributes.
- The Owner attributes, within the set of Pool attributes, was renamed to be Participant and of type Role or Entity. Also, the attribute was changed from optional to mandatory.
- The Lane attribute, within the set of Pool attributes, was renamed to Lanes and changed to be of type Lane.

9.6.3 Lane

A Lane is a sub-partition within a Pool and will extend the entire length of the Pool, either vertically or horizontally (see Figure 9.33). Text associated with the Lane (e.g., its name and/or any attribute) can be placed inside the shape, in any direction or location, depending on the preference of the modeler or modeling tool vendor. Our examples place the name as a banner on the left side (for horizontal Pools) or at the top (for vertical Pools) on the other side of the line that separates the Pool name, however, this is not a requirement.



Figure 9.33 - Two Lanes in a Pool

Lanes are used to organize and categorize activities within a Pool. The meaning of the Lanes is up to the modeler. BPMN does not specify the usage of Lanes. Lanes are often used for such things as internal roles (e.g., Manager, Associate), systems (e.g., an enterprise application), an internal department (e.g., shipping, finance), etc. In addition, Lanes can be nested or defined in a matrix. For example, there could be an outer set of Lanes for company departments and then an inner set of Lanes for roles within each department.

Attributes

The following table displays the identified attributes of a Lane, and which extends the set of common Swimlane attributes (see Table 9.37):

Table 9.34 - Lane Attributes

| Attributes | Description |
|--------------------------------|---|
| ParentPool : Pool | The Parent Pool MUST be specified. There can be only one Parent. The attributes for a Pool can be found in Section 9.6.2, “Pool,” on page 87. |
| ParentLane (0-1) : Lane | ParentLane is an optional attribute that is used if the Lane is nested within another Lane. Nesting can be multi-level, but only the immediate parent is specified. |

Changes Since 1.0 Draft Version

These are the changes since the last publicly released version:

- The ParentPool attribute, within the set of Lane attributes, was change to be of type Pool.
- The ParentLane attribute, within the set of Lane attributes, was change to be of type Lane.
- The Id and Documentation attributes was moved to the set of common graphical object attributes.
- The Name attribute was moved to the set of common Swimlane attributes.

9.7 Artifacts

BPMN provides modelers with the capability of showing additional information about a Process that is not directly related to the Sequence Flow or Message Flow of the Process.

At this point, BPMN provides three standard Artifacts: A Data Object, a Group, and an Annotation. Additional standard Artifacts may be added to the BPMN specification in later versions. A modeler or modeling tool may extend a BPD and add new types of Artifacts to a Diagram. Any new Artifact must follow the Sequence Flow and Message Flow connection rules (listed below). Associations can be used to link Artifacts to Flow Objects (see Section 10.1.4, “Association,” on page 105).

9.7.1 Common Artifact Definitions

The following sections provide definitions that are common to all Artifacts.

Common Artifact Attributes

The following table displays the identified attributes common to Artifacts, and which extends the set of common graphical object attributes (see Table 9.1):

Table 9.35 - Common Artifact Attributes

| Attributes | Description |
|---|--|
| ArtifactType (DataObject Group Annotation) DataObject : String | The ArtifactType MAY be set to DataObject, Group, or Annotation. The ArtifactType list MAY be extended to include new types. |
| Pool (0-1) : Pool | A Pool MAY be added to identify its location. Artifacts, such as Annotations, can be placed outside of any Pool. Also, a Group may stretch across multiple Pools. The attributes for a Pool can be found in the Section 9.6.2, “Pool,” on page 87. |
| Lanes (0-n) : Lane | If the Pool has been specified and it has more than one Lane, then a LaneName MUST be added. There MAY be multiple Lanes listed. The attributes for a Lane can be found in the Section 9.6.3, “Lane,” on page 90. |

Artifact Sequence Flow Connections

See Section 8.4.1, “Sequence Flow Rules,” on page 27 for the entire set of objects and how they may be source or targets of Sequence Flow.

- ◆ An Artifact MUST NOT be a target for Sequence Flow.
- ◆ An Artifact MUST NOT be a source for Sequence Flow.

Artifact Message Flow Connections

See Section 8.4.2, “Message Flow Rules,” on page 28 for the entire set of objects and how they may be source or targets of Message Flow.

- ◆ An Artifact MUST NOT be a target for Message Flow.
- ◆ An Artifact MUST NOT be a source for Message Flow.

Changes Since 1.0 Draft Version

These are the changes since the last publicly released version:

- The Name attribute was removed from the set of common Artifact attributes.

- The Id and Documentation attributes was moved to the set of common graphical object attributes.
- The Pool and Lanes attributes were added to the set of common Artifact attributes.

9.7.2 Data Object

In BPMN, a Data Object is considered an Artifact and not a Flow Object. They are considered an Artifact because they do not have any direct affect on the Sequence Flow or Message Flow of the Process, but they do provide information about what the Process does. That is, how documents, data, and other objects are used and updated during the Process. While the name “Data Object” may imply an electronic document, they can be used to represent many different types of objects, both electronic and physical.

In general, BPMN will not standardize many modeling Artifacts. These will mainly be up to modelers and modeling tool vendors to create for their own purposes. However, equivalents of the BPMN Data Object are used by Document Management oriented workflow systems and many other process modeling methodologies. Thus, this object is used enough that it is important to standardize its shape and behavior.

- ◆ A Data Object is a portrait-oriented rectangle that has its upper-right corner folded over that MUST be drawn with a solid single black line (as seen in Figure 9.34).
- ◆ The use of text, color, size, and lines for a Data Object MUST follow the rules defined in Section 8.3, “Use of Text, Color, Size, and Lines in a Diagram,” on page 26.



Figure 9.34 - A Data Object

As an Artifact, Data Objects generally will be associated with Flow Objects. An Association will be used to make the connection between the Data Object and the Flow Object. This means that the behavior of the Process can be modeled without Data Objects for modelers who want to reduce clutter. The same Process can be modeled with Data Objects for modelers who want to include more information without changing the basic behavior of the Process.

In some cases, the Data Object will be shown being sent from one activity to another, via a Sequence Flow (see Figure 9.35). Data Objects will also be associated with Message Flow. They are not to be confused with the message itself, but could be thought of as the “payload” or content of some messages.

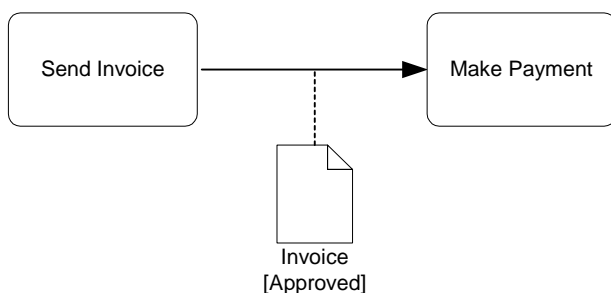

Figure 9.35 - A Data Object associated with a Sequence Flow

In other cases, the same Data Object will be shown as being an input, then an output of a Process (see Figure 9.36). Directionality added to the Association will show whether the Data Object is an input or an output. Also, the state attribute of the Data Object can change to show the impact of the Process on the Data Object.

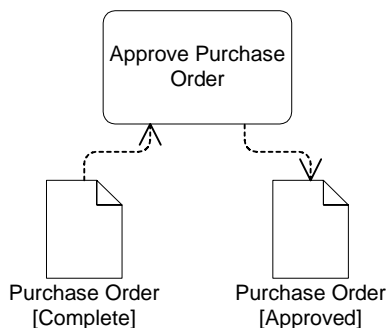

Figure 9.36 - Data Objects shown as inputs and outputs

Attributes

The following table displays the attributes for Data Objects, which extends the set of common Artifact attributes (see). These attributes only apply if the ArtifactType attribute is set to DataObject:

Table 9.36 - Data Object Attributes

| Attributes | Description |
|--|---|
| Name : String | Name is an attribute that is text description of the object. |
| State (0-1) : String | State is an optional attribute that indicates the impact the Process has had on the Data Object. Multiple Data Objects with the same name MAY share the same state within one Process. |
| Properties (0-n) : Property | Modeler-defined Properties MAY be added to a Data Object. The fully delineated name of these properties is “<process name>.<task name>.<property name>” (e.g., “Add Customer.Credit Report.Score”). Further details about the definition of a Property can be found in Section B.11.7, “Property,” on page 270. |
| RequiredForStart True : Boolean | The default value for this attribute is True. This means that the Input is required for an activity to start. If set to False, then the activity MAY start within the input, but MAY accept the input (more than once) after the activity has started. |
| ProducedAtCompletion True : Boolean | The default value for this attribute is True. This means that the Output will be produced when an activity has been completed. If set to False, then the activity MAY produce the output (more than once) before it has completed. |

Changes Since 1.0 Draft Version

These are the changes since the last publicly released version:

- The Name attribute was added to the set of Data Object attributes.

- The Pool and Lanes attributes were removed from the set of Data Object attributes. These two attributes were added to the set of Common Artifact attributes.
- The Name and Type attributes were removed from the set of Property attributes. These attributes can be found in the definition of a Property, which can be found in Section B.11.7, “Property,” on page 270.
- The RequiredForStart and ProducedAtCompletion attributes were added to the set of Data Object attributes.
- The constraint about the fill of the Data Object was removed.

9.7.3 Text Annotation

Text Annotations are a mechanism for a modeler to provide additional information for the reader of a BPMN Diagram.

- ◆ A Text Annotation is an open rectangle that **MUST** be drawn with a solid single black line (as seen in Figure 9.37).
 - ◆ The use of text, color, size, and lines for a Text Annotation **MUST** follow the rules defined in Section 8.3, “Use of Text, Color, Size, and Lines in a Diagram,” on page 26.

The Text Annotation object can be connected to a specific object on the Diagram with an Association (see Figure 9.37), but do not affect the flow of the Process. Text associated with the Annotation can be placed within the bounds of the open rectangle.

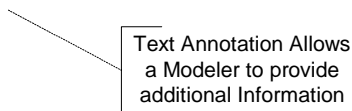

Figure 9.37 - A Text Annotation

Attributes

The following table displays the attributes for Annotations, which extends the set of common Artifact attributes (see). These attributes only apply if the ArtifactType attribute is set to Annotation:

Table 9.37 - Text Annotation Attributes

| Attributes | Description |
|----------------------|--|
| Text : String | Text is an attribute that is text that the modeler wishes to communicate to the reader of the Diagram. |

Changes Since 1.0 Draft Version

These are the changes since the last publicly released version:

- The constraint about the fill of the Text Annotation was removed.

9.7.4 Group

The Group object is an Artifact that provides a visual mechanism to group elements of a Process informally.

- ◆ A Group is a rounded corner rectangle that **MUST** be drawn with a solid dashed black line (as seen in Figure 9.38).
 - ◆ The use of text, color, size, and lines for a Group **MUST** follow the rules defined in Section 8.3, “Use of Text,

Color, Size, and Lines in a Diagram,” on page 26.



Figure 9.38 - A Group Artifact

As an Artifact, a Group is not an activity or any Flow Object, and, therefore, cannot connect to Sequence Flow or Message Flow. In addition, Groups are not constrained by restrictions of Pools and Lanes. This means that a Group can stretch across the boundaries of a Pool to surround Diagram elements (see Figure 9.39), often to identify activities that exist within a distributed business-to-business transaction.

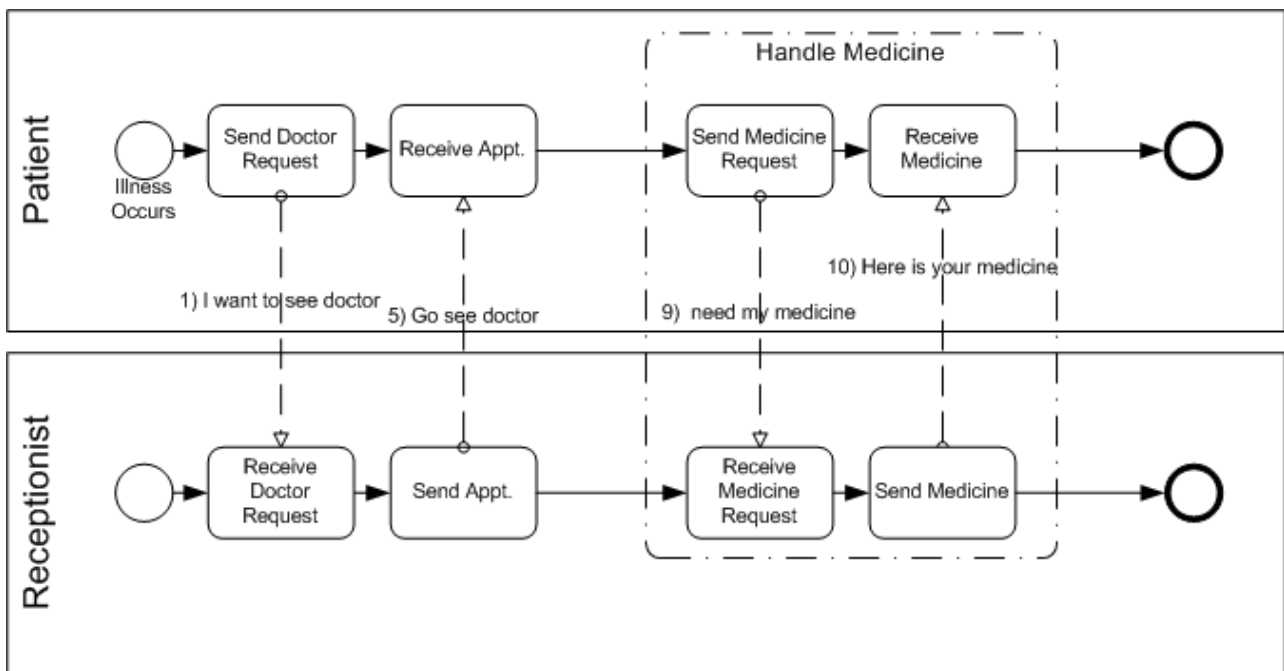

Figure 9.39 - A Group around activities in different Pools

Groups are often used to highlight certain sections of a Diagram without adding additional constraints for performance-- as a Sub-Process would. The highlighted (grouped) section of the Diagram can be separated for reporting and analysis purposes. Groups do not affect the flow of the Process and do not map to any BPEL4WS elements.

The following table displays the attributes for Groups, and which extends the set of common Artifact attributes. These attributes only apply if the ArtifactType attribute is set to Group:

Table 9.38 - Group Attributes

| Attributes | Description |
|---------------------|--|
| Name (0-1) : String | Name is an optional attribute that is text description of the Group. |

Changes Since 1.0 Draft Version

These are the changes since the last publicly released version:

- The Name attribute was added to the set of Group attributes.
- The constraint about the fill of the Group was removed.

10 Business Process Diagram Connecting Objects

This section defines the graphical objects used to connect two objects together (i.e., the connecting lines of the Diagram) and how the flow progresses through a Process (i.e., through a straight sequence or through the creation of parallel or alternative paths).

10.1 Graphical Connecting Objects

There are two ways of Connecting Objects in BPMN: a Flow, either sequence or message, and an Association. Sequence Flow and Message Flow, to a certain extent, represent orthogonal aspects of the business processes depicted in a model, although they both affect the performance of activities within a Process. In keeping with this, Sequence Flow will generally flow in a single direction (either left to right, or top to bottom) and Message Flow will flow at a 90° from the Sequence Flow. This will help clarify the relationships for a Diagram that contains both Sequence Flow and Message Flow. However, BPMN does not restrict this relationship between the two types of Flow. A modeler can connect either type of Flow in any direction at any place in the Diagram.

The next three sections will describe how these types of connections function in BPMN.

10.1.1 Common Connecting Object Attributes

The following table displays the set of attributes common to Connecting Objects (Sequence Flow, Message Flow, and Association), and which extends the set of common graphical object attributes (see Table 9.1):

Table 10.1 - Common Connecting Object Attributes

| Attributes | Description |
|----------------------------|---|
| Name (0-1) : String | Name is an optional attribute that is text description of the Connecting Object. |
| Source : Object | Source is an attribute that identifies which Flow Object the Connecting Object is connected <i>from</i> . Note: there are restrictions as to what objects Sequence Flow and Message Flow can connect. Refer to the Sequence Flow Connections section and the Message Flow Connections section for each Flow Object, Swimlane, and Artifact. |
| Target : Object | Target is an attribute that identifies which Flow Object the Connecting Object is connected <i>to</i> . Note: there are restrictions as to what objects Sequence Flow and Message Flow can connect. Refer to the Sequence Flow Connections section and the Message Flow Connections section for each Flow Object, Swimlane, and Artifact. |

Changes Since 1.0 Draft Version

These are the changes since the last publicly released version:

- The set of common set of Connecting Object attributes was added.
- The Source and Target attributes, within the set of common Connecting Object attributes, were changed to the type Object.

10.1.2 Sequence Flow

A Sequence Flow is used to show the order that activities will be performed in a Process. Each Flow has only one source and only one target. The source and target must be from the set of the following Flow Objects: Events (Start, Intermediate, and End), Activities (Task and Sub-Process), and Gateways. During performance (or simulation) of the process, a Token will leave the source Flow Object, traverse down the Sequence Flow, and enter the target Flow Object.

- ◆ A Sequence Flow is line with a solid arrowhead that **MUST** be drawn with a solid single line (as seen in Figure 10.1).
- ◆ The use of text, color, and size for Sequence Flow **MUST** follow the rules defined in Section 8.3, “Use of Text, Color, Size, and Lines in a Diagram,” on page 26.

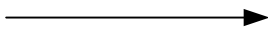

Figure 10.1 - A Sequence Flow

BPMN does not use the term “Control Flow” when referring the lines represented by Sequence Flow or Message Flow. The start of an activity is “controlled” not only by Sequence Flow (the order of activities), but also by Message Flow (a message arriving), as well as other process factors, such as scheduled resources. Artifacts can be Associated with activities to show some of these other factors. Thus, we are using a more specific term, “Sequence Flow,” since these lines mainly illustrate the sequence that activities will be performed.

- ◆ A Sequence Flow **MAY** have a conditional expression attribute, depending on its source object.

This means that the condition expression must be evaluated before a Token can be generated and then leave the source object to traverse the Flow. The conditions are usually associated with Decision Gateways, but can also be used with activities.

- ◆ If the source of the Sequence Flow is an activity, rather than Gateway, then a Conditional Marker, shaped as a “mini-diamond,” **MUST** be used at the beginning of the Sequence Flow (see Figure 10.2).

The diamond shape is used to relate the behavior to a Gateway (also a diamond) that controls the flow within a Process. More information about how conditional Sequence Flow are used can be found in “Splitting Flow” on page 115.

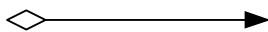

Figure 10.2 - A Conditional Sequence Flow

A Sequence Flow that has an Exclusive Data-Based Gateway or an activity as its source can also be defined with a condition expression of Default. Such Sequence Flow will have a marker to show that it is a Default flow.

- ◆ The Default Marker **MUST** be a backslash near the beginning of the line (see Figure 10.3).

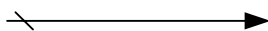

Figure 10.3 - A Default Sequence Flow

Attributes

The following table displays the set of attributes of a Sequence Flow, and which extends the set of common Connecting Object attributes (see Figure 10.44):

Table 10.2 - Sequence Flow Attributes

| Attributes | Description |
|---|---|
| <p>ConditionType (None Expression Default) None : String</p> | <p>By default, the ConditionType of a Sequence Flow is None. This means that there is no evaluation at runtime to determine whether or not the Sequence Flow will be used. Once a Token is ready to traverse the Sequence Flow (i.e., the Source is an activity that has completed), then the Token will do so. The normal, uncontrolled use of Sequence Flow, in a sequence of activities, will have a None ConditionType (see Figure 10.12). A None ConditionType MUST NOT be used if the Source of the Sequence Flow is an Exclusive Data-Based or Inclusive Gateway.</p> <p>The ConditionType attribute MAY be set to Expression if the Source of the Sequence Flow is a Task, a Sub-Process, or a Gateway of type Exclusive-Data-Based or Inclusive.</p> <p>If the ConditionType attribute is set to Expression, then a condition marker SHALL be added to the line if the Sequence Flow is outgoing from an activity (see Figure 10.2). However, a condition indicator MUST NOT be added to the line if the Sequence Flow is outgoing from a Gateway.</p> <p>An Expression ConditionType MUST NOT be used if the Source of the Sequence Flow is an Event-Based Exclusive Gateway, a Complex Gateway, a Parallel Gateway, a Start Event, or an Intermediate Event. In addition, an Expression ConditionType MUST NOT be used if the Sequence Flow is associated with the Default Gate of a Gateway.</p> <p>The ConditionType attribute MAY be set to Default only if the Source of the Sequence Flow is an activity or an Exclusive Data-Based Gateway. If the ConditionType is Default, then the Default marker SHALL be displayed (see Figure 10.3).</p> |
| <p>[ConditionType is set to Expression only] ConditionExpression: Expression</p> | <p>If the ConditionType attribute is set to Expression, then the ConditionExpression attribute MUST be defined as a valid expression. The expression will be evaluated at runtime. If the result of the evaluation is TRUE, then a Token will be generated and will traverse the Sequence--Subject to any constraints imposed by a Source that is a Gateway.</p> |
| <p>Quantity 1 : Integer</p> | <p>The default value is 1. The value MUST NOT be less than 1. This attribute defines the number of Tokens that will be generated down the Sequence Flow.</p> |

Changes Since 1.0 Draft Version

These are the changes since the last publicly released version:

- The Id and Documentation attributes were moved to the set of common graphical object attributes.
- The Name, Source, and Target attributes were moved to the set of common Connecting Object attributes.
- The Condition attribute, within the set of Sequence Flow attributes, was renamed to ConditionType.

- The Quantity attribute was added to the set of Sequence Flow attributes.

10.1.3 Message Flow

A Message Flow is used to show the flow of messages between two entities that are prepared to send and receive them. In BPMN, two separate Pools in the Diagram will represent the two entities. Thus,

- ◆ Message Flow MUST connect two Pools, either to the Pools themselves or to Flow Objects within the Pools. They cannot connect two objects within the same Pool.
- ◆ A Message Flow is line with a open arrowhead that MUST be drawn with a dashed single black line (as seen in Figure 10.4).
- ◆ The use of text, color, size, and lines for Message Flow MUST follow the rules defined in Section 8.3, “Use of Text, Color, Size, and Lines in a Diagram,” on page 26.

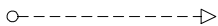

Figure 10.4 - A Message Flow

The Message Flow can connect directly to the boundary of a Pool (See Figure 10.5), especially if the Pool does not have any process details within (e.g., is a “Black Box”).

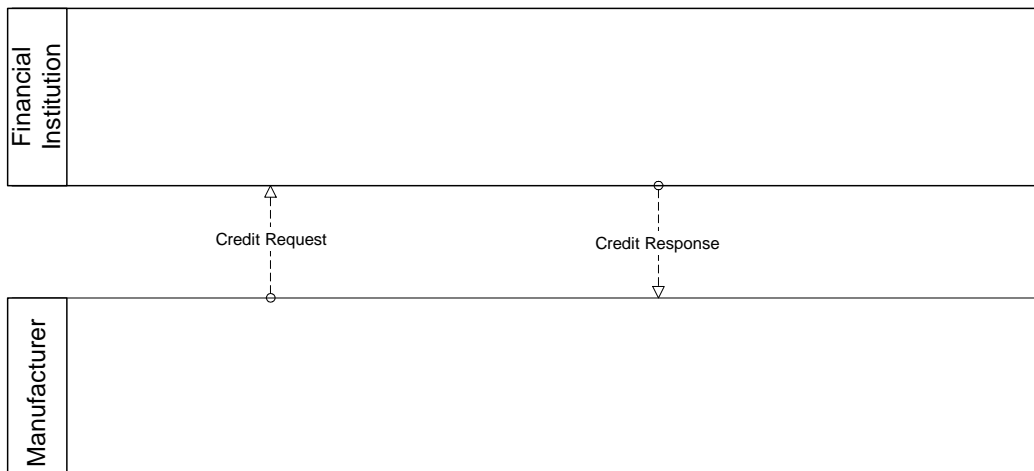

Figure 10.5 - Message Flow connecting to the boundaries of two Pools

A Message Flow can also cross the boundary of a Pool and connect to a Flow Object within that Pool (see Figure 10.6).

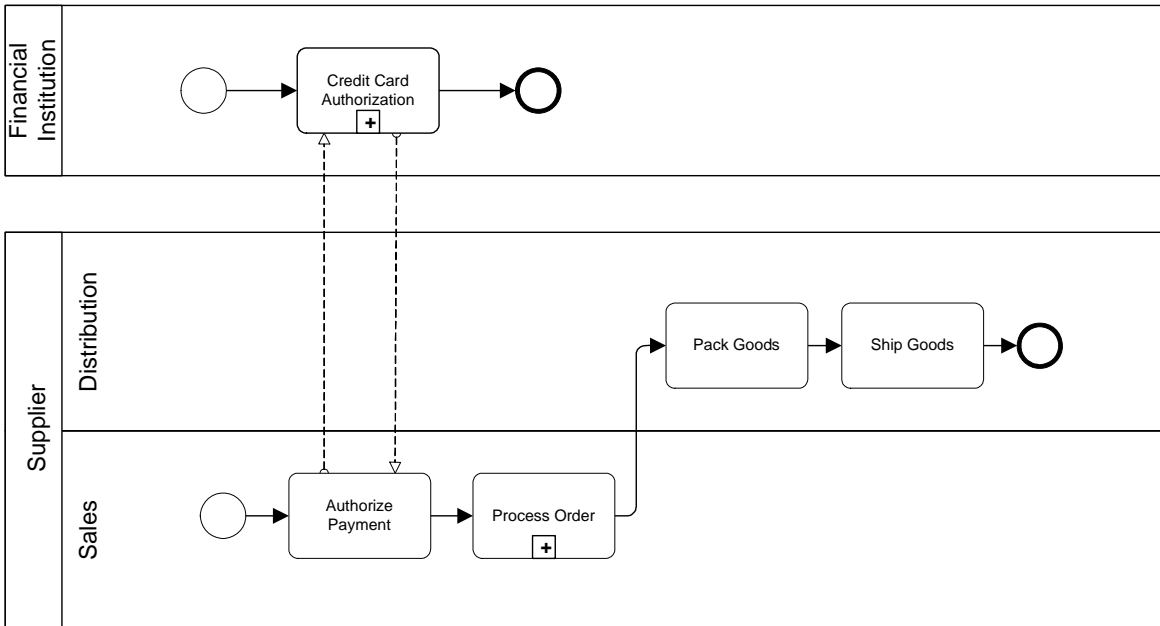

Figure 10.6 - Message Flow connecting to Flow Objects within two Pools

If there is an Expanded Sub-Process in one of the Pools, then the message flow can be connected to either the boundary of the Sub-Process or to objects within the Sub-Process. If the Message Flow is connected to the boundary to the Expanded Sub-Process, then this is equivalent to connecting to the Start Event for incoming Message Flow or the End Event for outgoing Message Flow (see Figure 10.7).

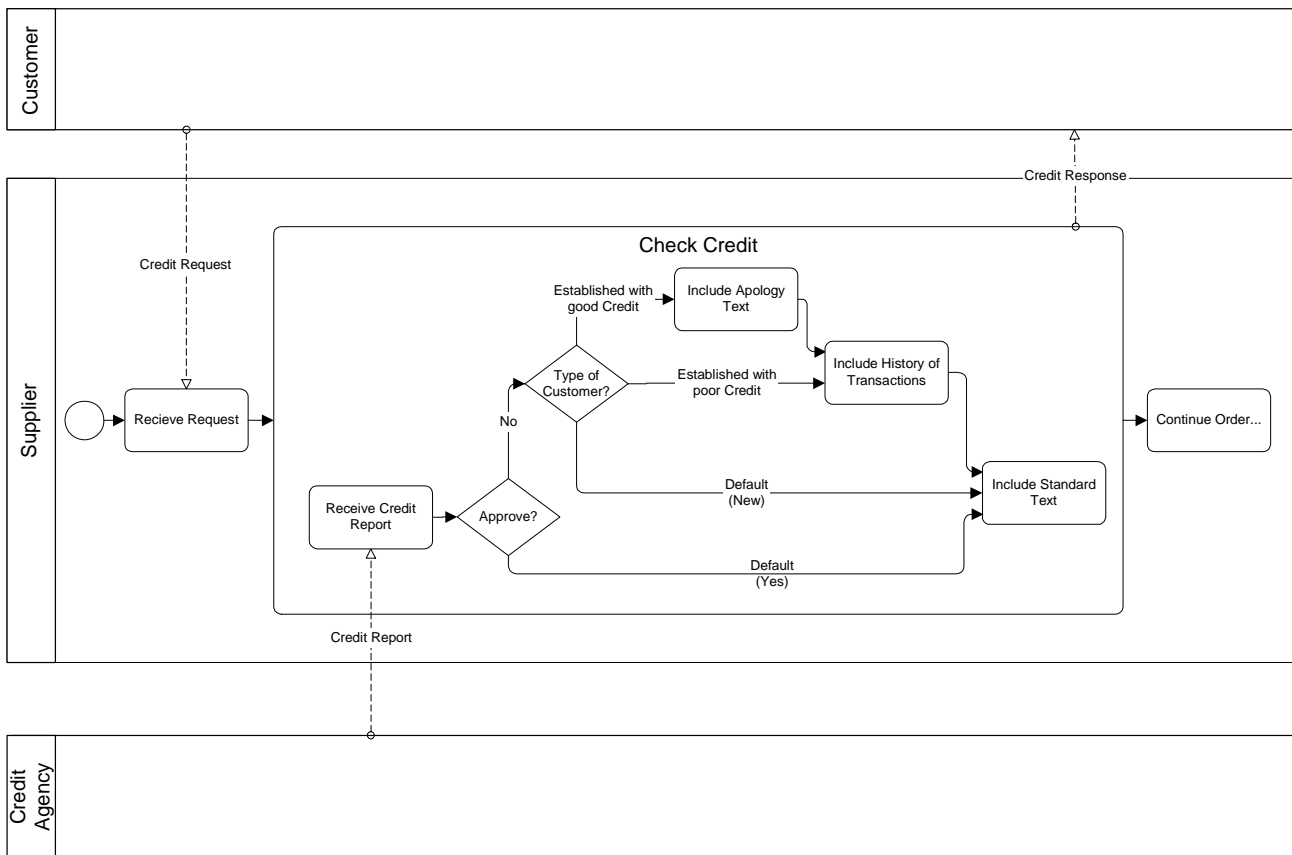

Figure 10.7 - Message Flow connecting to boundary of Sub-Process and Internal objects

Attributes

The following table displays the identified attributes of a Message Flow, and which extends the set of common Connecting Object attributes (see Table 10.1):

Table 10.3 - Message Flow Attributes

| Attributes | Description |
|--------------------------------|--|
| Message (0-1) : Message | Message is an optional attribute that identifies the Message that is being sent. The attributes of a Message can be found in Section B.11.4, “Message,” on page 269. |

Changes Since 1.0 Draft Version

These are the changes since the last publicly released version:

- The Id and Documentation attributes were moved to the set of common graphical object attributes.
- The Name, Source, and Target attributes were moved to the set of common Connecting Object attributes.
- The Message and Categories attributes were added to the set of Message Flow attributes.

10.1.4 Association

An Association is used to associate information and Artifacts with Flow Objects. Text and graphical non-Flow Objects can be associated with the Flow Objects and Flow. An Association is also used to show the activities used to compensate for an activity. More information about compensation can be found in Section 10.3, “Compensation Association,” on page 133.

- ◆ An Association Flow is line that **MUST** be drawn with a dotted single black line (as seen in Figure 10.8).
- ◆ The use of text, color, size, and lines for an Association **MUST** follow the rules defined in Section 8.3, “Use of Text, Color, Size, and Lines in a Diagram,” on page 26.

Figure 10.8 - An Association

If there is a reason to put directionality on the association then:

- ◆ A line arrowhead **MAY** be added to the Association line. (see Figure 10.9).

A directional Association is often used with Data Objects to show that a Data Object is either an input to or an output from an activity.

----->

Figure 10.9 - A directional Association

An Association is used to connect user-defined text (an Annotation) with a Flow Object (see Figure 10.10).

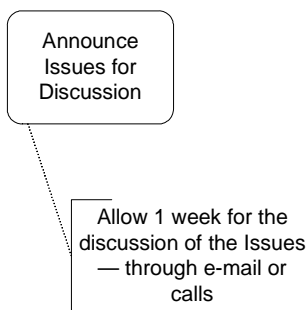

Figure 10.10 - An Association of Text Annotation

An Association is also used to associate Data Objects with other objects (see Figure 10.11). A Data Object is used to show how documents are used throughout a Process. See Section 9.7.2, “Data Object,” on page 93 for more information on Data Objects.

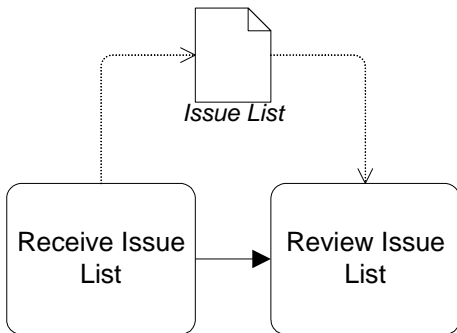

Figure 10.11 - An Association connecting a Data Object with a Flow

Attributes

The following table displays the identified attributes of a Association, and which extends the set of common Connecting Object attributes (see Table 10.1):

Table 10.4 - Association Attributes

| Attributes | Description |
|--|--|
| Direction (None To From Both) None : String | Direction is an attribute that defines whether or not the Association shows any directionality with an arrowhead. The default is None (no arrowhead). A value of To means that the arrowhead SHALL be at the Source object. A value of From means that the arrowhead SHALL be at the Target Artifact. A value of Both means that there SHALL be an arrowhead at both ends of the Association line. |

Changes Since 1.0 Draft Version

These are the changes since the last publicly released version:

- The Id and Documentation attributes were moved to the set of common graphical object attributes.
- The Name, Source, and Target attributes were moved to the set of common Connecting Object attributes.

10.2 Sequence Flow Mechanisms

The Sequence Flow mechanisms described in the following sections are divided into four types: Normal, Exception, Link Events, and Ad Hoc (no flow). Within these types of flow, BPMN can be related to specific “Workflow Patterns¹.” These patterns began as development work by Wil van der Aalst, Arthur ter Hofstede, Bartek Kiepuszewski, and Alistair Barros². Twenty-one patterns have been defined as a way to document specific behavior that can be executed by a BPM system. These patterns range from very simple behavior to very complex business behavior. These patterns are useful in that they provide a comprehensive checklist of behavior that should be accounted for by BPM system. Therefore, some of these patterns will be illustrated with BPMN in the following sections to show how BPMN can handle the simple and complex requirements for Business Process Modeling.

1. <http://tmitwww.tm.tue.nl/research/patterns/>
 2. <http://tmitwww.tm.tue.nl/research/patterns/download/wfs-pat-2002.pdf>

10.2.1 Normal Flow

Normal Sequence Flow refers to the flow that originates from a Start Event and continues through activities via alternative and parallel paths until it ends at an End Event. The simplest type of flow within a Process is a sequence, which defines a dependencies of order for a series of activities that will be performed (sequentially). A sequence is also Workflow Pattern #1 -- Sequence³ (see Figure 10.12).

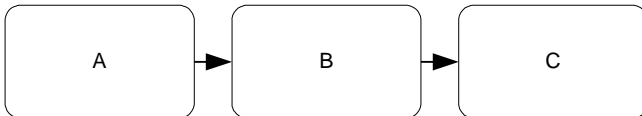

Figure 10.12 - Workflow Pattern #1: Sequence

As stated previously, the normal Sequence Flow should be completely exposed and no flow behavior hidden. This means that a viewer of a BPMN Diagram will be able to trace through a series of Flow Objects and Sequence Flow, from the beginning to the end of a given level of the Process without any gaps or hidden “jumps” (see Figure 10.13). In this figure, Sequence Flow connect all the objects in the Diagram, from the Start Event to the End Event. The behavior of the Process shown will reflect the connections as shown and not skip any activities or “jump” to the end of the Process.

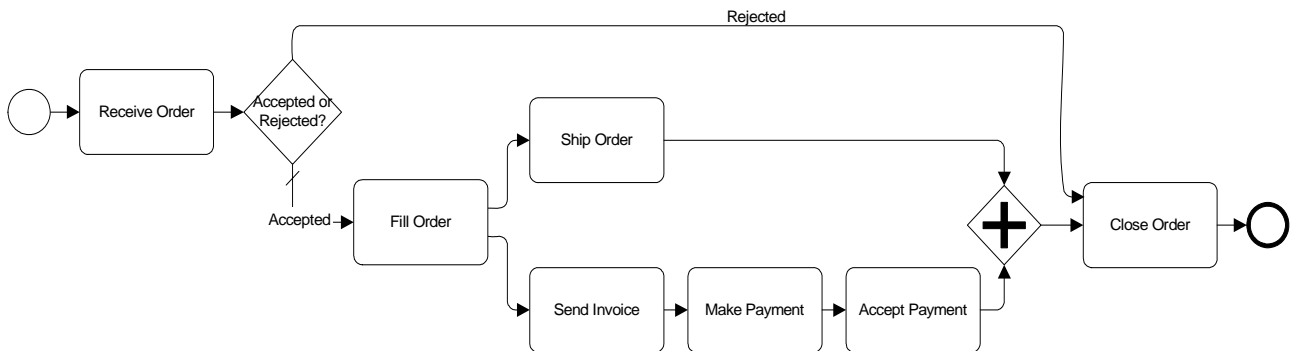

Figure 10.13 - A Process with Normal Flow

As the Process continues through the series of Sequence Flow, control mechanisms may divide or combine the Sequence Flow as a means of describing complex behavior. There are control mechanisms for dividing (forking and splitting) and for combining (joining and merging) Sequence Flow. Gateways and conditional Sequence Flow are used to accomplish the dividing and combining of flow. It is possible that there may be gaps in the Sequence Flow if Gateways and/or conditional Sequence Flow are not configured to cover all performance possibilities. In this case, a model that violates the flow traceability requirement will be considered an invalid model. Presumably, process development software or BPM test environments will be able to test a process model to ensure that the model is valid.

A casual look at the definitions of the English terms for these mechanisms (e.g., forking and splitting) would indicate that each pair of terms mean basically the same thing. However, their effect on the behavior of a Process is quite different. We will continue to use these English terms but will provide specific definitions about how they affect the performance of the

3. <http://tmitwww.tn.tue.nl/research/patterns/sequence.htm>

process in the next few sections of this specification. In addition, we will relate these BPMN terms to the terms OR-Split (for split), Or-Join (for merge), AND-Split (for fork), and AND-Join (for join), as defined by the Workflow Management Coalition.⁴

The use of an expanded Sub-Process in a Process (see Figure 10.14), which is the inclusion of one level of the Process within another Level of the Process, can sometimes break the traceability of the flow through the lines of the Diagram. The Sub-Process is not required to have a Start Event and an End Event. This means that the series of Sequence Flow will be disrupted from border of the Expanded Sub-Process to the first object within the Expanded Sub-Process. The flow will “jump” to the first object within the Expanded Sub-Process. Expanded Sub-Processes will often be used, as seen in the figure, to include exception handling. A requirement that modelers always include a Start Event and End Event within Expanded Sub-Processes would mainly add clutter to the Diagram without necessarily adding to the clarity of the Diagram. Thus, BPMN does not require the use of Start Events and End Events to satisfy the traceability of a Diagram that contains multiple levels.

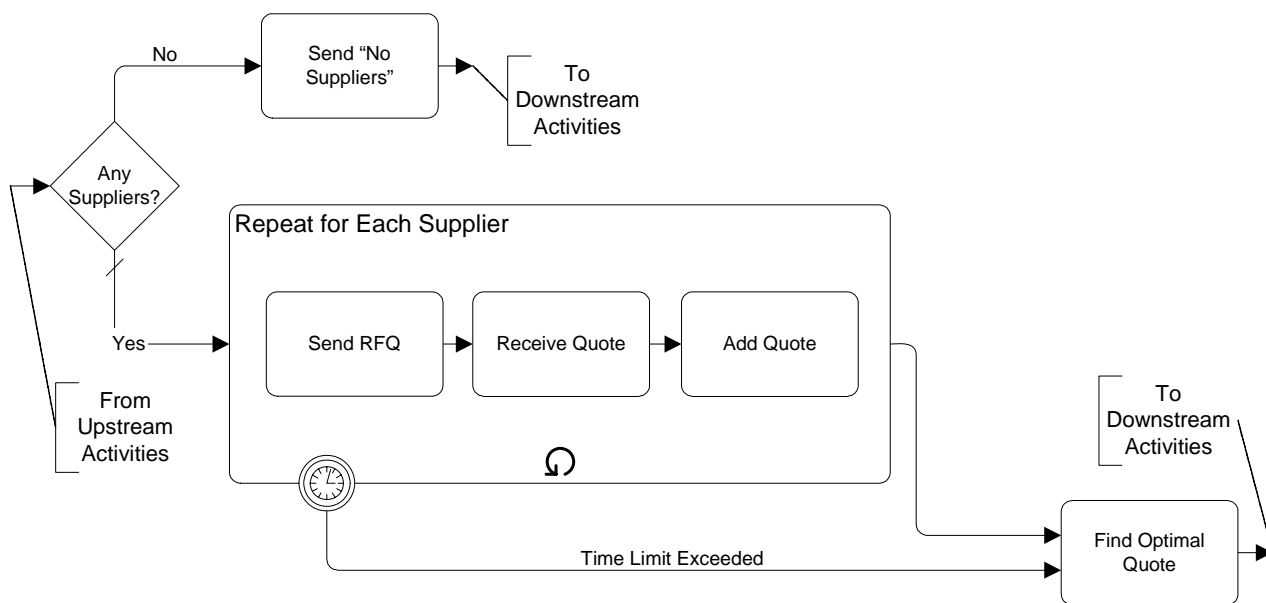

Figure 10.14 - An Expanded Sub-Process without a Start Event and End Event

Of course, the Start and End Events for an Expanded Sub-Process can be included and placed entirely within its boundaries (see Figure 10.15). This type of model will also have a break from a completely traceable Sequence Flow as the flow continues from one Process level to another.

4. *The Workflow Management Coalition Terminology & Glossary*. The Workflow Management Coalition. Document Number WFMC-TC-1011. April 1999.

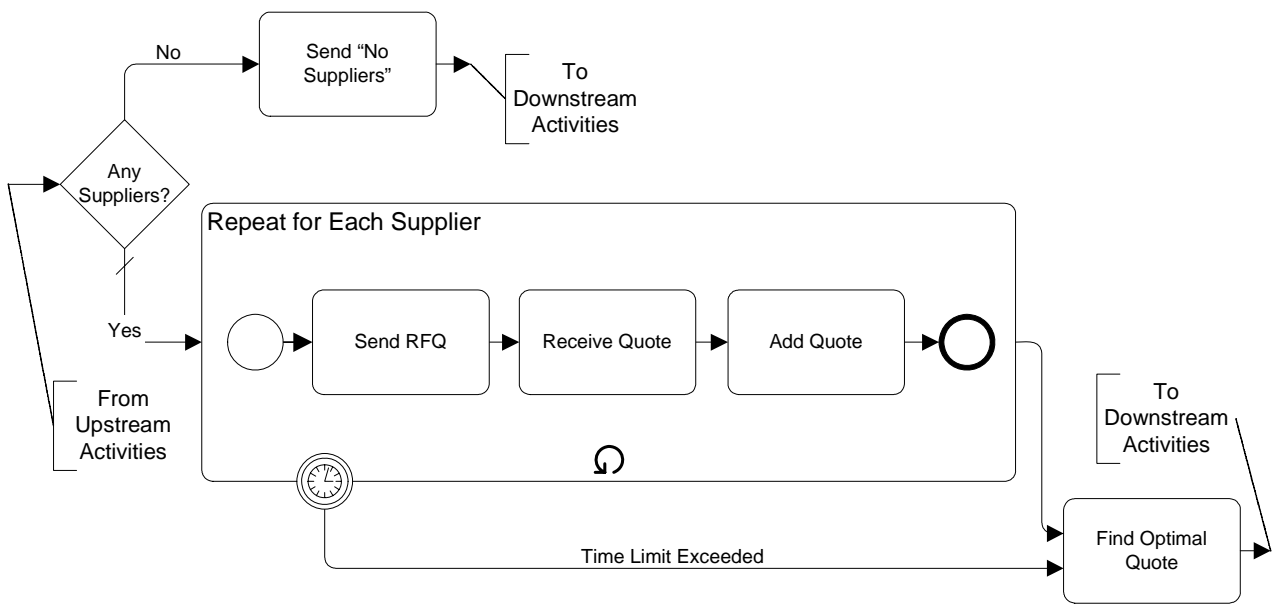

Figure 10.15 - An Expanded Sub-Process with a Start Event and End Event Internal

However, a modeler may want to ensure the traceability of a Diagram and can use a Start Event and End Event in an Expanded Sub-Process. One way to do this would be to attach these events to the boundary of the Expanded Sub-Process (see Figure 10.16). The incoming Sequence Flow to the Sub-Process can be attached directly to the Start Event instead of the boundary of the Sub-Process. Likewise, the outgoing Sequence Flow from the Sub-Process can connect from the End Event instead of the boundary of the Sub-Process. Doing this, the Normal Flow can be traced throughout a multi-level Process.

Technically, the Start and End Events still reside within the Sub-Process. The use of this modeling technic is just a graphical short-cut to a more accurate depiction of the Process (i.e., as shown in Figure 10.15). Therefore, the Sequence Flow connecting to the Start Event and connecting from the End Event do not violate the Sequence Flow connection rules (as defined in “Sequence Flow Connections” on page 38 and “Sequence Flow Connections” on page 42).

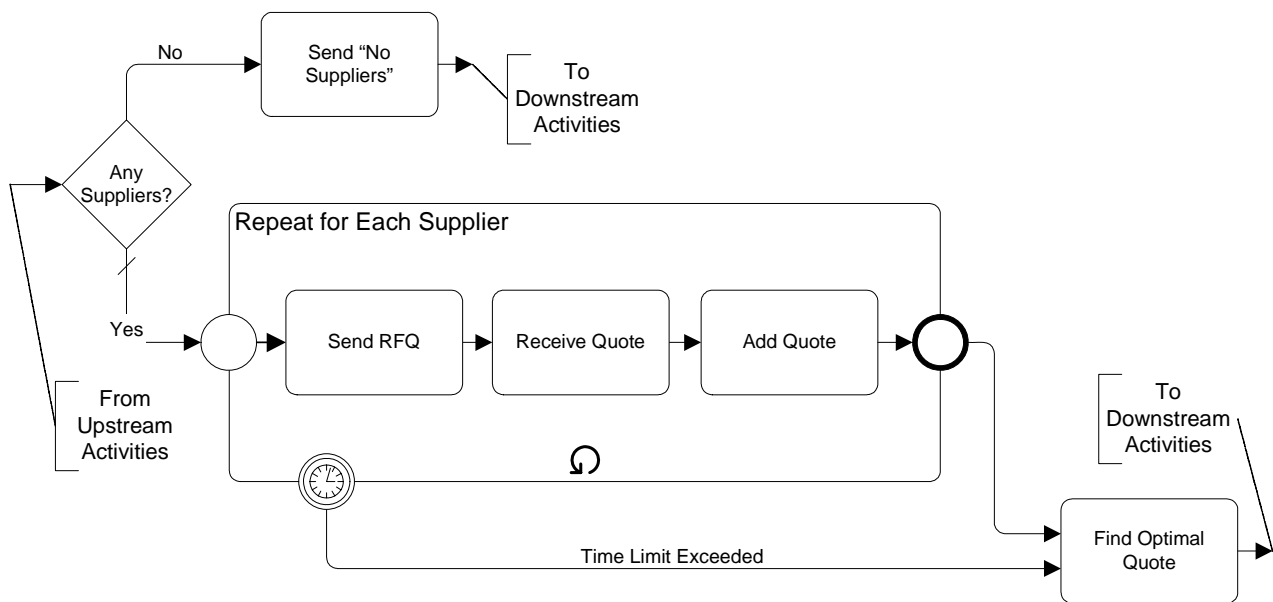

Figure 10.16 - An Expanded Sub-Process with a Start Event and End Event Attached to Boundary

When dealing with Exceptions and Compensation, the traceability requirement is also relaxed (Section 10.2.2, “Exception Flow,” on page 130 and Section 10.3, “Compensation Association,” on page 133).

Forking Flow

BPMN uses the term forking to refer to the dividing of a path into two or more parallel paths (also known as an AND-Split). It is a mechanism that will allow activities to be performed concurrently, rather than sequentially. This is also Workflow Pattern #2 -- Parallel Split⁵. BPMN provides three configurations that provide forking.

The first mechanism to create a fork is simple: a Flow Object can have two or more outgoing Sequence Flow (see Figure 10.17). A special flow control object is not used to fork the path in this case, since it is considered uncontrolled flow; that is, flow will proceed down each path without any dependencies or conditions--there is no Gateway that controls the flow. Forking Sequence Flow can be generated from a Task, Sub-Process, or a Start Event.

5. http://tmitwww.tn.tue.nl/research/patterns/parallel_split.htm

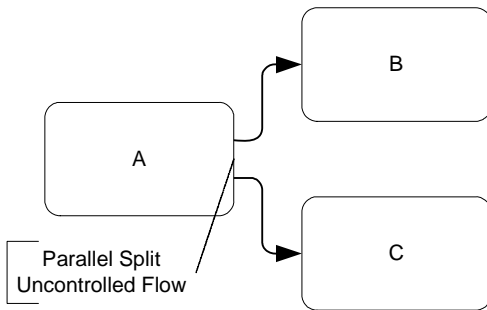

Figure 10.17 - Workflow Pattern #2: Parallel Split -- Version 1

The second mechanism uses a Parallel Gateway (see Figure 10.21). For situations as shown in the Figure 10.18, a Gateway is not needed, since the same behavior can be created through multiple outgoing Sequence Flow, as in Figure 10.17. However, some modelers and modeling tools may use a forking Gateway as a “best practice.” See Section 9.5.5, “Parallel Gateways (AND),” on page 85 for more information on Parallel Gateways.

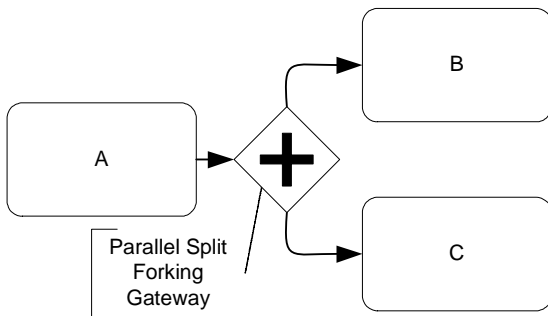

Figure 10.18 - Workflow Pattern #2: Parallel Split -- Version 2

Even when not required as a “best practice,” there are situations where the Parallel Gateway provides a useful indicator of the behavior of the Process. Figure 10.19 shows how a forking Gateway is used when the output of an *Exclusive* Decision requires that multiple activities will be performed based on one condition (Gate).

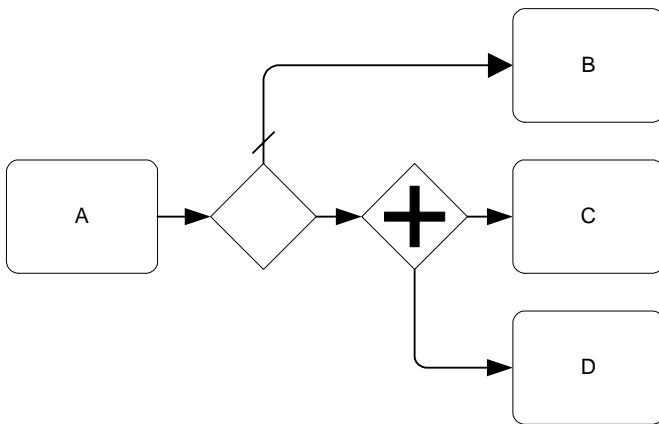

Figure 10.19 - The Creation of Parallel Paths with a Gateway

While multiple conditional Sequence Flow, each with the exact same condition expression (see Figure 10.20), could be used with an *Inclusive* Gateway to create the behavior, the use of a forking Gateway makes the behavior much more obvious.

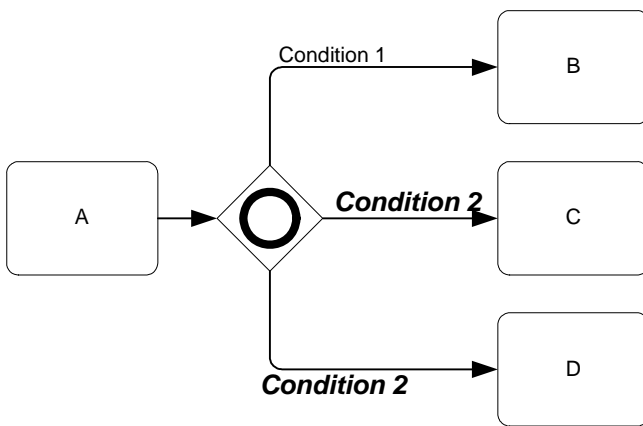

Figure 10.20 - The Creation of Parallel Paths with Equivalent Conditions

This third version of the forking mechanism uses an Expanded Sub-Process to group a set of activities to be performed in parallel (see Figure 10.21). The Sub-Process does not include a Start and End Event and displays the activities “floating” within. A configuration like this can be called a “parallel box” and can be a compact and less cluttered way of showing parallelism in the Process. The capability to model in this way is the reason that Start and End Events are optional in BPMN.

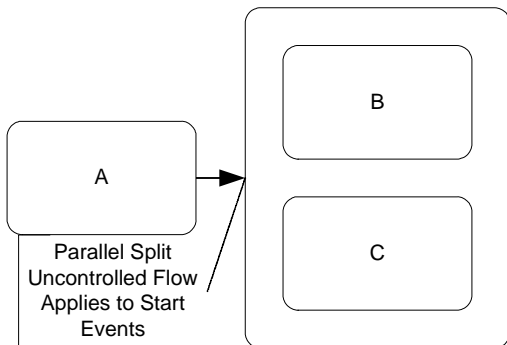

Figure 10.21 - Workflow Pattern #2: Parallel Split -- Version 3

Most of the time, the paths that have been divided with a fork are combined back together through a join (refer to the next section) and synchronized before the flow will continue. However, BPMN provides the flexibility for advanced methods to handle complex process situations. Thus, the exact behavior will be determined by the configuration of the Sequence Flow and the Gateways that are used.

Joining Flow

BPMN uses the term joining to refer to the combining of two or more parallel paths into one path (also known as an AND-Join). A Parallel Gateway is used to synchronize two or more incoming Sequence Flow (see Figure 10.22). In general, this means that Tokens created at a fork will travel down parallel paths and then meet at the Parallel Gateway. From there, only one Token will continue. This is also Workflow Pattern #3 -- Synchronization⁶. Section 9.5.5, “Parallel Gateways (AND),” on page 85 for more information on Parallel Gateways.

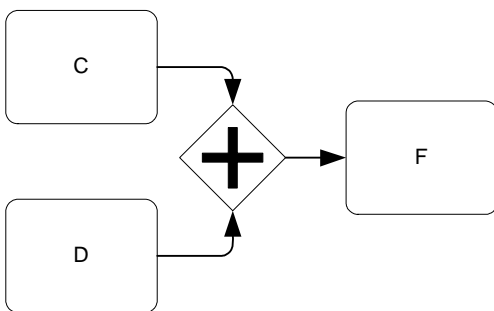

Figure 10.22 - Workflow Pattern #3: Synchronization -- Version 1

Another mechanism for synchronization is the completion of a Sub-Process (see Figure 10.23). If there are parallel paths within the Sub-Process that are *not* synchronized with an Parallel Gateway, then they will eventually reach an End Event (even if the End Event is implied). The default behavior of a Sub-Process is to wait until all activity within has been completed before the flow will move back up to a higher level Process. Thus, the completion of a Sub-Process is a synchronization point.

6. <http://tmitwww.tm.tue.nl/research/synchronization.htm>

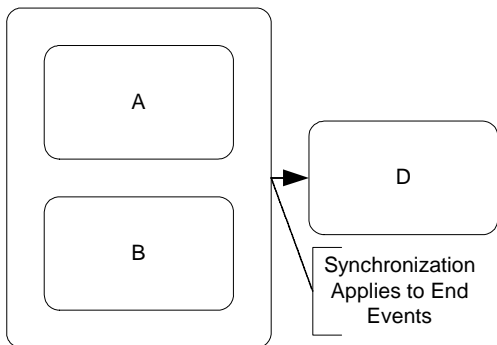

Figure 10.23 - Workflow Pattern #3: Synchronization -- Version 2

There is no specific correlation between the joining of a set of parallel paths and the forking that created the parallel paths. For example, an activity may have three outgoing Sequence Flow, which creates a fork of three parallel paths, but these three paths do not need to be joined at the same object. Figure 10.24 shows that two of three parallel paths are joined at Task “F.” All of the paths eventually will be joined, but this can happen through any combination of objects, including lone End Events. In fact, each path could end with a separate End Event, and then be synchronized as mentioned above.

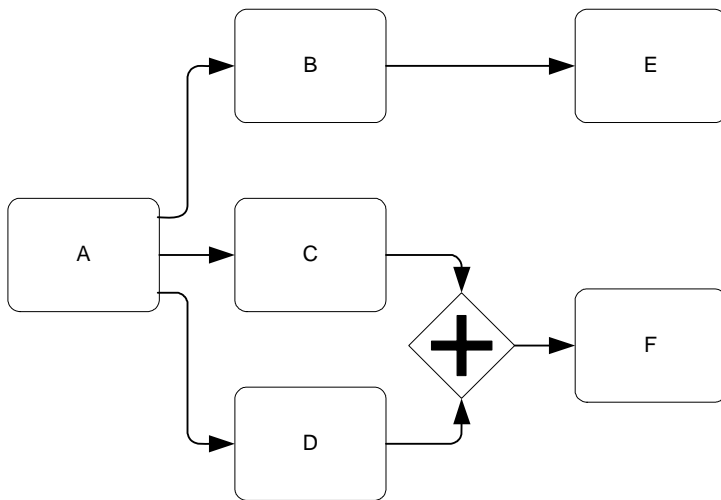

Figure 10.24 - The Fork-Join Relationship is not Fixed

Thus, for parallel flow, BPMN contrasts with BPEL4WS, which is mainly block structured. A BPEL4WS *flow*, which maps to a set of BPMN parallel activities, is a specific block structure that has a well-defined boundary. While there are no obvious boundaries to the parallel paths created by a fork, the appropriate boundaries can be derived by an evaluation of the configuration of Sequence Flow that follow the fork. The locations in the Process where Tokens of the same TokenId and all the appropriate SubTokenIds are joined with through multiple incoming Sequence Flow will determine the boundaries for a specific block of parallel activities. The boundary may in fact be the end of the Process. More detail on the evaluation of BPEL4WS element boundaries can be found in Chapter 11, “Mapping to BPEL4WS.”

Splitting Flow

BPMN uses the term splitting to refer to the dividing of a path into two or more alternative paths (also known as an OR-Split). It is a place in the Process where a question is asked, and the answer determines which of a set of paths is taken. It is the “fork in the road” where a traveler, in this case a Token, can take only one of the forks (not to be confused with forking—see below).

The general concept of splitting the flow is usually referring to as a Decision. In traditional flow charting methodologies, Decisions are depicted as diamonds and usually are exclusive. BPMN also uses a diamond to leverage the familiarity of the shape, but extends the use of the diamond to handle the complex behavior of business processes (which cannot be handled by traditional flow charts). The diamond shape is used in both Gateways and the beginning of a conditional Sequence Flow (when exiting an activity). Thus, when readers of BPD see a diamond, they know that the flow will be controlled in some way and will not just pass from one activity to another. The location of the mini-diamond and the internal indicators within the Gateways will indicate how the flow will be controlled.

There are multiple configurations to split the flow within BPMN so that different types of complex behavior can be modeled. Conditional Sequence Flow and three types of Gateways (Exclusive, Inclusive, and Complex) are used to split the flow. See Section 10.1.2, “Sequence Flow,” on page 100 for details on conditional Sequence Flow. Section 9.5, “Gateways,” on page 68 for details on the Gateways.

There are two basic mechanism for making the Decision during the performance of the Process: the first is an evaluation of a condition expression. There are three variations of this mechanism: Exclusive, Inclusive, and Complex. The first variation, an Exclusive Decision, is the same as Workflow Pattern #4 -- Exclusive Choice⁷ (see Figure 10.25). See “Data-Based” on page 71 for more information on Data-Based Exclusive Gateways.

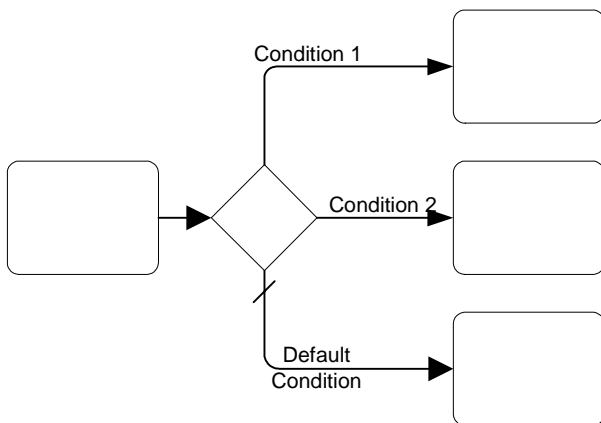

Figure 10.25 - A Data-Based Decision Example -- Workflow Pattern #4 -- Exclusive Choice

The second type of expression evaluation is the Inclusive Decision, which is also Workflow Pattern #6 -- Multiple Choice⁸. There are two configurations of the Inclusive Decision. The first type of Inclusive Decisions uses conditional Sequence Flow from an Activity (see Figure 10.26).

7. http://tmitwww.tm.tue.nl/research/patterns/exclusive_choice.htm

8. http://tmitwww.tm.tue.nl/research/patterns/multiple_choice.htm

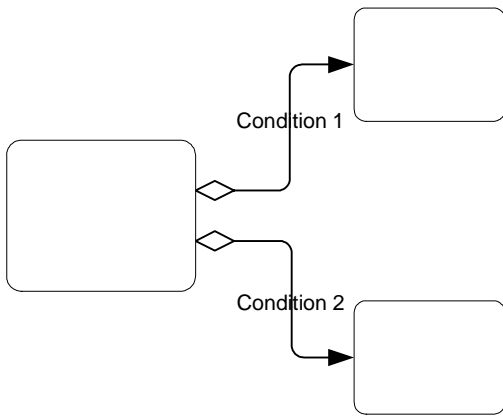

Figure 10.26 - Workflow Pattern #6 -- Multiple Choice -- Version 1

The second type of Inclusive Decisions uses an Inclusive Gateway to control the flow (see Figure 10.27). See Section 9.5.3, “Inclusive Gateways (OR),” on page 78 for more information on Inclusive Gateways.

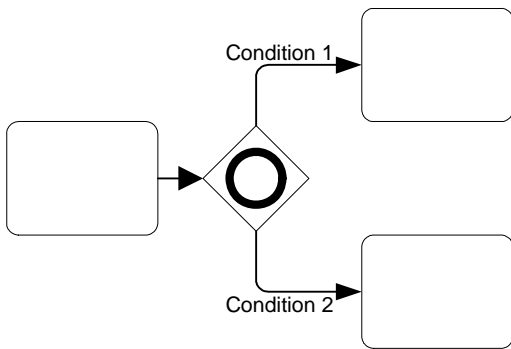

Figure 10.27 - Workflow Pattern #6 -- Multiple Choice -- Version 2

The third type of expression evaluation is the Complex Decision (see Figure 10.28). See Section 9.5.4, “Complex Gateways,” on page 82 for more information on Complex Gateways.

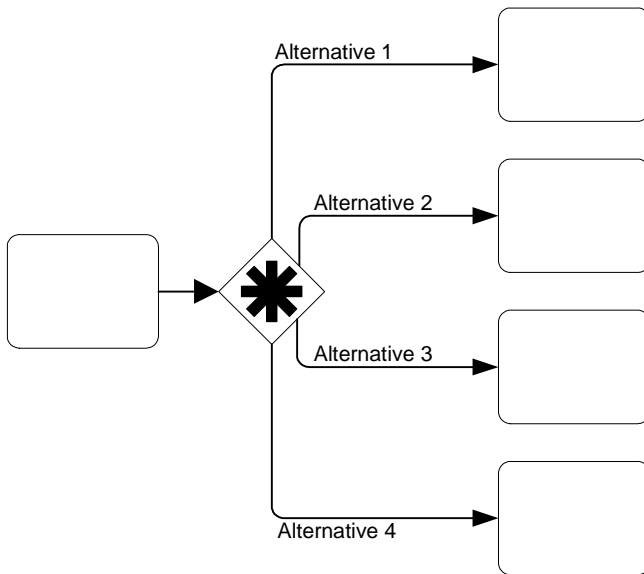

Figure 10.28 - A Complex Decision (Gateway)

The second mechanism for making a Decision is the occurrence of a particular event, such as the receipt of a message (see Figure 10.29). See “Event-Based” on page 75 for more information on Event-Based Exclusive Gateways.

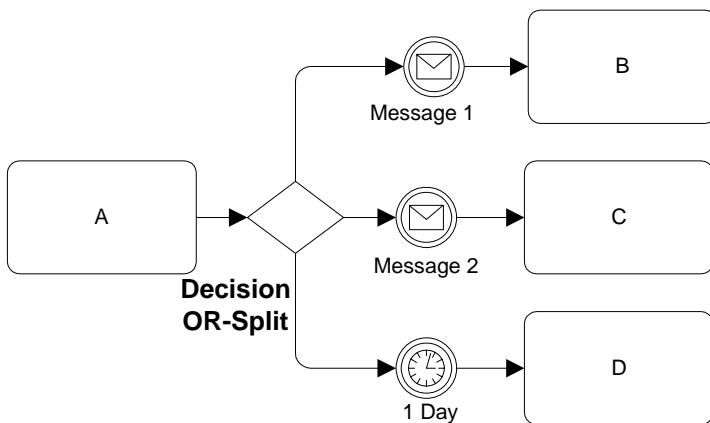

Figure 10.29 - An Event-Based Decision Example

Merging Flow

BPMN uses the term merging to refer to the combining of two or more alternative paths into one path (also known as an OR-Join). It is a place in the process where two or more alternative paths begin to traverse activities that are common to each of the paths. Theoretically, each alternative path can be modeled separately to a completion (an End Event). However, merging allows the paths to overlap and avoids the duplication of activities that are common to the separate paths. For a given instance of the Process, a Token would actually only see the sequence of activities that exist in one of the paths as if it were modeled separately to completion.

Since there are multiple ways that Sequence Flow can be forked and split, there are multiple ways that Sequence Flow can be merged. There are five different Workflow Patterns that can be demonstrated with merging.

The first Workflow Pattern, Simple Merge⁹, The graphical mechanism to merge alternative paths is simple: there are two or more incoming Sequence Flow to a Flow Object (see Figure 10.30). In general, this means that a Token will travel down one of the alternative paths (for a given Process instance) and will continue from there. For that instance, Tokens will never arrive down the other alternative paths. BPMN provides two versions of a Simple Merge.

The first version is shown in Figure 10.30. The two incoming Sequence Flow for activity “D” are uncontrolled. Since the two Sequence Flow are at the end of two alternative paths, created through the upstream exclusive Gateway, only one Token will reach activity “D” for any given instance of the Process.

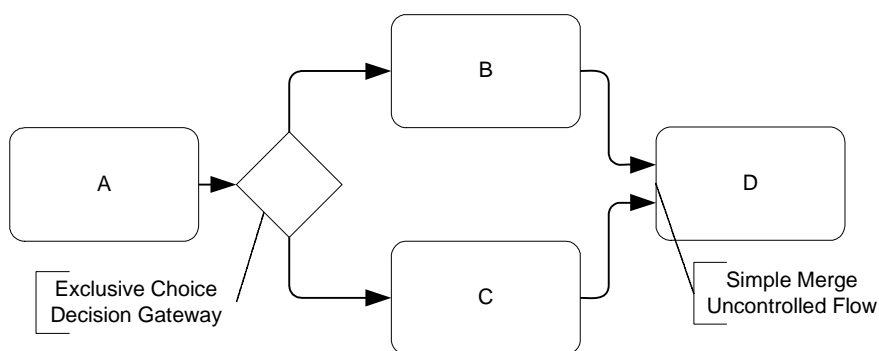

Figure 10.30 - Workflow Pattern #5 -- Simple Merge – Version 1

If the multiple incoming Sequence Flow are actually parallel instead of alternative, then the end result is different, even though the merging configuration is the same as Figure 10.30. In Figure 10.31, the upstream behavior is parallel. Thus, there will be two Tokens arriving (at different times) at activity “D.” Since the flow into activity “D” is uncontrolled, *each Token arriving at activity “D” will cause a new instance of that activity.* This is an important concept for modelers of BPMN should understand. In addition, this type of merge is the Workflow Pattern Multiple Merge¹⁰.

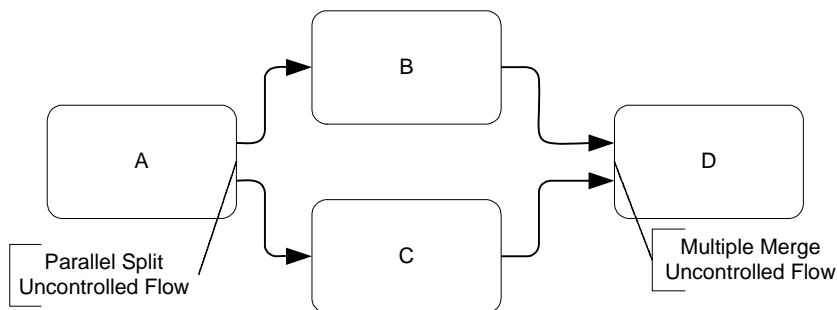

Figure 10.31 - Workflow Pattern #7 -- Multiple Merge

9. http://tmitwww.tm.tue.nl/research/patterns/simple_merge.htm

10. http://tmitwww.tm.tue.nl/research/patterns/multiple_merge.htm

The second version of the Simple Merge is shown in Figure 10.32. The two incoming Sequence Flow for activity “D” are controlled through the Exclusive Gateway. Since the two Sequence Flow are at the end of two alternative paths, created through the upstream exclusive Gateway, only one Token will reach the Gateway for any given instance of the Process. The Token will then immediately proceed to activity “D.”

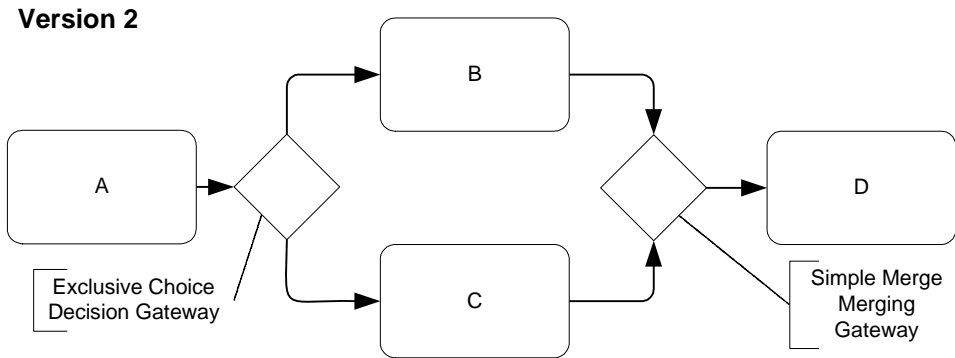

Figure 10.32 - Workflow Pattern #5 -- Simple Merge – Version 2

Again, if the multiple incoming Sequence Flow are actually parallel instead of alternative, then the end result is different, even though the merging configuration is the same as Figure 10.32. In the model shown in Figure 10.33, there will be two Tokens arriving (at different times) at the Exclusive Gateway preceding activity “D.” In this situation, the Gateway will accept the first Token and immediately pass it on through to the activity. When the second Token arrives, it will be *excluded* from the remainder of the flow. This means that the Token will not be passed on to the activity, but will be consumed. This type of merge is the Workflow Pattern Discriminator¹¹.

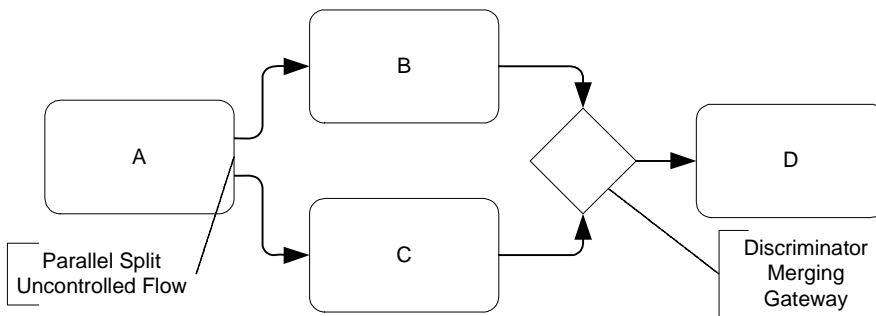

Figure 10.33 - Workflow Pattern #8 -- Discriminator

The fourth type of Workflow Pattern merge is called a Synchronizing Join¹². This is a situation when the merging location does not know ahead of time how many Tokens will be arriving at the Gateway. In some Process instances, there may be only one Token. In other Process instances, there may be more than one Token arriving. This type of situation is created when an Inclusive Decision is made up stream (see Figure 10.34). To handle this, an Inclusive Gateway can be used to

11. <http://tmitwww.tm.tue.nl/research/patterns/discriminator.htm>
 12. http://tmitwww.tm.tue.nl/research/patterns/synchronizing_join.htm

merge the appropriate number of Tokens for each Process instance. The Gateway, following the pattern Synchronizing Join, will wait for all expected Tokens before the flow will continue to the next activity. Section 9.5.3, “Inclusive Gateways (OR),” on page 78 for more information on Inclusive Gateways.

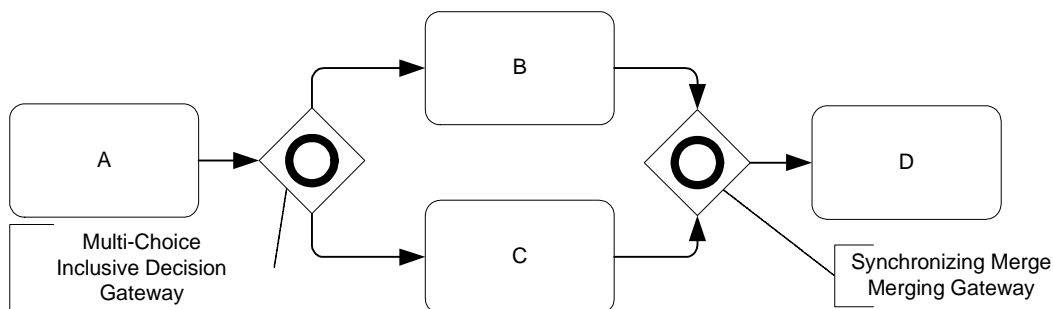

Figure 10.34 - Workflow Pattern #9 -- Synchronizing Join

The fourth type of Workflow Pattern merge is called a N out of M Join¹³. This type of situation is more complex and can be handled through a Complex Gateway (see Figure 10.35). The Gateway will receive Tokens from its incoming Sequence Flow and evaluate an expression to determine whether or not the flow should proceed. Once the condition has been satisfied, if additional Tokens arrive, they will be excluded (much like the Discriminator Pattern from Figure 10.33). Section 9.5.4, “Complex Gateways,” on page 82 for more information on Complex Gateways.

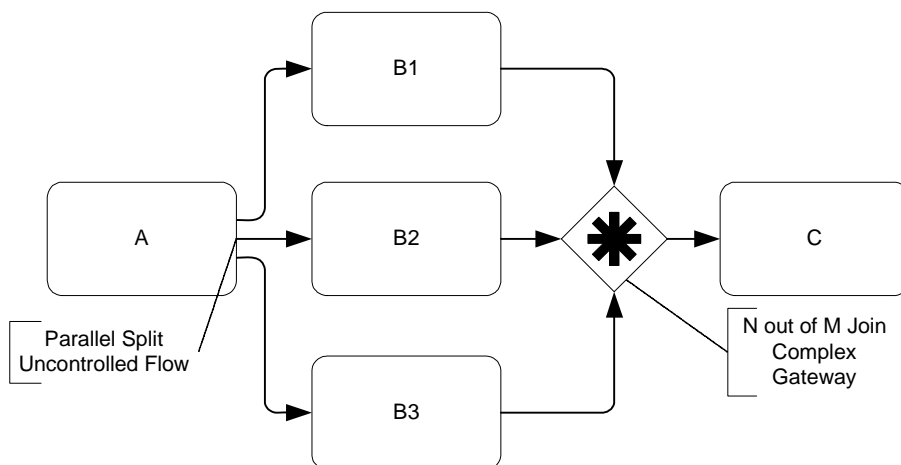

Figure 10.35 - Workflow Pattern #8 -- N out of M Join

There is no specific correlation between the merging of a set of paths and the splitting that occurs through a Gateway object. For example, a Decision may split a path into three separate paths, but these three paths do not need to be merged at the same object. Figure 10.36 shows that two of three alternative paths are merged at Task “F.” All of the paths eventually will be merged, but this can happen through any combination of objects, including lone End Events. In fact, each path could end with a separate End Event.

13. http://tmitwww.tm.tue.nl/research/patterns/n_out_of_m_join.htm

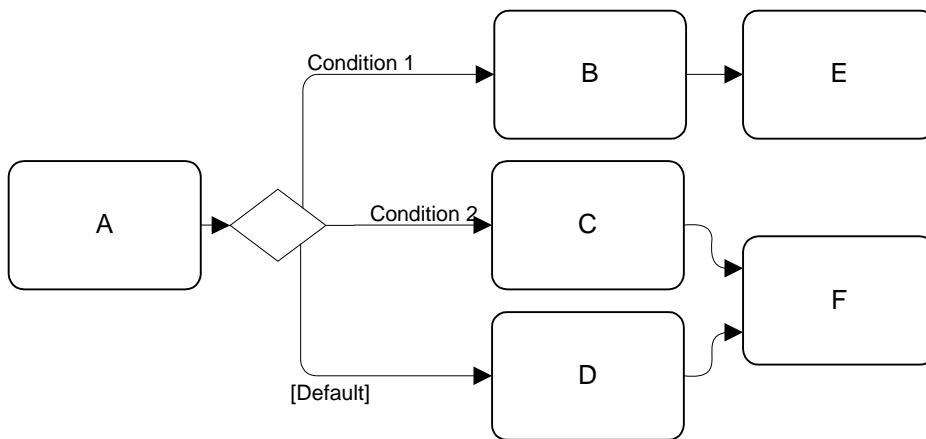

Figure 10.36 - The Split-Merge Relationship is not Fixed

Thus, for alternative flow, BPMN contrasts with BPEL4WS, which is mainly block structured. BPEL4WS *switch* and *pick*, which map to the BPMN Exclusive Gateway, are specific block structures that have well-defined boundaries. While there are no obvious boundaries to the alternative paths created by a decision in BPMN, the appropriate boundaries can be derived by an evaluation of the configuration of Sequence Flow that follow the decision. The locations in the Process where Tokens of the same identity are merged through multiple incoming Sequence Flow will determine the boundaries for a specific decision. The boundary may in fact be the end of the Process. More detail on the evaluation of BPEL4WS element boundaries can be found in the “Mapping to BPEL4WS” (Chapter 11).

Looping

BPMN provides 2 (two) mechanisms for looping within a Process. The first involves the use of attributes of activities to define the loop. The second involves the connection of Sequence Flow to “upstream” objects.

Activity Looping

The attributes of Tasks and Sub-Processes will determine if they are repeated as a loop. There are two types of loops that can be specified: Standard and Multi-Instance.

For Standard Loops:

- If the loop condition is evaluated before the activity, this is generally referred to as a “while” loop. This means that the activities will be repeated as long as the condition is true. The activities may not be performed at all (if the condition is false the first time) or performed many times.
- If the loop condition is evaluated after the activity, this is generally referred to as an “until” loop. This means that the activities will be repeated until a condition becomes true. The activities will be performed at least once, but may be performed many times.

For Multi-Instance Loops:

- If the MI_Ordering is serial, then this becomes much like a while loop with a set number of iterations the loop will go through. These are often used in processes where a specific type of item will have a set number of sub-items or line items. A Multi-Instance loop will be used to process each of the line items.
- If the MI_Ordering is parallel, this is generally referred to as multiple instances of the activities. An example of this type of feature would be used in a process to write a book, there would be a Sub-Process to write a chapter. There

would be as many copies or instances of the Sub-Process as there are chapters in the book. All the instances could begin at the same time.

Those activities that are repeated (looped) will have a loop marker placed in the bottom center of the activity shape (see Figure 10.37). Those activities that are Parallel Multi-Instance will have a parallel marker placed in the bottom center of the activity shape (see Figure 10.38)

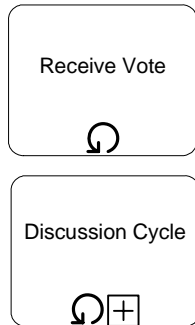

Figure 10.37 - A Task and a Collapsed Sub-Process with a Loop Marker

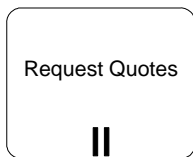

Figure 10.38 - A Task with a Parallel Marker

Expanded Sub-Processes also can have a loop marker placed at the bottom center of the Sub-Process rectangle (see Figure 10.39). The entire contents of the Sub-Process will be repeated as defined in the attributes.

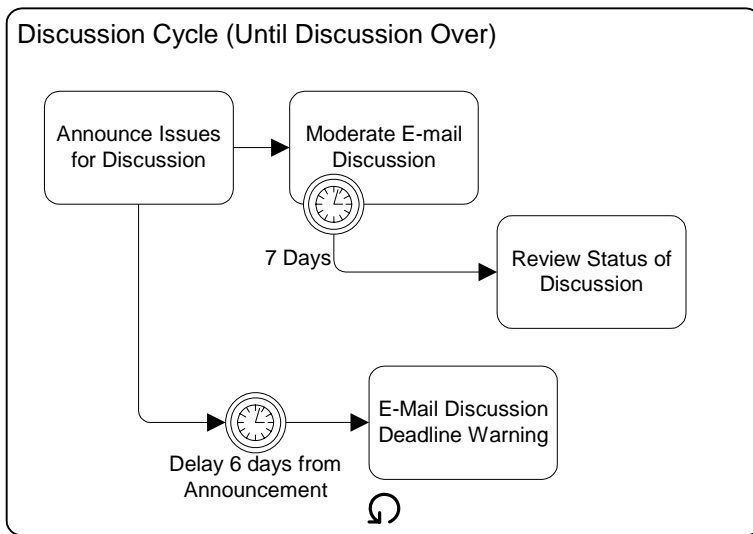

Figure 10.39 - An Expanded Sub-Process with a Loop Marker

Sequence Flow Looping

Loops can also be created by connecting a Sequence Flow to an “upstream” object. An object is considered to be upstream if that object has an outgoing Sequence Flow that leads to a series of other Sequence Flow, the last of which turns out to be an incoming Sequence Flow to the original object. That is, that object produces a Token and that Token traverses a set of Sequence Flow until the Token reaches the same object again. Sequence Flow looping is the same as Workflow Pattern #16 -- Arbitrary Cycle¹⁴ (see Figure 10.25).

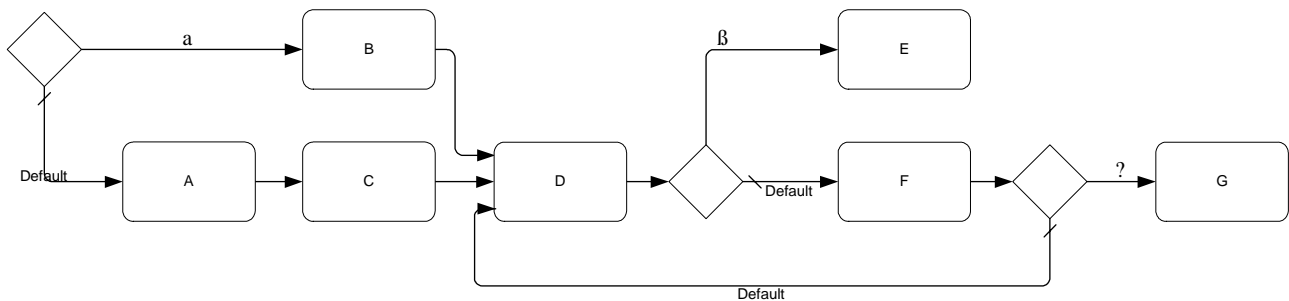

Figure 10.40 - Workflow Pattern #16 -- Arbitrary Cycle

Usually these connections follow a Decision so that the loop is not infinite (see Figure 10.41). If the Sequence Flow goes directly from a Decision to an upstream object, this is an “until” loop. The set of looped activities will occur until a certain condition is true.

14. http://tmitwww.tn.tue.nl/research/patterns/arbitrary_cycle.htm

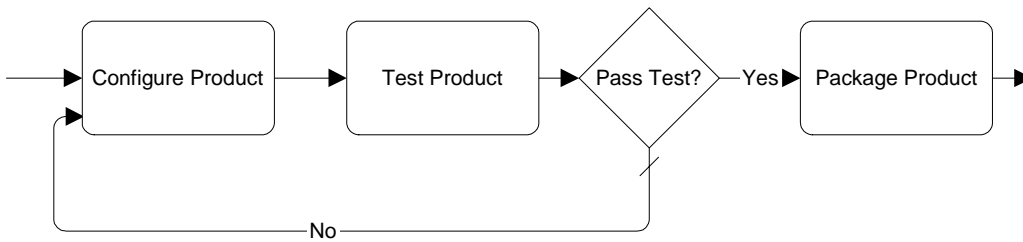

Figure 10.41 - An Until Loop

A while loop is created by making the decision first and then performing the repeating activities or moving on in the Process (see Figure 10.42). The set of looped activities may not occur or may occur many times.

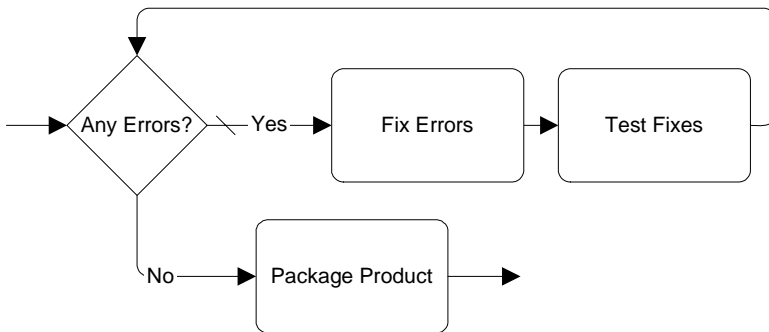

Figure 10.42 - A While Loop

Sequence Flow Jumping (Off-Page Connectors and Go To Objects)

Since process models often extend beyond the length of one printed page, there is often a concern about showing how Sequence Flow connections extend across the page breaks. One solution that is often employed is the use of Off-Page connectors to show where one page leaves off and the other begins. BPMN provides Intermediate Events of type Link for use as Off-Page connectors (see Figure 10.43--Note that the figure shows two different printed pages, not two Pools in one diagram). A pair of Link Intermediate Events is used. One of the pair is shown at the end of one page. This Event is named and has an incoming Sequence Flow and no outgoing Sequence Flow. The second Link Event is at the beginning of the next page, shares the same name, and has an outgoing Sequence Flow and no incoming Sequence Flow.

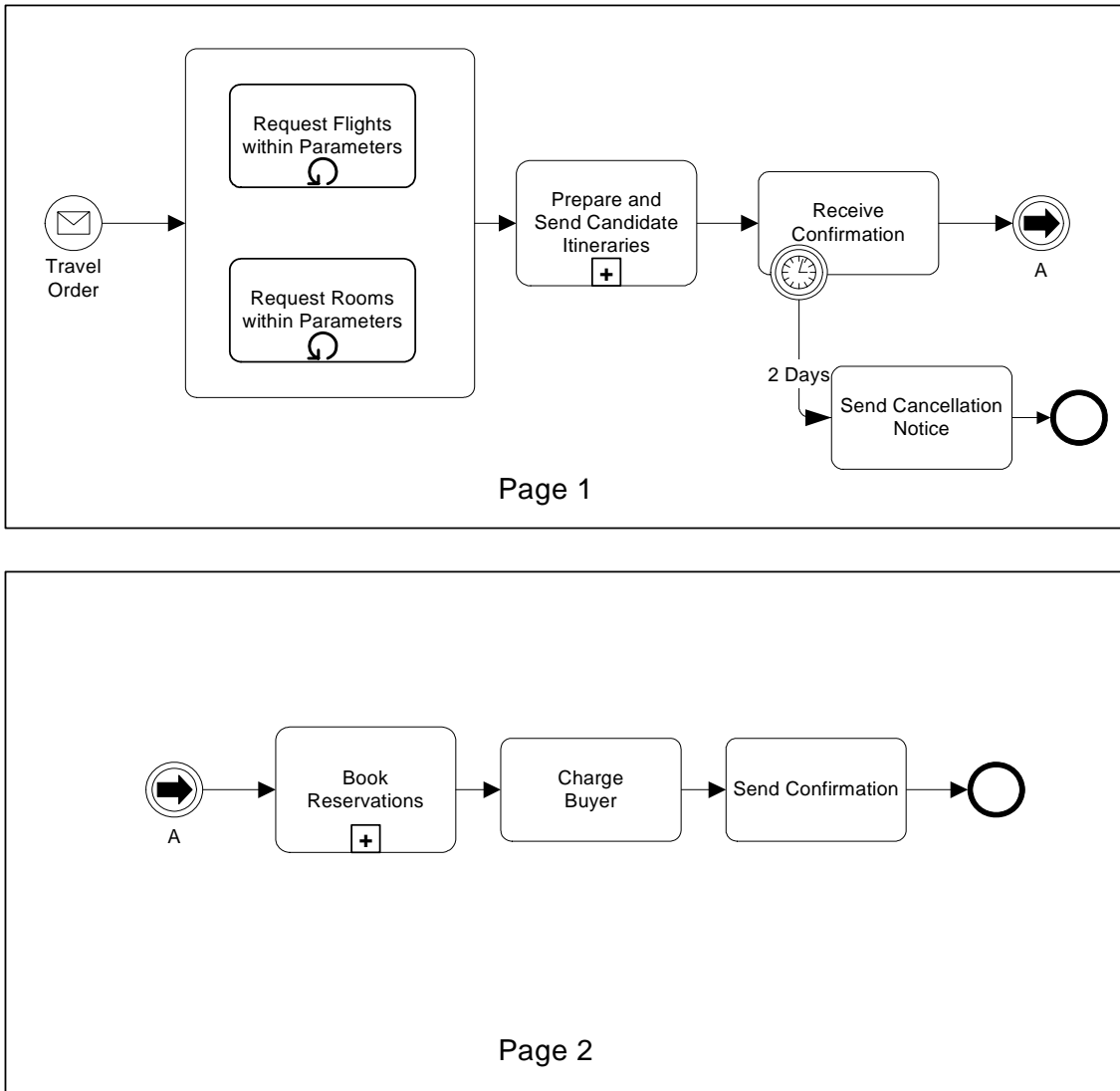

Figure 10.43 - Link Intermediate Event Used as Off-Page Connector

Another way that Link Intermediate Events can be used is as “Go To” objects. Functionally, they would work the same as for Off-Page Connectors (described above), except that they could be used anywhere in the diagram--on the same page or across multiple pages. The general idea is that they provide a mechanism for reducing the length of Sequence Flow lines. Some modelers may consider long lines as being hard to follow or trace. Go To Objects can be used to avoid very long Sequence Flow (see Figure 10.44 and Figure 10.45). Both diagrams will behave equivalently. For Figure 10.45, if the “Order Rejected” path is taken from the Decision, then the Token traversing the Sequence Flow would reach the source Link Event and then “jump” to the target Link Event and continue down the Sequence Flow. The process would continue as if the Sequence Flow had directly connected the two objects.

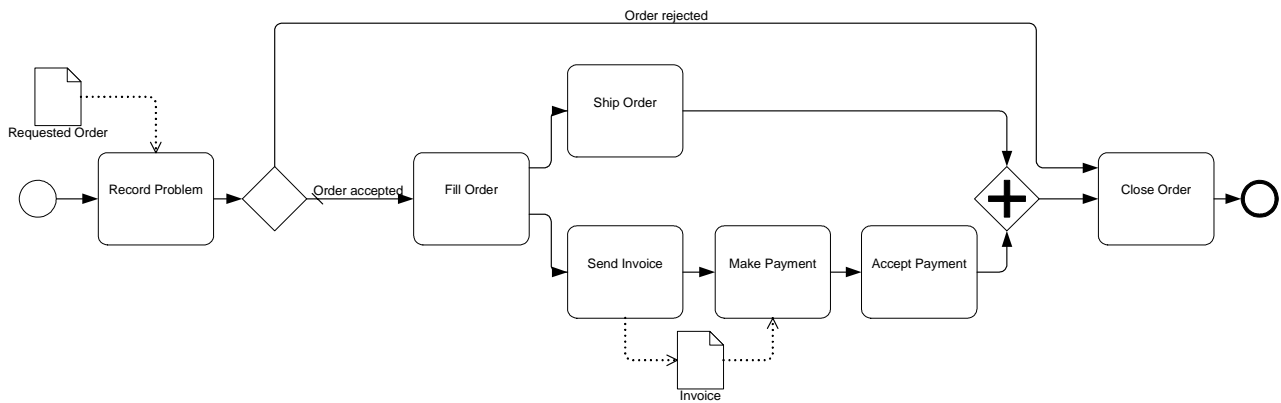

Figure 10.44 - Process with Long Sequence Flow

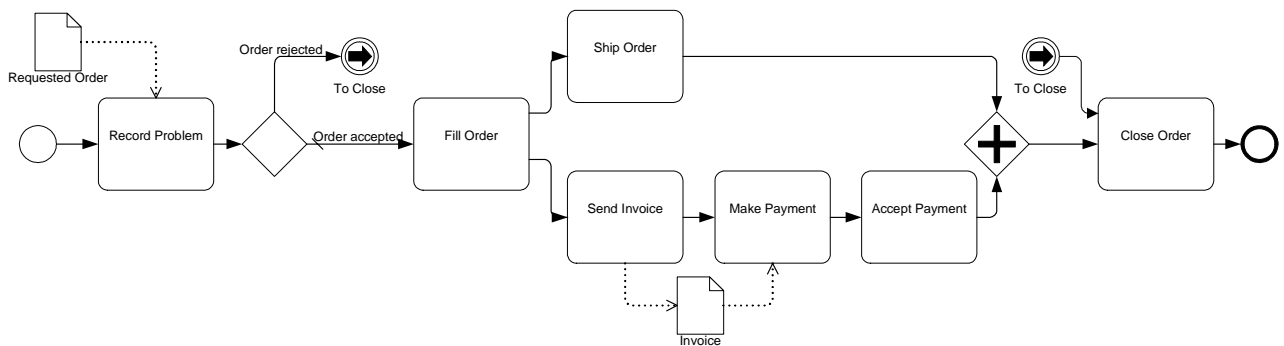

Figure 10.45 - Process with Link Intermediate Events Used as Go To Objects

Some methodologies prefer that all Sequence Flow only move in one direction; that is, forward in time. These methodologies do not allow Sequence Flow to connect directly to upstream objects. Some consistency in modeling can be gained by such a methodology, but situations that require looping become a challenge. Link Intermediate Events can be used to make upstream connections and create loops without violating the Sequence Flow direction restriction (see Figure 10.46).

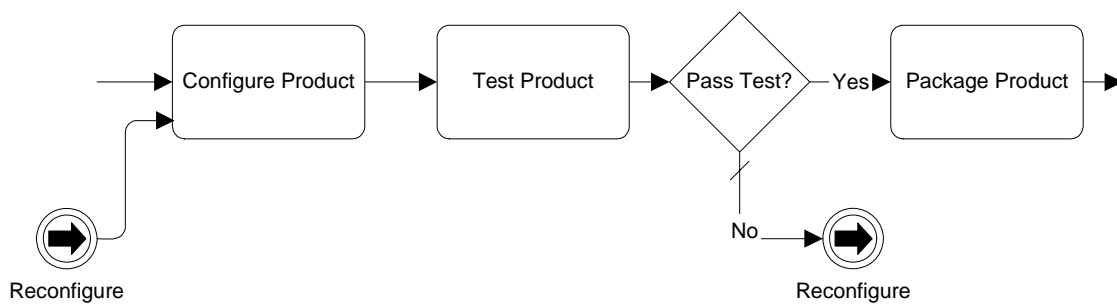

Figure 10.46 - Link Intermediate Event Used for Looping

Passing Flow to and from Sub-Processes

This section reviews how flow will be passed between a parent Process and any of its Sub-Processes. The flow (e.g., a Token) will start at the parent Process and then move to the Sub-Process and then will move back to the parent process (see Figure 10.47). Most of the time the flow will reach a Sub-Process, get transferred to the Start Event of the Sub-Process, traverse the Sequence Flow of the Sub-Process, reach the End Event of the Sub-Process, and, finally, get transferred back to the parent Process to continue down the outgoing Sequence Flow of the Sub-Process object. If the Sub-Process contains parallel Flow, then all the Flow must complete before a Token is transferred back to the parent Process. This functionality treats the Sub-Process as a self-contained “box” of activities.

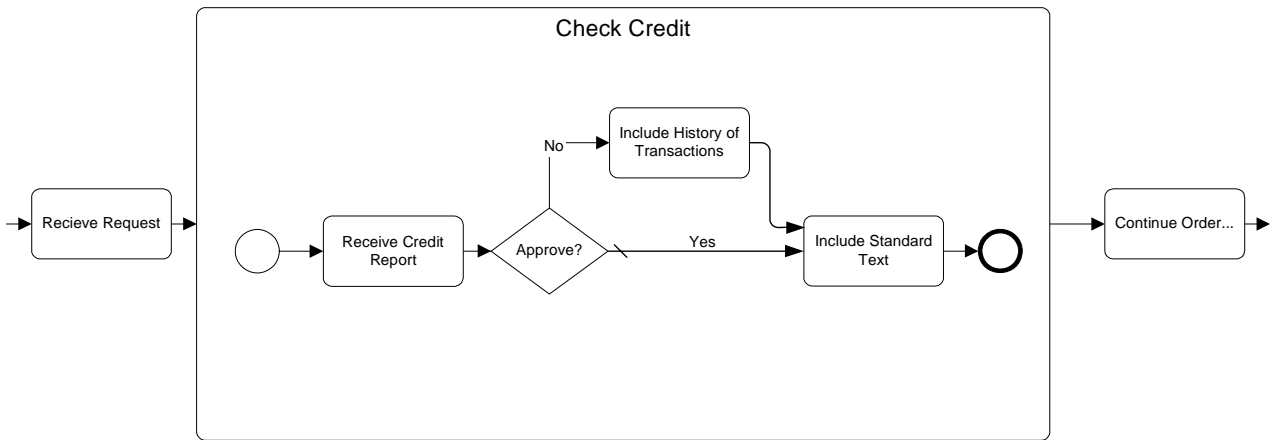

Figure 10.47 - Example of Sub-Process with Start and End Events Inside

To make the flow between levels of a Process more obvious, a modeler has the option of placing the Start Event and the End Event on the boundary of the Sub-Process and connect the Sequence Flow from the Parent Process objects to/from these Events (see Figure 10.48).

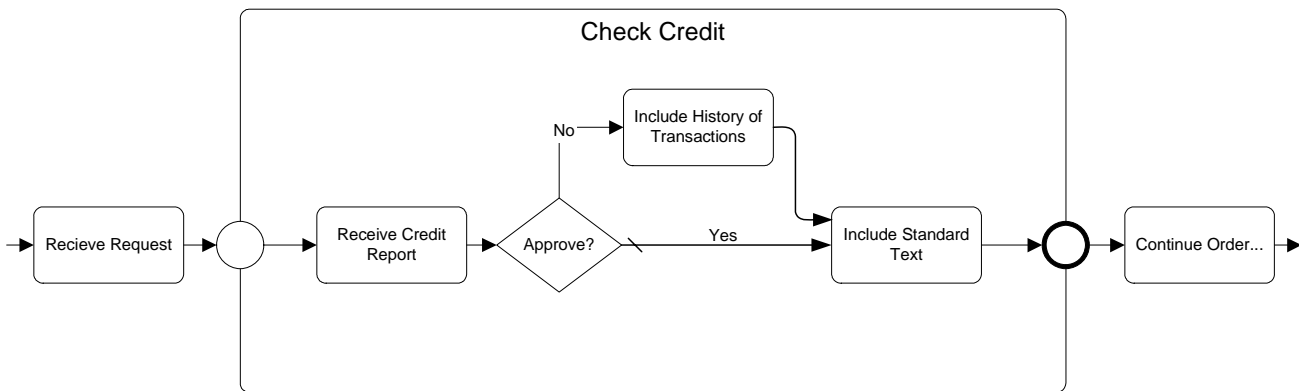

Figure 10.48 - Example of Sub-Process with Start and End Events on Boundary

Controlling Flow Across Processes

There may be situations within a Process where the flow is affected by or dependent on the activity that occurs in another Process. These events or conditions can be referred to as milestones. The process model must be able to identify and react to the milestone. That is, the starting or continuation of a Process may be triggered by Link Events, which pass the flow (Tokens) between processes (see Figure 10.49). The type of Workflow Pattern called a Milestone¹⁵.

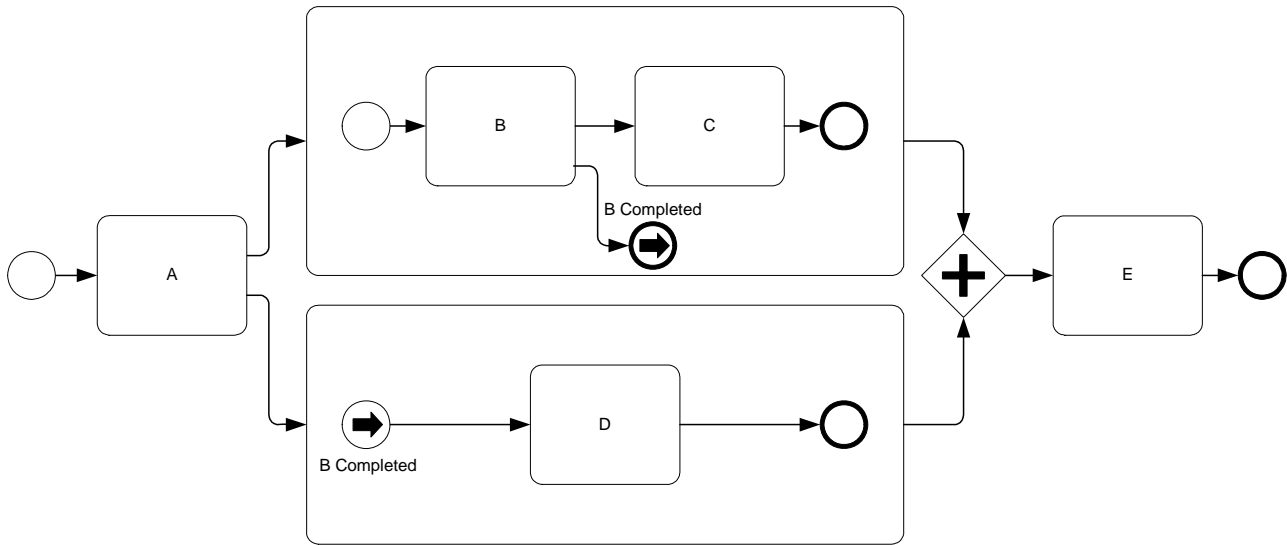

Figure 10.49 - Link Events Used to Synchronize Behavior Across Processes

Avoiding Illegal Models and Unexpected Behavior

BPMN, being a graph-structured Diagram, rather than having a block-structures like BPEL4WS, provides a great flexibility for depicting complex process behavior in a fairly compact form. However, the free-form nature of BPMN can create modeling situations that cannot be executed or will behave in a manner that is not expected by the modeler. These types of modeling problems can occur because there is not a tight relationship between forks and joins or splits and merges. A block structure provides these tight relationships, but a graph-structure allows these flow control mechanisms to be mixed and matched at the discretion of the modeler. Some combinations of these control elements will create Processes that cannot be executed or will create behavior that was not intended by the modeler. The situation where alternative paths cross the implicit boundary of a group of parallel paths can cause an invalid model.

Figure 10.50 shows such a model. Task “D” is an activity that has two incoming Sequence Flow; one from a forked path (after a split path) and one from a split path. This can create a problem at the Parallel Gateway that precedes Task “E,” which also has multiple incoming Sequence Flow. The Sequence Flow from Task “B” is crossing the implicit boundary of the fork created after Task “A.” As a result, if the “Yes” Sequence Flow is taken from the Decision in the Diagram (Variation 1), then Task “E” can expect two Tokens to arrive—one from Task “C” and one from Task “D.” However, if the “No” Sequence Flow is taken from the Decision (Variation 2), the Parallel Gateway will receive only one Token—one from Task “D.” Since the Gateway expects two Tokens, the Process will be dead-locked at that position.

15. <http://tmitwww.tn.tue.nl/research/patterns/milestone.htm>

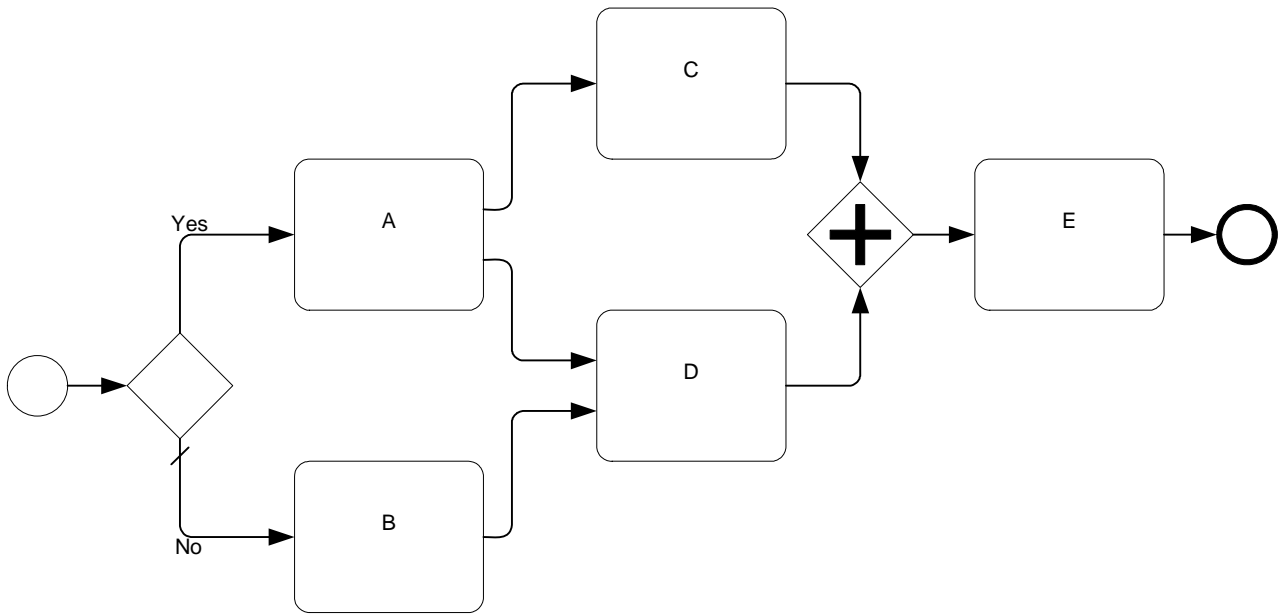

Figure 10.50 - Potentially a dead-locked model

Another type of problem occurs with looping back to upstream activities. If the loop Decision is made within the implicit boundaries of a set of parallel paths, then the behavior of the loop becomes ambiguous (see Figure 10.51), since it is unclear whether Task “E” was intended to be repeated based on the loop or what would happen if Task “E” was still active when the loop reached that Task again.

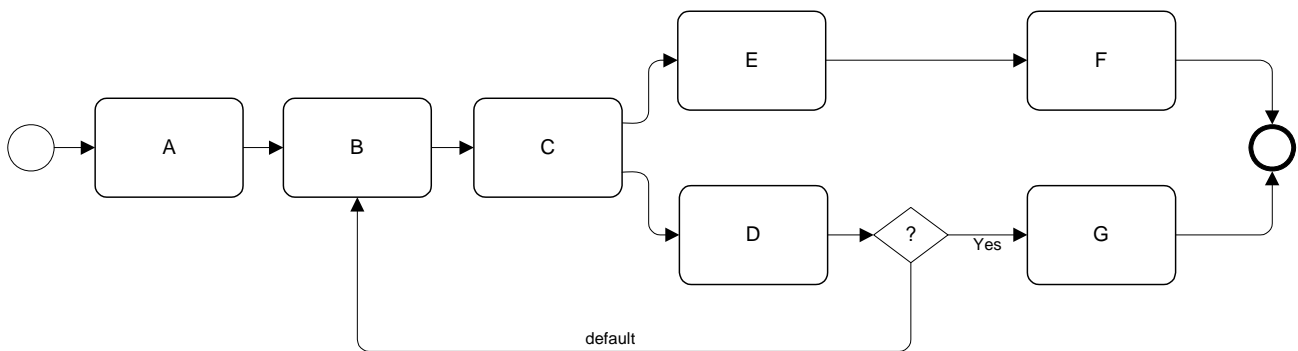

Figure 10.51 - Improper Looping

The use of Link Events can also create unexpected behavior. In general, Link Events not used for off-page connectors should be considered an advanced modeling technique and the modeler should be careful to understand the resultant behavior and flow of Tokens.

Figure 10.52 is a variation of Figure 10.49. In this figure, however, the Link End Event in the top Sub-Process is not used properly. For the top Sub-Process, there is only one Token generated and available. When the Token leaves Task “C” and arrives at the Link End Event, it is consumed by the Event, but then immediately jumps to the target Start Event that

shares its name (in the bottom Sub-Process). Because the Token jumps to the other Sub-Process, there is no Token left to be transferred up to the Parent Process and continue down the outgoing Sequence Flow of the top Sub-Process. Thus, the overall Process will be stuck waiting at the Parallel Gateway for a Token that will never arrive.

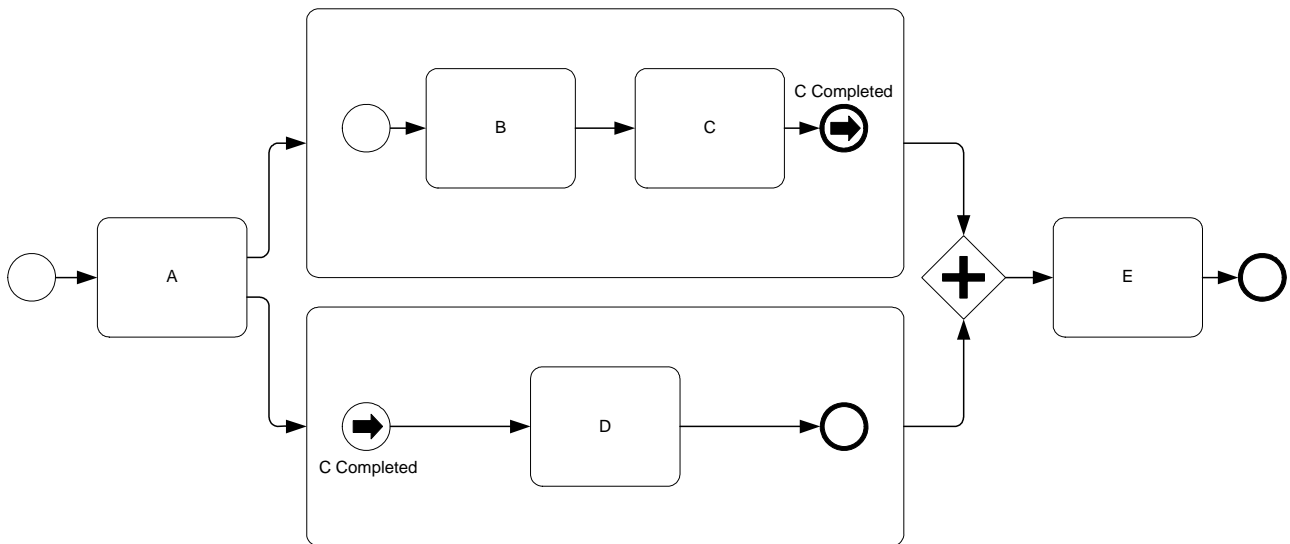

Figure 10.52 - Improper use of a Link End Event

In general, the analysis of how Tokens will flow through the model will help find models that cannot be executed properly. This Token flow analysis will be used to create some of the mappings to BPEL4WS. Since BPEL4WS is properly executable, if the Token flow analysis cannot create a valid BPEL4WS process, then the model is not structured correctly.

Changes Since 1.0 Draft Version

These are the changes since the last publicly released version:

- The “Sequence Flow Jumping (Off-Page Connectors and Go To Objects)” on page 124 was added.
- The “Controlling Flow Across Processes” on page 128 was added.
- The “Avoiding Illegal Models and Unexpected Behavior” on page 128 was updated to show an example of how Link Events can cause unexpected behavior.

10.2.2 Exception Flow

Exception Flow occurs outside the Normal Flow of the Process and is based upon an event (an Intermediate Event) that occurs during the performance of the Process. While Intermediate Events can be included in the Normal Flow to set delays or breaks to wait for a message, when they are attached to the boundary of an activity, either a Task or a Sub-Process (see Figure 10.53), they create Exception Flow.

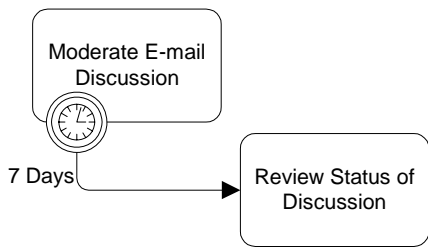

Figure 10.53 - A Task with Exception Flow (Interrupts Event Context)

By doing this, the modeler is creating an Event Context. The Event Context will respond to specific Triggers to interrupt the activity and redirect the flow through the Intermediate Event. The Event Context will only respond if it is active (running) at the time of the Trigger. If the activity has completed, then the Trigger may occur with no response. The source of the Trigger may be external to the Process execution, such as a message or an application error, or the Trigger may be caused by a “throw” Intermediate Event from any other active location within the Process.

If there are a group of Tasks that the modeler wants to include in an Event Context, then a Sub-Process can be added to encompass the Tasks and to handle any events by having them attached to its boundary (see Figure 10.54).

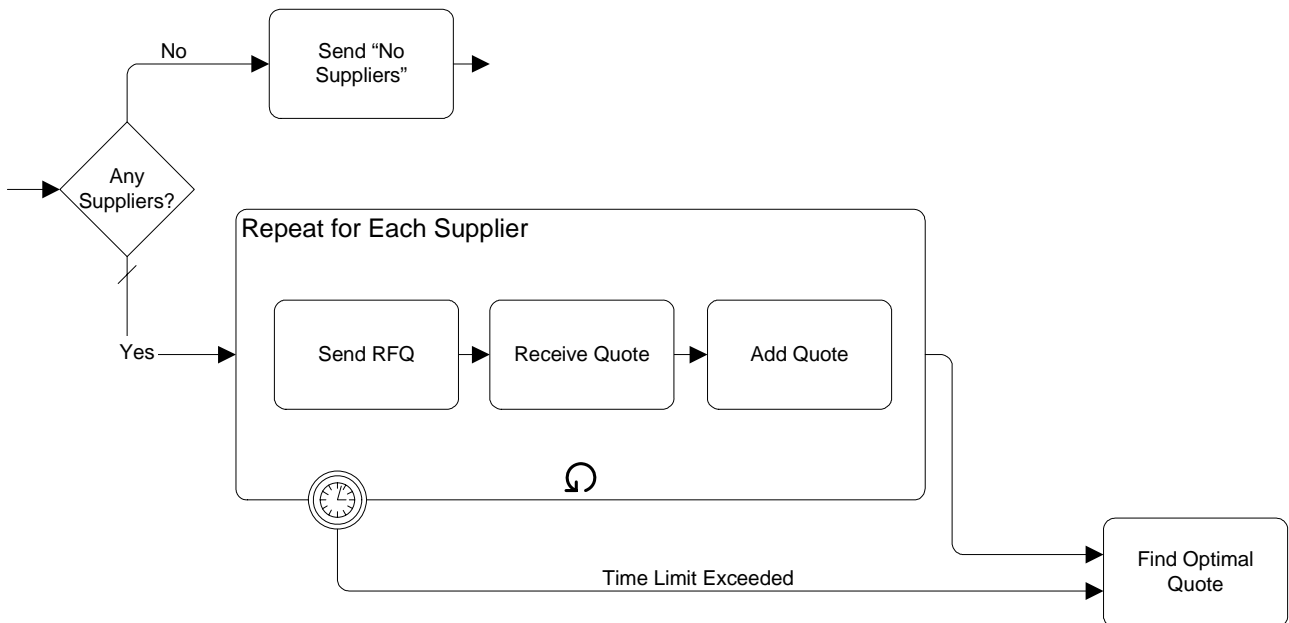

Figure 10.54 - A Sub-Process with Exception Flow (Interrupts Event Context)

Two Triggers for Intermediate Event are used by Event Contexts at the level of the execution language (BPEL4WS): Message, and Error (fault). A Message Event occurs when a message, with the exact identity as specified in the Intermediate Event, is received by the Process. An Error Event occurs when the Process detects an Error. If an Error Code is specified in the Intermediate Event, then the code of the detected Error must match for the Event Context to respond. If the Intermediate Event does not specify an Error Code, then any Error will trigger a response from the Event Context.

Other BPMN Triggers, such as a Timer, must be converted into a BPEL4WS configuration that will generate the appropriate Message or Error (see Section 11.13, “Exception Flow,” on page 182 for details of a mapping of Exception Flow to BPEL4WS).

If this event does not occur while the Event Context is ready, then the Process will continue through the Normal Flow as defined through the Sequence Flow.

10.2.3 Ad Hoc

An Ad Hoc Process is a group of activities that have no pre-definable sequence relationships. A set of activities can be defined for the Process, but the sequence and number of performances for the activities is completely determined by the performers of the activities and cannot be defined beforehand.

A Sub-Process is marked as being an Ad Hoc with a “tilde” symbol placed at the bottom center of the Sub-Process shape (see Figure 10.55 and Figure 10.56). Activities within the Process are disconnected from each other. During execution of the Process, any one or more of the activities may be active and they can be performed in almost any order or frequency.

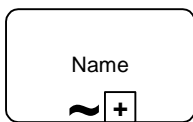

Figure 10.55 - A Collapsed Ad Hoc Sub-Process

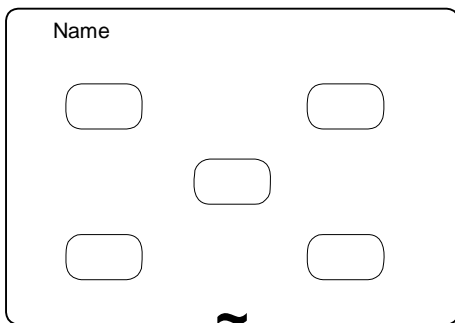

Figure 10.56 - An Expanded Ad Hoc Sub-Process

The performers determine when activities will start, when they will end, what the next activity will be, and so on. Examples of the types of Processes that are Ad Hoc include computer code development (at a low level), sales support, and writing a book chapter. If we look at the details of writing a book chapter, we could see that the activities within this Process include: researching the topic, writing text, editing text, generating graphics, including graphics in the text, organizing references, etc. (see Figure 10.57). There may be some dependencies between Tasks in this Process, such as writing text before editing text, but there is not necessarily any correlation between an instance of writing text to an instance of editing text. Editing may occur infrequently and based on the text of many instances of the writing text Task.

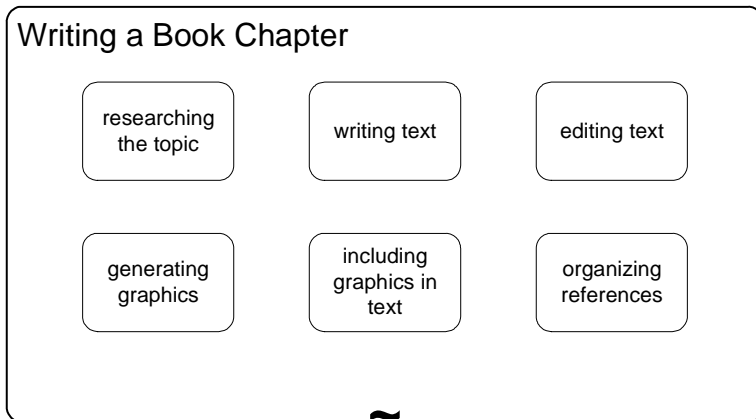

Figure 10.57 - An Ad Hoc Process for Writing a Book Chapter

It is a challenge for a BPM engine to monitor the status of Ad Hoc Processes, usually these kind of processes are handled through groupware applications (such as e-mail), but BPMN allows modeling of Processes that are not necessarily executable and should provide the mechanisms for those BPM engines that can follow an Ad Hoc Process. Given this, at some point, the Process will have completed and this can be determined by evaluating a Completion Condition that evaluates Process attributes that will have been updated by an activity in the Process.

10.3 Compensation Association

Some activities produce complex effects or specific outputs. If the outcome is determined to be undesirable by some specified criteria (such as an order being cancelled), then it will be necessary to “undo” the activities. There are three ways this can be done:

- Restoring of a copy of the initial values for data, thereby overwriting any changes.
- Doing nothing (if nothing has be changed because the changes have been set aside until a confirmation).
- Invoking activities that undo the effects--also known as compensation.

An activity that might require compensation could be, for example, one that charges a buyer for some service and debits a credit card to do so. These types of activities usually need a separate activity to counter the effects of the initial activity. Often, a record of both activities is required, so this is another reason that the activity is not “undone.” An Intermediate Event of type Compensation is attached to the boundary of an activity to indicate that compensation may be necessary for that activity.

One of the three mechanisms for “undo” activities, Compensation, requires specific notation and is a special circumstance that occurs outside the Normal Flow of the Process. For this reason, the Compensation Intermediate Event does not have an outgoing Sequence Flow, but instead has an outgoing directed Association (see Figure 10.58).

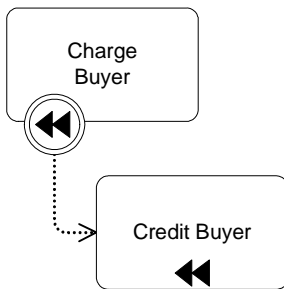

Figure 10.58 - A Task with an Associated Compensation Activity

The target of this Association is the activity that will compensate for the work done in the source activity, and will be referred to as the Compensation Activity. The Compensation Activity is special in that it does not follow the normal Sequence Flow rules--as mentioned, it is outside the Normal Flow of the Process. This activity cannot have any incoming or outgoing Sequence Flow. The Compensation marker (as is in the Compensation Intermediate Event) will be displayed in the bottom center of the Activity to show this status of the activity (see the “Credit Buyer” Task in Figure 10.58). Note that there can be only one target activity for compensation. There cannot be a sequence of activities shown. If the compensation does require more than one activity, then these activities must be put inside a single Sub-Process that is the target of the Association. The Sub-Process can be collapsed or expanded. If the Sub-Process is expanded, then only the Sub-Process itself requires the Compensation marker--the activities inside the Sub-Process do not require this marker.

Only activities that have been completed can be compensated. The compensation of an activity can be triggered in two ways:

- The activity is inside a Transaction Sub-Process that is cancelled (see Figure 10.59). In this situation, the whole Sub-Process will be “rewound” or rolled back--the Process flow will go backwards and any activity that requires compensation will be compensated. This is why the Compensation marker for Events looks like a “rewind” symbol for a tape player. After the compensation has been completed, the Process will continue its rollback.
- A downstream Intermediate or End Event of type Compensation “throws” a compensation identifier that is “caught” by the Intermediate Event attached to the boundary of the activity.

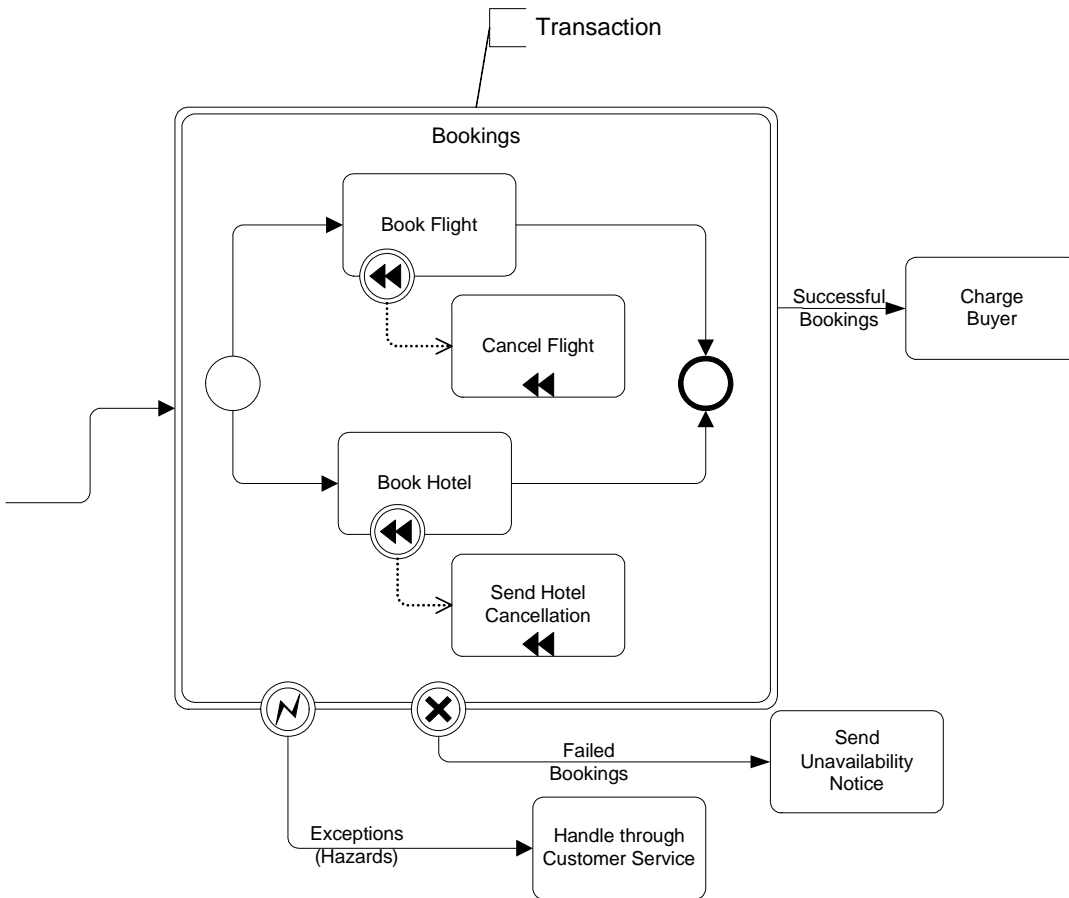

Figure 10.59 - Compensation Shown in the context of a Transaction

11 Mapping to BPEL4WS

This section will cover a mapping to BPEL4WS that are derived by analyzing the BPMN objects and the relationships between these objects as described in the previous chapters.

11.1 Business Process Diagram Mappings

A Business Process Diagram can be made up of a set of (semi-) independent components, which are shown as separate Pools. Thus, there is not a specific mapping to the diagram itself. Rather, there are separate mappings to each of the Pools that are in the diagram. That is, each Pool in the diagram, if it is a “white box” that contains process elements, will map to an individual BPEL4WS *process*. However, in the course of mapping the contents of the Process, there may be one or more derived *processes* necessary to handle complex behavior, such as looping. The attributes of “black box” Pools will also be used in determining specific BPEL4WS elements, such as *partnerLink*.

The following table displays a set of mappings for the attributes of a Business Process Diagram that can be mapped to BPEL4WS:

Table 11.1 - Business Process Diagram Mappings to BPEL4WS

| Business Process Diagram | Mapping to BPEL4WS |
|--|--|
| Id, Name, Version, Author, Language, CreationDate, ModificationDate, Pool, and Documentation | These Elements do not map to any BPEL4WS elements or attributes. |
| ExpressionLanguage attribute | This attribute will be used for all the Processes that are within the Business Process Diagram. The attribute will map to the <i>expressionLanguage</i> attribute of each BPEL4WS <i>process</i> . |
| QueryLanguage attribute | This attribute will be used for all the Processes that are within the Business Process Diagram. The attribute will map to the <i>queryLanguage</i> attribute of each BPEL4WS <i>process</i> . |

11.2 Business Process Mappings

There can be one or more Business Processes within a Business Process Diagram, each within a separate Pool. The following table displays a set of mappings from attributes of a Process to BPEL4WS elements (the mappings for the objects contained within a Process, its contents, are mapped separately and these mappings can be found in the sections that follow):

Table 11.2 Business Process Mappings to BPEL4WS

| Process | Mapping to BPEL4WS |
|-------------|---|
| ProcessType | If the Process is to be used to create a BPEL4WS document, then the attribute MUST be set to Private or Abstract. If the attribute is set to Private, then the <i>abstractProcess</i> attribute of the BPEL4WS <i>process</i> MUST be set to “no.” If the attribute is set to Abstract, then the <i>abstractProcess</i> attribute of the BPEL4WS <i>process</i> MUST be set to “yes.” |

Table 11.2 Business Process Mappings to BPEL4WS

| Process | Mapping to BPEL4WS |
|-----------------------------------|--|
| Id, Categories, and Documentation | These Elements do not map to any BPEL4WS elements or attributes. |
| Name | The Name attribute of the Process SHALL map to <i>name</i> attribute of the appropriate <i>process</i> . The extra spaces and non-alphanumeric characters MUST be stripped from the Name to fit with the XML specification of the <i>name</i> attribute. Note that there may be two or more elements with the same name after the BPMN name has been stripped. |
| GraphicalElements | This is a list of all the graphical elements contained within the Process. Each of these elements will have their mapping, as defined in the sections below. |
| Properties | <p>The set of Properties of a Process, as a whole, will map to a BPEL4WS <i>variable</i>. The <i>variable</i> element will be structured as follows:</p> <pre><variable name="[Process.Name]_Data" messageType="[Process.Name]_ProcessDataMessage" /></pre> <p>The individual Properties will map to the <i>parts</i> of a WSDL <i>message</i>. The <i>message</i> element will be structured as follows:</p> <pre><message name="[Process.Name]_ProcessDataMessage" > <part name="[Property.Name]" type="xsd:[Property.Type]" /> </message></pre> <p>There will be as many <i>parts</i> to the <i>message</i> as there are Properties in the input group.</p> |
| Correlation = True | <p>This only applies to Properties of Type = "Set."</p> <p>The Name of the Property will map to the name of a <i>correlationSet</i>. The Name of each child Property for the Set will be added to the list of <i>properties</i> of the <i>correlationSet</i>.</p> |
| Adhoc | Ad Hoc Processes are not executable. Thus, this attribute MUST be set to False if the Process is to be mapped to BPEL4WS. |
| AdHocCompletionCondition | This attribute only applies to Ad Hoc Processes. Thus, it will not be mapped to BPEL4WS. |
| With Assignments Expression | This will map to a BPEL4WS <i>assign</i> . Refer to the section entitled "Assignment Mapping" on page 189 for more details about the mappings associated with the <i>assign</i> element. |
| AssignTime = Start | A BPEL4WS <i>sequence</i> will be created and the <i>assign</i> will follow the instantiation of the process (through a <i>receive</i> or a <i>pick</i>). |
| AssignTime = End | A BPEL4WS <i>sequence</i> will be created and the <i>assign</i> will follow |
| SuppressJoinFailure | This maps to the BPEL4WS <i>process</i> attribute <i>suppressJoinFailure</i> . |
| EnableInstanceCompensation | This maps to the BPEL4WS <i>process</i> attribute <i>enableInstanceCompensation</i> . |

- ◆ The BPEL4WS *process* attributes *targetNamespace* and *xmlns* MUST be provided by the modeling tool that generates the mapping to BPEL4WS.

11.3 Common Flow Object Mappings

The following table displays a set of mappings for the attributes common to Flow Objects (Events, Activities, and Gateways):

Table 11.3 - Common Flow Object Attribute Mappings to BPEL4WS

| Objects | Mapping to BPEL4WS |
|--|---|
| Id, Pool, Lanes, Categories, and Documentation | These Elements do not map to any BPEL4WS elements or attributes. |
| Name | The Name attribute of the object SHALL map to <i>name</i> attribute of the appropriate derived BPEL4WS element (as per mappings described in the sections below). The extra spaces and non-alphanumeric characters MUST be stripped from the Name to fit with the XML specification of the <i>name</i> attribute. Note that there may be two or more elements with the same name after the BPMN name has been stripped. |
| Assignments | Each Assignments Expression will map to a BPEL4WS <i>assign</i> activity. Refer to the section entitled “Assignment Mapping” on page 189 for more details about the mappings associated with the <i>assign</i> element. |

11.4 Events

11.4.1 Start Event Mappings

The following table displays a set of mappings from the variations of a Start Event to BPEL4WS elements (these mappings extend the mappings common to objects--see Section 11.3, “Common Flow Object Mappings,” on page 139):

Table 11.4 - Start Event Mappings to BPEL4W

| Start Event | Mapping to BPEL4WS |
|-------------------------------|--|
| EventType = Start and Trigger | The mapping to BPEL4WS is specific to the Trigger setting. These mappings are defined in the rows below. |
| None | There is no BPEL4WS element that a Start Event will map to with a Trigger that is None. The object(s) that are the Target(s) of Sequence Flow that originate from the Start Event will determine the first BPEL4WS element of the Process. Note that a valid BPEL4WS <i>process</i> must begin with a <i>receive</i> or a <i>pick</i> activity that has a <i>createInstance</i> set to “yes.” The <i>receive</i> or <i>pick</i> will likely be placed within a <i>sequence</i> or a <i>flow</i> . |
| Message | This will map to the <i>receive</i> element. The <i>createInstance</i> attribute of the <i>receive</i> element will be set to “yes.” |
| Message | The Message attribute maps to the <i>variable</i> attribute of the <i>receive</i> activity. See “Messages” on page 189 for more information about how a BPMN Message maps to BPEL4WS and WSDL. |

Table 11.4 - Start Event Mappings to BPEL4W

| Start Event | Mapping to BPEL4WS |
|------------------------------|--|
| Implementation = Web Service | <p>The Implementation attribute MUST be a Web service or MUST be converted to a Web Service for mapping to BPEL4WS. The Web Service Attributes are mapped as follows:</p> <p>The Participant attribute is mapped to the <i>partnerLink</i> attribute of the BPEL4WS activity.</p> <p>The Interface attribute is mapped to the <i>portType</i> attribute of the BPEL4WS activity.</p> <p>The Operation attribute is mapped to the <i>operation</i> attribute of the BPEL4WS activity.</p> |
| Timer | <p>This will map to the <i>receive</i> element. The <i>createInstance</i> attribute of the <i>receive</i> element will be set to “yes.” The remaining attributes of the <i>receive</i> will be mapped as shown for the Message Start Event (see above).</p> <p>The functionality of the timing as defined in the Start Event must be implemented in a separate process that will start itself, then use a <i>wait</i> element for the defined time, and then use an <i>invoke</i> to send a message that will be received by the above <i>receive</i> element. A specific Message and Web service implementation must be provided so that the mappings to <i>receive</i> element can be completed.</p> |
| Rule | <p>This will map to the <i>receive</i> element. The <i>createInstance</i> attribute of the <i>receive</i> element will be set to “yes.” The remaining attributes of the <i>receive</i> will be mapped as the same way as for the Message Start Event (see above).</p> <p>Note: the Message is expected to arrive from the application that tracks and triggers Business Rules.</p> |
| Link | <p>This will map to the <i>receive</i> element. The <i>createInstance</i> attribute of the <i>receive</i> element will be set to “yes.” The remaining attributes of the <i>receive</i> will be mapped as shown for the Message Start Event (see above). A specific Message and Web service implementation must be provided so that the mappings to <i>receive</i> element can be completed.</p> |
| Multiple | <p>This will map to a BPEL4WS <i>pick</i> will be required to process the messages with a separate <i>onMessage</i> for each defined Trigger. The <i>createInstance</i> attribute of the <i>pick</i> element will be set to “yes.” This means that a single instance of the process will be instantiated when the first message received through the <i>pick onMessage</i> is triggered. The <i>onMessage</i> mappings are the same as that of a <i>receive</i> and as defined for the Message Start Event (see above).</p> |
| With Assignments Expression | <p>Each Assignments Expression will map to a BPEL4WS <i>assign</i> that will follow the <i>receive</i>. See Section 11.15, “Assignment Mapping,” on page 189 for more details about the mappings associated with the <i>assign</i> element.</p> |

Changes Since 1.0 Draft Version

These are the changes since the last publicly released version:

- The Timer and Rule Trigger mappings have been defined.
- The definition of the Link Trigger mapping was expanded.

- The mapping for the Multiple Trigger was changed to be a BPEL4WS *pick* element.
- The part of the definition of the Message Trigger that described the mapping if there were multiple incoming Message Flow was removed. This was due that only Multiple Triggers can have multiple incoming Message Flow.

11.4.2 End Event Mappings

The following table displays a set of mappings from the variations of a End Event to BPEL4WS elements (these mappings extend the mappings common to objects--see Section 11.3, “Common Flow Object Mappings,” on page 139):

Table 11.5 - End Event Mappings to BPEL4WS

| End Event | Mapping to BPEL4WS |
|------------------------------|--|
| EventType = End and Result | The mapping to BPEL4WS is specific to the Result setting. These mappings are defined in the rows below. |
| None | There is no BPEL4WS element that a End Event will map to with a Result that is None. However, it marks the end of a path within the Process and will be used to define the boundaries of complex BPEL4WS elements. The object(s) that are the Source(s) of Sequence Flow that Target the End Event will determine the final BPEL4WS elements of the Process. |
| Message | This will map to a BPEL4WS <i>reply</i> or an <i>invoke</i> . The appropriate BPEL4WS activity will be determined by the implementation defined for the Event. That is, the <i>portType</i> and <i>operation</i> of the Message will be used to check to see if an upstream Message Event have the same <i>portType</i> and <i>operation</i> . If these two attributes are matched, then the Event will map to a <i>reply</i> , if not, the Event will map to an <i>invoke</i> . |
| Message | The Message attribute maps to the <i>variable</i> attribute of the <i>reply</i> or the <i>outputVariable</i> of the <i>invoke</i> . See “Messages” on page 189 for more information about how a BPMN Message maps to BPEL4WS and WSDL. |
| Implementation = Web Service | The Implementation attribute MUST be a Web service or MUST be converted to a Web Service for mapping to BPEL4WS. The Web Service Attributes are mapped as follows: The Participant attribute is mapped to the <i>partnerLink</i> attribute of the BPEL4WS activity. The Interface attribute is mapped to the <i>portType</i> attribute of the BPEL4WS activity. The Operation attribute is mapped to the <i>operation</i> attribute of the BPEL4WS activity. |
| Error | This will map to a <i>throw</i> element. The ErrorCode attribute of the Event will map to the <i>faultName</i> attribute of the <i>throw</i> . |
| Cancel | The mapping of the Cancel Intermediate Event to BPEL4WS is an open issue. Refer to Annex D for other Open Issues. |
| Compensation | This will map to a <i>compensate</i> element. The Name of the activity referenced by the Compensation Event will map to the <i>scope</i> attribute of the <i>compensate</i> element. |
| Link | This will map to a (one-way) <i>invoke</i> element. |
| LinkId | The LinkId attribute maps to the <i>outputVariable</i> of the <i>invoke</i> . See “Messages” on page 189 for more information about how a BPMN Message maps to BPEL4WS and WSDL. |

Table 11.5 - End Event Mappings to BPEL4WS

| End Event | Mapping to BPEL4WS |
|-----------------------------|---|
| ProcessRef | The Implementation attribute MUST be a Web service or MUST be converted to a Web Service for mapping to BPEL4WS. The Web Service Attributes are mapped as follows: The Participant attribute of the Pool where the Process is contained is mapped to the <i>partnerLink</i> attribute of the BPEL4WS activity. The Name attribute of the Process is mapped to the <i>portType</i> attribute of the BPEL4WS activity. The LinkId attribute is mapped to the <i>operation</i> attribute of the BPEL4WS activity. |
| Terminate | This will map to the <i>terminate</i> element. |
| Multiple | This will map to a combination of <i>invoke</i> , <i>throw</i> , <i>fault</i> , and <i>compensation</i> elements as they are defined above. |
| With Assignments Expression | This will map to a BPEL4WS <i>assign</i> that will precede any other mappings required by the Event. See Section 11.15, “Assignment Mapping,” on page 189 for more details about the mappings associated with the <i>assign</i> element. |

Changes Since 1.0 Draft Version

These are the changes since the last publicly released version:

- The mapping for the Message, Error, Compensation, and Link End Events was updated and expanded.
- The mapping to the Return End Event was removed, since that type of Event has been removed.

11.4.3 Intermediate Event Mappings

The following table displays a set of mappings from the variations of a Intermediate Event to BPEL4WS elements (these mappings extend the mappings common to objects--see Section 11.3, “Common Flow Object Mappings,” on page 139):

Table 11.6 - Intermediate Event Mappings to BPEL4WS

| Intermediate Event | Mapping to BPEL4WS |
|--------------------------------------|--|
| EventType = Intermediate and Trigger | The mapping to BPEL4WS is specific to the Trigger setting. These mappings are defined in the sections below. |
| With Assignments Expression | this will map to a BPEL4WS <i>assign</i> . See Section 11.15, “Assignment Mapping,” on page 189 for more details about the mappings associated with the <i>assign</i> element. |

None Intermediate Events

The mappings for None Intermediate Events are described in the following table (these mappings extend the mappings common to Intermediate Events--see Section 11.4.3, “Intermediate Event Mappings,” on page 142):

Table 11.7 - None Intermediate Mappings to BPEL4WS

| Intermediate Event | Mapping to BPEL4WS |
|--------------------|--|
| Trigger = None | There is no BPEL4WS element that a Intermediate Event will map to with a Trigger that is None. These types of Intermediate Events are often used for documentation purposes to show a specific state of the Process. |

Message Intermediate Events

The mappings for Message Intermediate Events are described in the following table (these mappings extend the mappings common to Intermediate Events--refer to the section entitled “Intermediate Event Mappings” on page 142):

Table 11.8 - Message Intermediate Mappings to BPEL4WS

| Intermediate Event | Mapping to BPEL4WS |
|--|--|
| Trigger = Message | This mapping is defined in the next five (5) rows. |
| Within the Normal Flow | If the Participant defined in the To attribute of the Message is the same Participant as that of the Process that contains the Event, then this will map to a <i>receive</i> . The <i>createInstance</i> attribute of the <i>receive</i> element will be set to “no.” If the Participant defined in the From attribute of the Message is the same Participant as that of the Process that contains the Event, then this will map to a (one-way) <i>invoke</i> . |
| Message | The Message attribute maps to the <i>variable</i> attribute of the <i>reply</i> or the <i>outputVariable</i> of the <i>invoke</i> . See “Messages” on page 189 for more information about how a BPMN Message maps to BPEL4WS and WSDL. |
| Implementation = Web Service | The Implementation attribute MUST be a Web service or MUST be converted to a Web Service for mapping to BPEL4WS. The Web Service Attributes are mapped as follows: The Participant attribute is mapped to the <i>partnerLink</i> attribute of the BPEL4WS activity. The Interface attribute is mapped to the <i>portType</i> attribute of the BPEL4WS activity. The Operation attribute is mapped to the <i>operation</i> attribute of the BPEL4WS activity. |
| Without an incoming Sequence Flow (but not attached to an Activity Boundary) | The Participant defined in the To attribute of the Message MUST be the same Participant as that of the Process that contains the Event. The <i>process</i> will be given a <i>scope</i> (if it doesn’t already have one). A <i>eventHandlers</i> element will be defined for the <i>scope</i> . An <i>onMessage</i> element will be added to the <i>eventHandlers</i> element. |
| Message | The Message attribute maps to the <i>variable</i> attribute of the <i>onMessage</i> . See “Messages” on page 189 for more information about how a BPMN Message maps to BPEL4WS and WSDL. |
| Implementation = Web Service | The Implementation attribute MUST be a Web service or MUST be converted to a Web Service for mapping to BPEL4WS. The Web Service Attributes are mapped as follows: The Participant attribute is mapped to the <i>partnerLink</i> attribute of the <i>onMessage</i> . The Interface attribute is mapped to the <i>portType</i> attribute of the <i>onMessage</i> . The Operation attribute is mapped to the <i>operation</i> attribute of the <i>onMessage</i> . |

Table 11.8 - Message Intermediate Mappings to BPEL4WS

| Intermediate Event | Mapping to BPEL4WS |
|----------------------------------|---|
| Attached to an Activity Boundary | <p>The mappings of the activity (to which the Event is attached) will be placed within a <i>scope</i>.</p> <p>A <i>faultHandlers</i> element will be defined for the <i>scope</i>.</p> <p>A <i>catch</i> element will be added to the <i>faultHandlers</i> element with “<message name>_Exit” as the <i>faultName</i> attribute.</p> <p>An <i>eventHandlers</i> element will be defined for the <i>scope</i>.</p> <p>The Event will map to an <i>onMessage</i> element within the <i>eventHandlers</i>. The mapping to the <i>onMessage</i> attributes is the same as described for the <i>receive</i> above.</p> <p>The activity for the <i>onMessage</i> will be a <i>throw</i> with “<message name>_Exit” as the <i>faultName</i> attribute.</p> |
| Used in an Event-Based Decision | <p>This will map to an <i>onMessage</i> within a <i>pick</i>. The mapping to the <i>onMessage</i> attributes is the same as described for the <i>receive</i> above.</p> |

Timer Intermediate Events

The mappings for Timer Intermediate Events are described in the following table (these mappings extend the mappings common to Intermediate Events--see Section 11.4.3, “Intermediate Event Mappings,” on page 142):

Table 11.9 - Timer Intermediate Mappings to BPEL4WS

| Intermediate Event | Mapping to BPEL4WS |
|--|--|
| Trigger = Timer | <p>This mapping is defined in the next three (3) rows.</p> |
| Within the Normal Flow | <p>This will map to a <i>wait</i>.</p> <p>The <i>TimeDate</i> attribute maps to the <i>until</i> attribute of the <i>wait</i>.</p> <p>The <i>TimeCycle</i> attribute maps to the <i>for</i> attribute of the <i>wait</i>.</p> |
| Without an incoming Sequence Flow (but not attached to an Activity Boundary) | <p>The <i>process</i> will be given a <i>scope</i> (if it doesn’t already have one).</p> <p>A <i>eventHandlers</i> element will be defined for the <i>scope</i>.</p> <p>An <i>onAlarm</i> element will be added to the <i>eventHandlers</i> element.</p> <p>The <i>TimeDate</i> attribute maps to the <i>until</i> attribute of the <i>onAlarm</i>.</p> <p>The <i>TimeCycle</i> attribute maps to the <i>for</i> attribute of the <i>onAlarm</i>.</p> |
| Attached to an Activity Boundary | <p>The mappings of the activity (to which the Event is attached) will be placed within a <i>scope</i>.</p> <p>A <i>faultHandlers</i> element will be defined for the <i>scope</i>.</p> <p>A <i>catch</i> element will be added to the <i>faultHandlers</i> element with “<Event name>_Exit” as the <i>faultName</i> attribute.</p> <p>An <i>eventHandlers</i> element will be defined for the <i>scope</i>.</p> <p>The Event will map to an <i>onAlarm</i> element within the <i>eventHandlers</i>.</p> <p>The <i>TimeDate</i> attribute maps to the <i>until</i> attribute of the <i>onAlarm</i>.</p> <p>The <i>TimeCycle</i> attribute maps to the <i>for</i> attribute of the <i>onAlarm</i>.</p> <p>The activity for the <i>onAlarm</i> will be a <i>throw</i> with “<message name>_Exit” as the <i>faultName</i> attribute.</p> |

Table 11.9 - Timer Intermediate Mappings to BPEL4WS

| Intermediate Event | Mapping to BPEL4WS |
|---------------------------------|--|
| Used in an Event-Based Decision | This will map to an <i>onAlarm</i> within a <i>pick</i> . The TimeDate attribute maps to the <i>until</i> attribute of the <i>onAlarm</i> . The TimeCycle attribute maps to the <i>for</i> attribute of the <i>onAlarm</i> . |

Error Intermediate Events

The mappings for Error Intermediate Events are described in the following table (these mappings extend the mappings common to Intermediate Events--see Section 11.4.3, “Intermediate Event Mappings,” on page 142):

Table 11.10 - Error Intermediate Mappings to BPEL4WS

| Intermediate Event | Mapping to BPEL4WS |
|----------------------------------|--|
| Trigger = Error | This mapping is defined in the next two (2) rows. |
| Within the Normal Flow | This will map to a <i>throw</i> element. |
| Attached to an Activity Boundary | The mappings of the activity (to which the Event is attached) will be placed within a <i>scope</i> . This Event will map to a <i>catch</i> element within a <i>scope</i> . If the Error Event does not have an ErrorCode, then a <i>catchAll</i> element will be added to the <i>faultHandlers</i> element. If the Error Event does has an ErrorCode, then a <i>catch</i> element will be added to the <i>faultHandlers</i> element with the ErrorCode mapping to the <i>faultName</i> attribute. |

Cancel Intermediate Events

The mappings for Cancel Intermediate Events are described in the following table (these mappings extend the mappings common to Intermediate Events--see Section 11.4.3, “Intermediate Event Mappings,” on page 142):

Table 11.11 - Cancel Intermediate Mappings to BPEL4WS

| Intermediate Event | Mapping to BPEL4WS |
|--------------------|---|
| Trigger = Cancel | The mapping of the Cancel Intermediate Event to BPEL4WS is an open issue. Refer to Annex D for other Open Issues. |

Rule Intermediate Events

The mappings for Rule Intermediate Events are described in the following table (these mappings extend the mappings common to Intermediate Events--see Section 11.4.3, “Intermediate Event Mappings,” on page 142):

Table 11.12 - Rule Intermediate Mappings to BPEL4WS

| Intermediate Event | Mapping to BPEL4WS |
|------------------------|---|
| Trigger = Rule | This mapping is defined in the next two (2) rows. |
| Within the Normal Flow | This will map to the <i>receive</i> element. The <i>createInstance</i> attribute of the <i>receive</i> element will be set to “no.” The remaining attributes of the <i>receive</i> will be mapped as shown for the Message Start Event (see above). |

Table 11.12 - Rule Intermediate Mappings to BPEL4WS

| Intermediate Event | Mapping to BPEL4WS |
|--|---|
| Without an incoming Sequence Flow (but not attached to an Activity Boundary) | <p>The Participant defined in the To attribute of the Message MUST be the same Participant as that of the Process that contains the Event.</p> <p>The <i>process</i> will be given a <i>scope</i> (if it doesn't already have one).</p> <p>A <i>eventHandlers</i> element will be defined for the <i>scope</i>.</p> <p>The Event will map to an <i>onMessage</i> element within the <i>eventHandlers</i>. The mapping to the <i>onMessage</i> attributes is the same as described for the <i>receive</i> for the Message Event above.</p> <p>Note: the Message is expected to arrive from the application that tracks and triggers Business Rules.</p> |
| Attached to an Activity Boundary | <p>The mappings of the activity (to which the Event is attached) will be placed within a <i>scope</i>.</p> <p>A <i>faultHandlers</i> element will be defined for the <i>scope</i>.</p> <p>A <i>catch</i> element will be added to the <i>faultHandlers</i> element with “<message name>_Exit” as the <i>faultName</i> attribute.</p> <p>An <i>eventHandlers</i> element will be defined for the <i>scope</i>.</p> <p>The Event will map to an <i>onMessage</i> element within the <i>eventHandlers</i>. The mapping to the <i>onMessage</i> attributes is the same as described for the <i>receive</i> for the Message Event above.</p> <p>Note: the Message is expected to arrive from the application that tracks and triggers Business Rules.</p> <p>The activity for the <i>onMessage</i> will be a <i>throw</i> with “<message name>_Exit” as the <i>faultName</i> attribute.</p> |
| Used in an Event-Based Decision | <p>This will map to an <i>onMessage</i> element within a <i>pick</i>. The mapping to the <i>onMessage</i> attributes is the same as described for the <i>receive</i> for the Message Event above.</p> |

Compensation Intermediate Events

The mappings for Compensation Intermediate Events are described in the following table (these mappings extend the mappings common to Intermediate Events--see Section 11.4.3, “Intermediate Event Mappings,” on page 142):

Table 11.13 - Compensation Intermediate Mappings to BPEL4WS

| Intermediate Event | Mapping to BPEL4WS |
|----------------------------------|--|
| Trigger = Compensation | This mapping is defined in the next two (2) rows. |
| Within the Normal Flow | This will map to a <i>compensate</i> element. The Name of the activity referenced by the Compensation Event will map to the <i>scope</i> attribute of the <i>compensate</i> element. |
| Attached to an Activity Boundary | The activity (to which the Event is attached) will be placed within a <i>scope</i> . This Event map to an <i>compensationHandler</i> element within a <i>scope</i> . |

Link Intermediate Events

The mappings for Link Intermediate Events are described in the following table (these mappings extend the mappings common to Intermediate Events--see Section 11.4.3, “Intermediate Event Mappings,” on page 142):

Table 11.14 - Link Intermediate Mappings to BPEL4WS

| Intermediate Event | Mapping to BPEL4WS |
|----------------------------------|--|
| Trigger = Link | This mapping is defined in the next four (4) rows. |
| With an outgoing Sequence Flow | This will map to a <i>receive</i> . The <i>createInstance</i> attribute of the <i>receive</i> element will be set to “no.” The mapping to the <i>receive</i> attributes is the same as described for the <i>receive</i> for the Message Event above. |
| With an incoming Sequence Flow | This will map to a (one-way) <i>invoke</i> element. The mapping to the <i>onMessage</i> attributes is the same as described for the <i>invoke</i> for the Message Event above. |
| Attached to an Activity Boundary | The mappings of the activity (to which the Event is attached) will be placed within a <i>scope</i> . A <i>faultHandlers</i> element will be defined for the <i>scope</i> . A <i>catch</i> element will be added to the <i>faultHandlers</i> element with “<message name>_Exit” as the <i>faultName</i> attribute. An <i>eventHandlers</i> element will be defined for the <i>scope</i> . The Event will map to an <i>onMessage</i> element within the <i>eventHandlers</i> . The mapping to the <i>onMessage</i> attributes is the same as described for the <i>receive</i> for the Message Event above. The activity for the <i>onMessage</i> will be a <i>throw</i> with “<message name>_Exit” as the <i>faultName</i> attribute. |
| Used in an Event-Based Decision | This will map to an <i>onMessage</i> element within a <i>pick</i> . The mapping to the <i>onMessage</i> attributes is the same as described for the <i>receive</i> for the Message Event above. |

Multiple Intermediate Events

The mappings for Multiple Intermediate Events are described in the following table (these mappings extend the mappings common to Intermediate Events--see Section 11.4.3, “Intermediate Event Mappings,” on page 142):

Table 11.15 - Multiple Intermediate Mappings to BPEL4WS

| Intermediate Event | Mapping to BPEL4WS |
|--------------------|---|
| Trigger = Multiple | This will map to a this will map to a combination of the mappings as they are defined in the Intermediate Event sections above. |

Changes Since 1.0 Draft Version

These are the changes since the last publicly released version:

- The mapping for the Message, Error, Compensation, Rule, and Link End Events was updated and expanded.

11.5 Activities

11.5.1 Common Activity Mappings

The following table displays a set of mappings from the variations of activities to BPEL4WS elements (these mappings extend the mappings common to objects -- see Section 11.3, “Common Flow Object Mappings,” on page 139 -- Note that Table 11.17 contains additional mappings that must be included within this set if extended by any other mapping table):

Table 11.16 - Common Activity Mappings to BPEL4WS

| Activity | Mapping to BPEL4WS |
|-----------------------------|---|
| Properties | <p>The set of Properties of an activity, as a whole, will map to a BPEL4WS <i>variable</i>. The <i>variable</i> element will be structured as follows:</p> <pre><variable name="[activity.Name]_ActivityData" messageType="[activity.Name]_ActivityDataMessage" /></pre> <p>The individual Properties will map to the <i>parts</i> of a WSDL <i>message</i>. The <i>message</i> element will be structured as follows:</p> <pre><message name="[activity.Name]_ActivityDataMessage" > <part name="[Property.Name]" type="xsd:[Property.Type]" /> </message></pre> <p>There will be as many <i>parts</i> to the <i>message</i> as there are Properties in the input group.</p> |
| With Assignments Expression | This will map to a BPEL4WS <i>assign</i> . Refer to the section entitled “Assignment Mapping” on page 189 for more details about the mappings associated with the <i>assign</i> element. |
| AssignTime = Start | A BPEL4WS sequence will be created and the <i>assign</i> will precede |
| AssignTime = End | A BPEL4WS sequence will be created and the <i>assign</i> will follow |

Activity Loop Mapping

The mapping to BPEL4WS for looping activities is complex and is made up of a number of activities that will surround the original mapping of the activity itself (which may be complex). The description of this mapping is divided into three sections to describe the basic setup of the loop (common to all loops), then the details of Standard looping, then the details of Multi-Instance looping.

Basic Loop Setup

The basic set up mappings, which are common to both Standard and Multi-Instance looping activities, are described in the following table (these mappings extend the mappings common to objects--see Section 11.5.1, “Common Activity Mappings,” on page 148):

Table 11.17 - Basic Activity Loop Mappings to BPEL4WS

| Looping | Mapping to BPEL4WS |
|----------------------------------|---|
| Activities with internal looping | Activities that have either a Standard or MultiInstance loop setting will result in a pattern of BPEL4WS elements, depending on the exact settings. This pattern will be placed within a BPEL4WS <i>sequence</i> activity. The details of the other mappings are described in the rows that follow. |

Table 11.17 - Basic Activity Loop Mappings to BPEL4WS

| Looping | Mapping to BPEL4WS |
|-----------------------------------|--|
| LoopCounter | <p>This attribute will map to a BPEL4WS <i>variable</i>, which will be part of the <i>process</i> definition. The variable will be structured as follows:</p> <pre data-bbox="496 474 1145 527"><variable name="[activity.Name]_loopCounter" messageType="loopCounterMessage" /></pre> <p>Note: The LoopCounter mappings described in the this and the next three rows are only required for Multi-Instance loops and Standards loops that use the LoopMaximum attribute. For all looping activities, the LoopCounter can be used for reporting purposes.</p> |
| Supporting WSDL Message | <p>A WSDL <i>message</i> element will have to be created to support this <i>variable</i>. This <i>message</i> can be used for multiple <i>variables</i>. The <i>message</i> will be structured as follows:</p> <pre data-bbox="496 743 1185 821"><message name="loopCounterMessage" > <part name="loopCounter" type="xsd:integer" /> </message></pre> |
| Initialization of the LoopCounter | <p>An <i>assign</i> activity will be created to initialize the <i>variable</i> before the start of the loop. This activity precede the <i>while</i> activity. This will be the first activity within the <i>sequence</i> activity. The <i>assign</i> will be structured as follows:</p> <pre data-bbox="496 940 1278 1125"><assign name="[activity.Name]_initialize_loopCounter"> <copy> <from expression="0"/> <to variable="[activity.Name]_loopCounter" part="loopCounter" /> </copy> </assign></pre> |
| Incrementing the LoopCounter | <p>An <i>assign</i> activity will be created to update the loopCounter <i>variable</i> at the end of the <i>while</i> activity (see below). This activity will the last activity of the <i>sequence</i> activity that is within the <i>while</i> activity. The <i>assign</i> will be structured as follows:</p> <pre data-bbox="496 1247 1321 1482"><assign name="[activity.Name]_increment_loopCounter"> <copy> <from expression=" bpws:getVariableData([activity.Name]_loopCounter, loopCount) + 1"/> <to variable="[activity.Name]_loopCounter" part="loopCounter" /> </copy> </assign></pre> |

Standard Loops

The loop mappings for Standard loops are described in the following table (these mappings extend the mappings of the Basic Loop Setup--refer to the previous section):

Table 11.18 - Standard Activity Loop Mappings to BPEL4WS

| Looping | Mapping to BPEL4WS |
|---------------------|--|
| LoopType = Standard | For a Standard Looping activity, the mapping of the base BPMN activity will be placed within a BPEL4WS <i>sequence</i> that is within a <i>while</i> , and this will follow the <i>assign</i> described in the Basic Loop Setup (see Figure 11.1 and Example 11.1). Section 11.5.2, “Sub-Process Mappings,” on page 166 or the Section 11.5.3, “Task Mappings,” on page 168 for details about how the base activity will be mapped to BPEL4WS. |
| LoopCondition | The LoopCondition, which MUST be a boolean expression, will be used as the <i>condition</i> attribute of the <i>while</i> element. The <i>while condition</i> be structured as follows: <pre><while condition=" [loopCondition] "></pre> |
| TestTime = After | An After TestTime will map to the BPEL4WS <i>while</i> activity. However, to insure that the Task is performed at least once (i.e., the functionality of an until loop), a copy of the mapping for BPMN activity will be performed first in a <i>sequence</i> , followed by the <i>while</i> (which will contain the original copy of the mapping for the BPMN activity). |
| TestTime = Before | A Before TestTime does not require any additional mappings. |
| LoopMaximum | Any value in Maximum will be appended to the LoopCondition. For example with a LoopCondition of “x < 0” and Maximum of 5 (loops), the final expression would be “(x < 0) and ([ActivityName].LoopCounter <= 5).” |

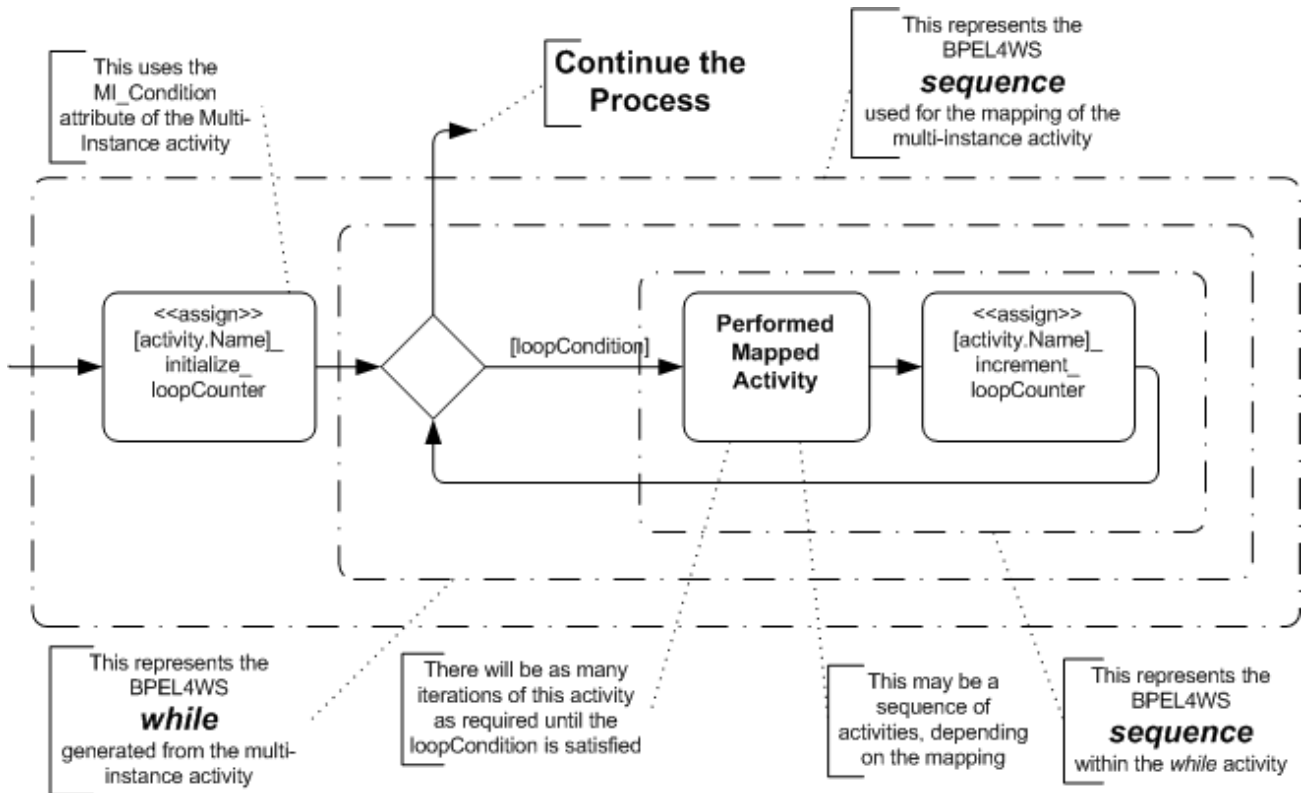

Figure 11.1 - BPMN Depiction of BPEL4WS Pattern for a Standard loop, TestTime = Before

Example 11.1 displays sample BPEL4WS code that reflects the mapping of a Standard loop.

```

<!-- The Process data is defined first-->
<variable name="[activity.Name]_loopCounter" messageType="loopCounterMessage" />
<!-- The contents of the process prior to the looping activity are here-->
<sequence>
  <assign name="[activity.Name]_initialize_loopCounter">
    <copy>
      <from expression="0"/>
      <to variable="[activity.Name]_loopCounter" part="loopCounter" />
    </copy>
  </assign>
  <!-- If the TestTime is set to After, the mappings of the original activity
       are placed here, as well as within the while.-->
  <while condition="[loopCondition]">
    <sequence>

      <!--The mappings of the original activity are placed here.-->

      <assign name="[activity.Name]_increment_counter">
        <copy>
          <from expression="bpws:getVariableData([activity.Name]_loopCounter,loopCount)+1"/>
          <to variable="[activity.Name]_loopCounter" part="loopCounter" />
        </copy>
      </assign>
    </sequence>
  </while>
</sequence>
<!-- The contents of the process after the looping activity are here-->

```

Example 11.1 - BPEL4WS Sample for a Standard Loop

Multi-Instance Loop Setup

The loop mappings for Multi-Instance loops are described in the following table (these mappings extend the mappings of the Basic Loop Settings--see “Basic Loop Setup” on page 148):

Table 11.19 - Multi-Instance Activity Loop Setup Mappings to BPEL4WS

| Multi-Instance | Mapping to BPEL4WS |
|--------------------------|---|
| LoopType = MultiInstance | For a Multi-Instance Looping activity, the mapping of the BPMN activity will be placed within a BPEL4WS <i>sequence</i> that is within a <i>while</i> , and this will follow the <i>assign</i> described in the Basic Loop Setup (see Figure 11.1 and Example 11.1). See Section 11.5.2, “Sub-Process Mappings,” on page 166 or Section 11.5.3, “Task Mappings,” on page 168 for details about how the base activity will be mapped to BPEL4WS. |

Table 11.19 - Multi-Instance Activity Loop Setup Mappings to BPEL4WS

| Multi-Instance | Mapping to BPEL4WS |
|------------------------------------|--|
| MI_Condition | <p>This applies to both Sequential and Parallel MI_Ordering (see below). The MI_Condition, which MUST be a numeric expression, will map to an <i>assign</i> activity. This will be the first activity of the generated <i>sequence</i> activity (as described in the row above).</p> <p>First, a BPEL4WS <i>variable</i> must be created with a derived name and will have a structure as follows:</p> <pre data-bbox="496 611 1185 663"><variable name="[activity.Name]_forEachCount" messageType="forEachCounterMessage" /></pre> <p>Second, an <i>assign</i> activity will be used to generate the number of instances that will be required. The <i>assign</i> will be structured as follows:</p> <pre data-bbox="496 768 1233 951"><assign name="[activity.Name]_determine_instances"> <copy> <from expression="[MI_Condition Expression]" /> <to variable="[activity.Name]_forEachCount" part="forEachCount" /> </copy> </assign></pre> |
| Supporting WSDL Message | <p>A WSDL <i>message</i> element will have to be created to support the <i>variable</i>. This <i>message</i> can be used for multiple <i>variables</i>. The <i>message</i> will be structured as follows:</p> <pre data-bbox="496 1041 1201 1115"><message name="forEachCounterMessage" > <part name="forEachCount" part="xsd:integer" /> </message></pre> |
| The condition for the <i>while</i> | <p>The <i>condition</i> attribute of the <i>while</i> will be a derived expression that utilizes the loopCounter variable and compares it to the derived forEachCount (described in the row above). The <i>while condition</i> be structured as follows:</p> <pre data-bbox="496 1241 1302 1367"><while condition=" bpws:getVariableData([activity.Name]_loopCounter, loopCounter) >= bpws:getVariableData([activity.Name]_forEachCount, forEachCount)"></pre> |

Sequential Multi-Instance Loops

The loop mappings for Sequential Multi-Instance loops are described in the following table (these mappings extend the mappings of the Multi-Instance Setup--refer to the section above):

Table 11.20 - Sequential Multi-Instance Activity Loop Mappings to BPEL4WS

| Multi-Instance | Mapping to BPEL4WS |
|--------------------------|---|
| MI_Ordering = Sequential | <p>This type of looping utilizes both the Basic Loop Setup mappings and the above Multi-Instance mappings. No further mappings are necessary. See Figure 11.2 and Example 11.2 for the complete mappings.</p> |

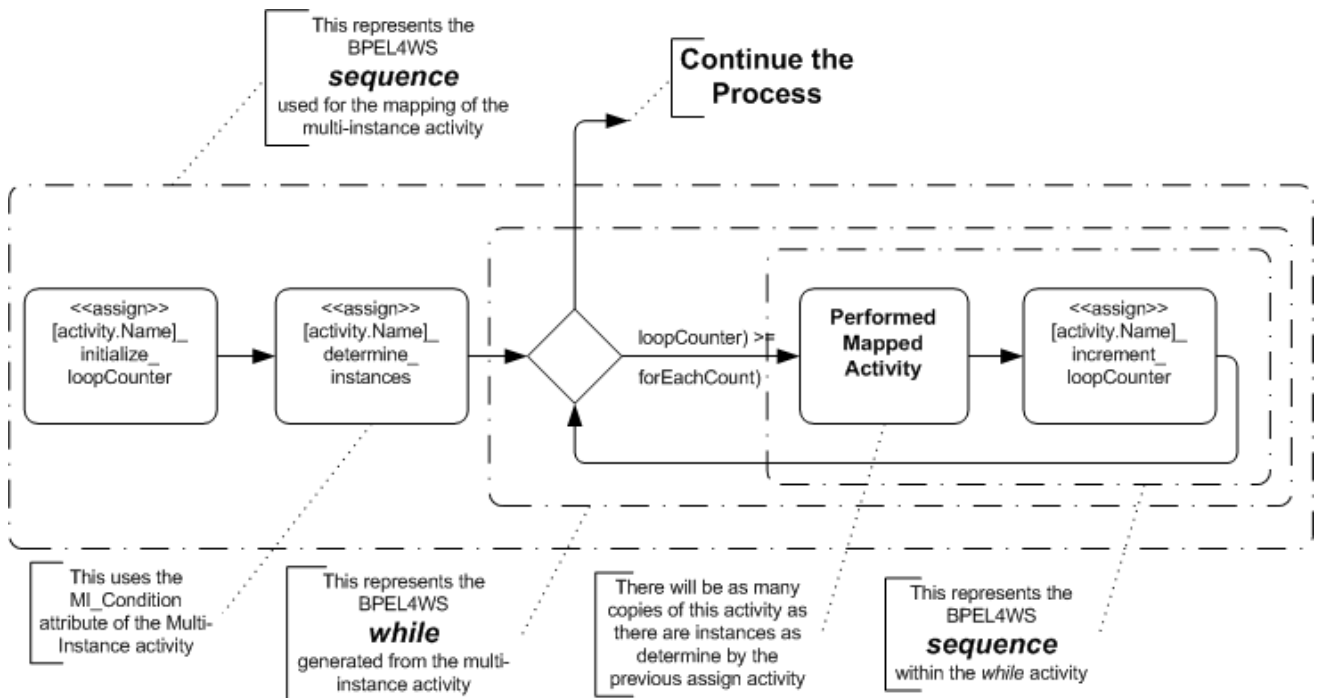

Figure 11.2 - BPMN Depiction of BPEL4WS Pattern for a Sequential Multi-Instance loop

Example 11.2 displays some sample BPEL4WS code that reflects the mapping of a Standard loop.

```
<!-- The Process data is defined first-->
<variable name="[activity.Name]_loopCounter" messageType="loopCounterMessage" />
<variable name="[activity.Name]_forEachCount" messageType="forEachCounterMessage" />
<!-- The contents of the process prior to the looping activity are here-->
<sequence>
  <assign name="[activity.Name]_initialize_loopCounter">
    <copy>
      <from expression="0"/>
      <to variable="[activity.Name]_loopCounter" part="loopCounter" />
    </copy>
  </assign>
  <assign name="[activity.Name]_determine_instances">
    <copy>
      <from expression="[MI_Condition Expression]"/>
      <to variable="[activity.Name]_forEachCount" part="forEachCount" />
    </copy>
  </assign>
  <while condition="bpws:getVariableData([activity.Name]_loopCounter,loopCounter) >=
    bpws:getVariableData([activity.Name]_forEachCount,forEachCount)">
    <sequence>

      <!--The mappings of the original activity are placed here.-->

      <assign name="[activity.Name]_increment_counter">
        <copy>
          <from expression="bpws:getVariableData([activity.Name]_loopCounter,loopCount)+1"/>
          <to variable="[activity.Name]_loopCounter" part="loopCounter" />
        </copy>
      </assign>
    </sequence>
  </while>
</sequence>
<!-- The contents of the process after the looping activity are here-->
```

Example 11.2 - BPEL4WS Sample for a Multi-Instance Loop with Sequential Ordering

Parallel Multi-Instance Loop Setup

The loop mappings for Sequential Multi-Instance loops are described in the following table (these mappings extend the mappings of the Multi-Instance Setup--refer to the section above):

Table 11.21 - Parallel Multi-Instance Activity Loop Mappings to BPEL4WS

| Multi-Instance | Mapping to BPEL4WS |
|----------------------------|--|
| MI_Ordering = Parallel | <p>A BPEL4WS <i>while</i> activity will also be used for Parallel ordering. However, since the Task is to be performed in parallel, the mapping to the Tasks cannot be contained within the <i>while</i>. To get the parallel behavior, each copy of the multi-instance Task will be placed into a separate, derived BPEL4WS <i>process</i>^a. A one-way <i>invoke</i> will be used to “spawn” each <i>process</i> and, thus, each instance of the Task. Since the <i>invoke</i> is only one-way, and doesn’t wait for a response from the <i>process</i>, the <i>invoke</i> will complete quickly and the <i>while</i> will cycle through all of its iterations quick enough that the instantiations of the Task mappings will be effectively, if not literally, in parallel.</p> <p>The setting for the MI_FlowCondition attribute will determine what BPEL4WS elements will follow the <i>while</i> activity. These mappings will be described in the next four sections.</p> |
| The <i>while</i> condition | <p>The <i>while</i> condition will be the same as that of the Sequential ordering (see previous section).</p> |
| Spawning the process | <p>In the <i>while</i> activity, a one-way <i>invoke</i> activity will be created and used to “spawn” each of the derived <i>processes</i>. The <i>name</i> attribute for each derived <i>invoke</i> will be in the following format:</p> <pre data-bbox="491 1056 1273 1083"><invoke name="Spawn_Process_For_[activity.Name]" ... ></pre> <p>This <i>invoke</i> will replace the mappings of the original activity, which was in the <i>while</i> for Standard loops and Sequential Multi-Instance Loops.</p> |
| The spawned process | <p>The derived <i>process</i> will start with a <i>receive</i> that accepts the message that is sent by the one-way <i>invoke</i> that is within the <i>while</i> loop of the original <i>process</i>. The name of the process will be "Spawned_Process_For_[activity.Name]." The original Task will be mapped and those BPEL4WS elements will follow the initial <i>receive</i>.</p> <p>After all the mapped elements have been completed, then a one-way <i>invoke</i> will be used to send a message back to the original <i>process</i> has a notification that the spawned <i>process</i> is completed. This will be the last element of the spawned <i>process</i> (see Figure 11.3 and Example 11.3). The <i>name</i> attribute for the derived <i>invoke</i> will be in the following format:</p> <pre data-bbox="491 1472 1158 1499"><invoke name="[activity.Name]_Completed" ... ></pre> |

Table 11.21 - Parallel Multi-Instance Activity Loop Mappings to BPEL4WS

| Multi-Instance | Mapping to BPEL4WS |
|--|---|
| Copying variables to/ from the spawned processes | <p>Since the Parallel Multi-Instance Task mappings are going to be performed within the a different process instance, the variables of the original <i>process</i> will need to be passed to the spawned <i>process</i> through the <i>inputVariable</i> of the one-way <i>invoke</i> that spawns the <i>process</i>. Likewise, any variables that are updated in the spawned <i>process</i> will need to be passed back to the original <i>process</i> through the <i>inputVariable</i> of the one-way <i>invoke</i> that indicates that the spawned <i>process</i> has completed.</p> <p>Note: Once the individual derived processes are instantiated, they will be blind to any changes in process variables. From the BPMN point of view, all the multi-instance activities are within the same context as the original Process and, thus, should be able to utilize any dynamic changes to Process Properties (BPEL4WS variables) as they occur (this is especially true for multi-instance Sub-Processes). It is up to the BPEL4WS execution environment to provide a “virtual context” for all the derived processes to “share” the process variables.</p> |
| Receiving completion messages | <p>As mentioned above, the spawned <i>processes</i> will send a message back to the original <i>process</i> after it has completed performing the behavior of the original activity. A BPEL4WS <i>receive</i> activity will be used to receive the messages back from all the spawned <i>processes</i>. The settings of the MI_FlowCondition will determine The <i>name</i> attribute for each derived <i>receive</i> will be structured as follows:</p> <pre><receive name="[activity.Name]_Completed" ... ></pre> <p>The setting of the MI_FlowCondition attribute will determine how many <i>receive</i> activities will be required. Once the appropriate number of messages have been received back from the spawned <i>processes</i>, the original <i>process</i> will continue.</p> |

- a. Note: BPEL4WS does not have a sub-process capability. It is likely that sub-processes, both Embedded and Reference, will be added to BPEL4WS in the future. When this capability has been added, the mapping for derived processes will be updated.

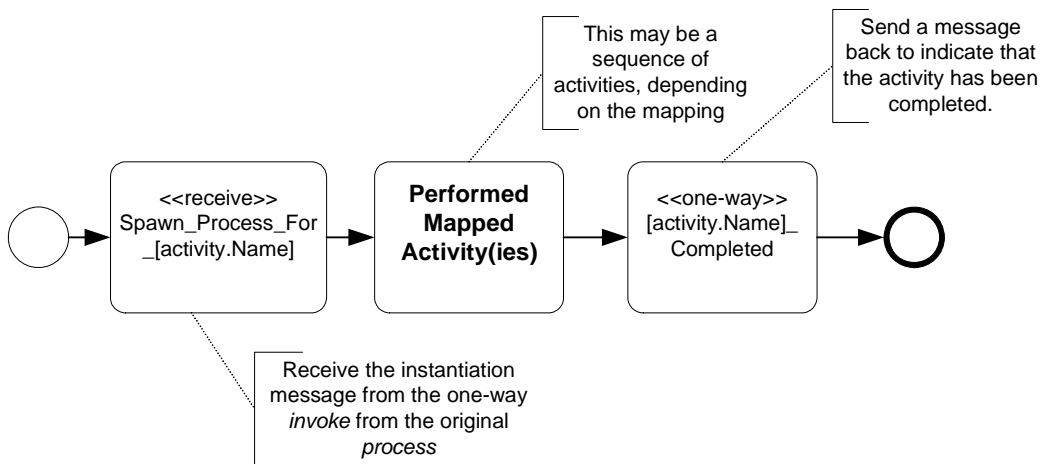

Figure 11.3 - Structure of Process to be Spawned for Parallel Multi-instance

Example 11.5 displays some sample BPEL4WS code that reflects the mapping of a Multi-Instance loop that has Parallel ordering and must synchronize all the looped activities.

```

<process name="Spawned_Process_For_[activity.Name]" ... >
  <sequence>
    <receive name="Spawn_Process_For_[activity.Name]" ... >

    <!--The mappings of the original activity are placed here.-->

    <invoke name="[activity.Name]_Completed" ... >
  </sequence>
</process>

```

Example 11.3 - BPEL4WS Sample of a derived process for Parallel Multi-Instance loops

Parallel Multi-Instance Loops -- Flow Condition All

The loop mappings for Parallel Multi-Instance loops that have an MI_FlowCondition of All are described in the following table (these mappings extend the mappings of the Parallel Multi-Instance Setup--refer to the section above):

Table 11.22 - Parallel Multi-Instance Activity, MI_FlowCondition = All

| Multi-Instance | Mapping to BPEL4WS |
|---|---|
| MI_FlowCondition = All | This setting utilizes the mechanisms described above for the Parallel ordering. The “All” setting requires that all of the spawned <i>processes</i> must be completed before the original <i>process</i> can continue (see Figure 11.4 and Example 11.4). |
| Synchronizing the completion of the spawned processes | The synchronization from the spawned <i>processes</i> is managed through the messages sent by those <i>processes</i> when they have completed the behavior defined by the original activity. These messages will be received by the original <i>process</i> and when the messages from all the spawned <i>processes</i> are received, then the original <i>process</i> can continue. To ensure that all the messages are received, a second <i>while</i> activity will be used. This <i>while</i> will contain a <i>receive</i> activity (for the completion messages) and an <i>assign</i> activity to increment the loop counter. The <i>while condition</i> attribute will be the same as the condition for the <i>while</i> that generated all the spawned <i>processes</i> , so that the same number of messages will be received as there were spawned <i>processes</i> . |
| Resetting the loop Counter | Prior to the second <i>while</i> activity, another <i>assign</i> will be required to reset the loop counter. The contents of the <i>assign</i> activity will be the same as the <i>assign</i> that originally initialized the loopCounter. The <i>name</i> attribute for the derived <i>assign</i> will be in the following format: <assign name="[activity.Name]_reset_loopCounter" ... > |

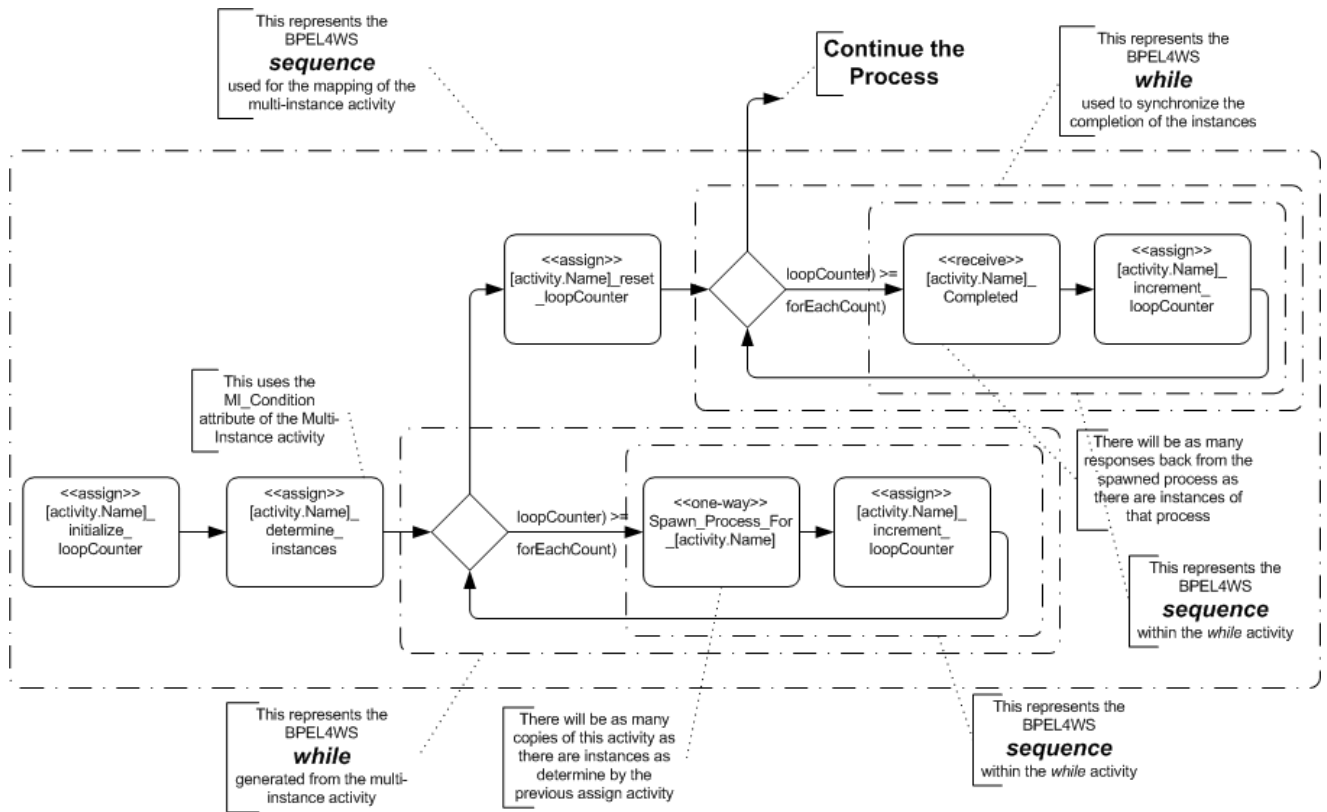

Figure 11.4 - BPEL4WS Pattern of Parallel Multi-instance, MI_FlowCondition = All

```

<!-- The Process data is defined first-->
<variable name="[activity.Name]_loopCounter" messageType="loopCounterMessage" />
<variable name="[activity.Name]_forEachCount" messageType="forEachCounterMessage" />
<!-- The contents of the process prior to the looping activity are here-->
<sequence>
  <assign name="[activity.Name]_initialize_loopCounter">
    <copy>
      <from expression="0"/>
      <to variable="[activity.Name]_loopCounter" part="loopCounter" />
    </copy>
  </assign>
  <assign name="[activity.Name]_determine_instances">
    <copy>
      <from expression="[MI_Condition Expression]"/>
      <to variable="[activity.Name]_forEachCount" part="forEachCount" />
    </copy>
  </assign>
  <while condition=" bpws:getVariableData([activity.Name]_loopCounter,loopCounter) >=
    bpws:getVariableData([activity.Name]_forEachCount,forEachCount)">
    <sequence>
      <invoke name=" Spawn_Process_For_[activity.Name]" ... >
      <assign name="[activity.Name]_increment_counter">
        <copy>
          <from expression="bpws:getVariableData([activity.Name]_loopCounter,loopCounter)+1"/>
          <to variable="[activity.Name]_loopCounter" part="loopCounter" />
        </copy>
      </assign>
    </sequence>
  </while>
  <assign name="[activity.Name]_reset_loopCounter">
    <copy>
      <from expression="0"/>
      <to variable="[activity.Name]_loopCounter" part="loopCounter" />
    </copy>
  </assign>
  <!-- Set a while to receive all the return messages. The condition will be the same.-->
  <while condition=" bpws:getVariableData([activity.Name]_loopCounter,loopCounter) >=
    bpws:getVariableData([activity.Name]_forEachCount,forEachCount)">
    <sequence>
      <receive name="[activity.Name]_Completed" ... >
      <assign name="[activity.Name]_increment_counter">
        <copy>
          <from expression="bpws:getVariableData([activity.Name]_loopCounter,loopCounter)+1"/>
          <to variable="[activity.Name]_loopCounter" part="loopCounter" />
        </copy>
      </assign>
    </sequence>
  </while>
</sequence>
<!-- The contents of the process after the looping activity are here-->

```

Example 11.4 - BPEL4WS Sample of a Parallel Multi-Instance Loop, MI_FlowCondition = All

Parallel Multi-Instance Loops -- Flow Condition One

The loop mappings for Parallel Multi-Instance loops that have a MI_FlowCondition of One are described in the following table (these mappings extend the mappings of the Parallel Multi-Instance Setup--refer to the section above):

Table 11.23 - Parallel Multi-Instance Activity Loop, MI_FlowCondition = One

| Multi-Instance | Mapping to BPEL4WS |
|----------------------------------|--|
| MI_FlowCondition = One | This setting utilizes the mechanisms described above for the Parallel ordering. The “One” setting requires that only one of the spawned <i>processes</i> must be completed before the original <i>process</i> can continue (see Figure 11.5 and Example 11.5). |
| Receiving the completion message | <p>Only one message is required from any one of the spawned <i>processes</i> before the original <i>process</i> can continue. Thus, there will be a single <i>receive</i> activity following the <i>while</i> activity. The <i>receive</i> will be the last element of the <i>sequence</i> that was started for the mapping of the Multi-Instance activity. The other spawned <i>processes</i> will continue there activities in parallel, but their completion will have no direct impact on the flow of the main process (their messages won’t be received).</p> <p>Note: As mentioned above, it is up to the BPEL4WS execution environment to provide a “virtual context” for all the derived processes to “share” the process variables that may be updated by the spawned processes with the original process, even if there are no specific BPEL4WS activities to manage this information.</p> |

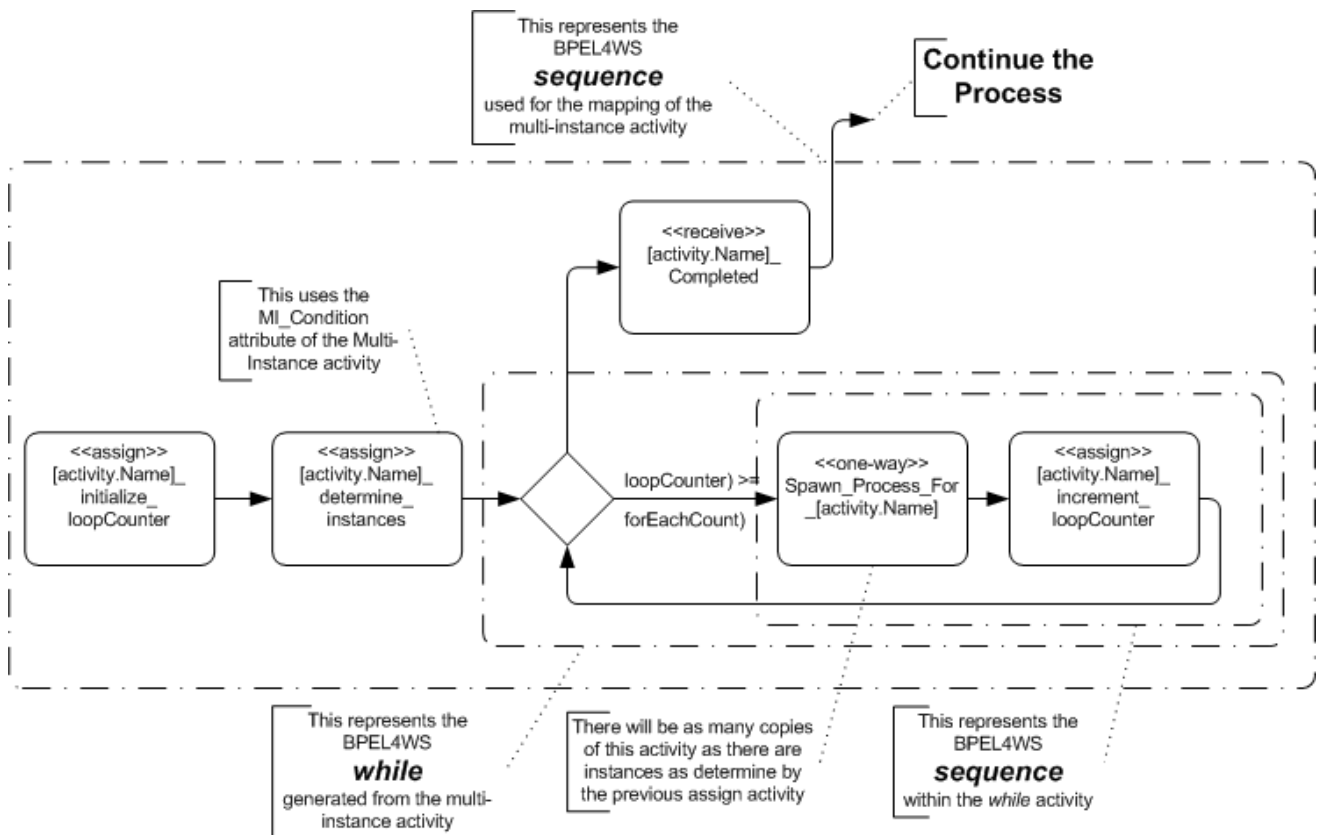

Figure 11.5 - BPEL4WS Pattern of Parallel Multi-instance, MI_FlowCondition = One

Example 11.5 displays some sample BPEL4WS code that reflects the mapping of a Multi-Instance loop that has Parallel ordering and must wait for only one of the looped activities.

```

<!-- The Process data is defined first-->
<variable name="[activity.Name]_loopCounter" messageType="loopCounterMessage" />
<variable name="[activity.Name]_forEachCount" messageType="forEachCounterMessage" />
<!-- The contents of the process prior to the looping activity are here-->
<sequence>
  <assign name="[activity.Name]_initialize_loopCounter">
    <copy>
      <from expression="0"/>
      <to variable="[activity.Name]_loopCounter" part="loopCounter" />
    </copy>
  </assign>
  <assign name="[activity.Name]_determine_instances">
    <copy>
      <from expression="[MI_Condition Expression]"/>
      <to variable="[activity.Name]_forEachCount" part="forEachCount" />
    </copy>
  </assign>
  <while condition="bpws:getVariableData([activity.Name]_loopCounter,loopCounter) >=
    bpws:getVariableData([activity.Name]_forEachCount,forEachCount)">
    <sequence>

      <!--The mappings of the original activity are placed here.-->

      <assign name="[activity.Name]_increment_counter">
        <copy>
          <from expression="bpws:getVariableData([activity.Name]_loopCounter,loopCount)+1"/>
          <to variable="[activity.Name]_loopCounter" part="loopCounter" />
        </copy>
      </assign>
    </sequence>
  </while>
  <receive name="[activity.Name]_Completed" ... >
</sequence>
<!-- The contents of the process after the looping activity are here-->

```

Example 11.5 - BPEL4WS Sample of a Parallel Multi-Instance Loop, MI_FlowCondition = One

Parallel Multi-Instance Loops -- Flow Condition Complex

The loop mappings for Parallel Multi-Instance loops that have a MI_FlowCondition of Complex are described in the following table (these mappings extend the mappings of the Parallel Multi-Instance Setup--refer to the section above):

Table 11.24 - Parallel Multi-Instance Activity Loop, MI_FlowCondition = Complex

| Multi-Instance | Mapping to BPEL4WS |
|----------------------------|--|
| MI_FlowCondition = Complex | The mapping for this setting is almost the same as the MI_FlowCondition of All mapping (as described above) and seen in Figure 11.4 and Example 11.4). The difference is that the number of return messages required before the process flow will continue must be determined and the messages have been received. |

Table 11.24 - Parallel Multi-Instance Activity Loop, MI_FlowCondition = Complex

| Multi-Instance | Mapping to BPEL4WS |
|---|---|
| The while condition for receiving completion messages | The second while in the sequence will be used to receive the appropriate number of completion messages. The ComplexMI_FlowCondition, which MUST be a boolean expression, will determine this number. The <i>while condition</i> be structured as follows: <pre><while condition="[ComplexMI_FlowCondition]"></pre> |

Parallel Multi-Instance Loops -- Flow Condition None

The loop mappings for Parallel Multi-Instance loops that have a MI_FlowCondition of None are described in the following table (these mappings extend the mappings of the Parallel Multi-Instance Setup--refer to the section above):

Table 11.25 - Parallel Multi-Instance Activity Loop, MI_FlowCondition = None

| Multi-Instance | Mapping to BPEL4WS |
|----------------------------------|---|
| MI_FlowCondition = None | This means that there is not synchronization or control of the Tokens that are generated through the multi-instance activity. This means that each Token will continue on independently and each Token will create a separate instantiation of each activity they encounter. Basically, it means there is a separate copy of the whole process, for each copy of the Multi-Instance activity, after that point. Each copy of the remainder of the process will continue independently. To create this behavior, the remainder of the process will moved into a new, derived <i>process</i> . |
| Spawning the rest of the process | This <i>process</i> will be spawned through a one-way <i>invoke</i> that will be placed within the <i>while</i> activity, after the mappings of the original BPMN activity (see Figure 11.6 and Example 11.6). The <i>name</i> attribute for the derived <i>invoke</i> will be in the following format: <pre><invoke name="Spawn_Remainder_of_Process_from_[activity.Name]"...></pre> |

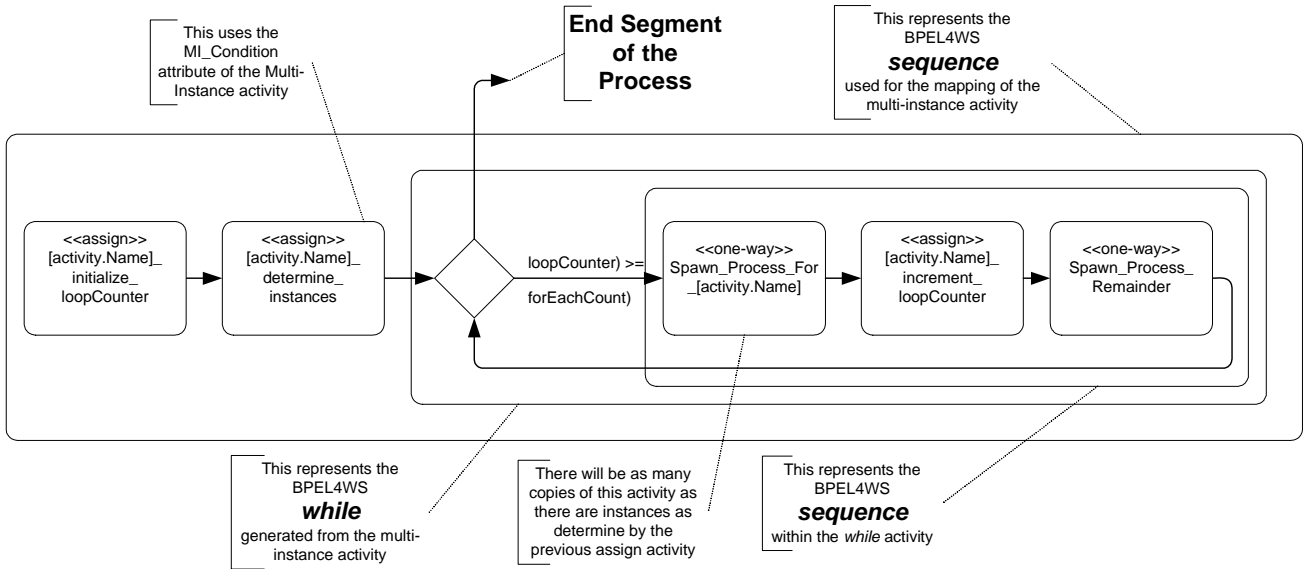

Figure 11.6 - BPEL4WS Pattern of Parallel Multi-instance, MI_FlowCondition = None

Example 11.6 displays some sample BPEL4WS code that reflects the mapping of a Multi-Instance loop that has Parallel ordering and must wait for none of the looped activities.

```

<!-- The Process data is defined first-->
<variable name="[activity.Name]_loopCounter" messageType="loopCounterMessage" />
<variable name="[activity.Name]_forEachCount" messageType="forEachCounterMessage" />
<!-- The contents of the process prior to the looping activity are here-->
<sequence>
  <assign name="[activity.Name]_initialize_loopCounter">
    <copy>
      <from expression="0"/>
      <to variable="[activity.Name]_loopCounter" part="loopCounter" />
    </copy>
  </assign>
  <assign name="[activity.Name]_determine_instances">
    <copy>
      <from expression="[MI_Condition Expression]"/>
      <to variable="[activity.Name]_forEachCount" part="forEachCount" />
    </copy>
  </assign>
  <while condition=" bpws:getVariableData([activity.Name]_loopCounter,loopCounter) >=
    bpws:getVariableData([activity.Name]_forEachCount,forEachCount) ">
    <sequence>

      <!--The mappings of the original activity are placed here.-->

      <assign name="[activity.Name]_increment_counter">
        <copy>
          <from expression="bpws:getVariableData([activity.Name]_loopCounter,loopCounter)+1"/>
          <to variable="[activity.Name]_loopCounter" part="loopCounter" />
        </copy>
      </assign>
    </sequence>
  </while>
  <invoke name="Spawn_Remainder_of_Process_from_[activity.Name]" ... >
</sequence>
<!-- The contents of the process after the looping activity are here-->

```

Example 11.6 - BPEL4WS Sample of a Parallel Multi-Instance Loop, MI_FlowCondition = None

Changes Since 1.0 Draft Version

These are the changes since the last publicly released version:

- The activity looping mappings were completely reorganized and revised.

11.5.2 Sub-Process Mappings

The following table displays a set of mappings from the variations of a Sub-Process to BPEL4WS elements (This extends the mappings that are defined for all activities--refer to the section entitled “Common Activity Mappings” on page 148):

Table 11.26 - Sub-Process Mappings to BPEL4WS

| Sub-Process | Mapping to BPEL4WS |
|---------------------------|---|
| ActivityType = SubProcess | The SubProcessType attribute will determine the exact mapping of a Sub-Process. See the next two sub-sections for these mappings. |

Table 11.26 - Sub-Process Mappings to BPEL4WS

| Sub-Process | Mapping to BPEL4WS |
|----------------|--|
| IsATransaction | The mapping of a Sub-Process set to a Transaction is an Open Issue (See Annex D for other Open Issues). Thus, there is no mapping defined when the IsATransaction is set to True, or the sub-attributes TransactionId, TransactionProtocol, and TransactionMethod. |

Embedded Sub-Process

The following table displays a set of mappings from the variations of an Embedded Sub-Process to BPEL4WS elements (This extends the mappings that are defined for all activities--Section 11.5.2, “Sub-Process Mappings,” on page 166):

Table 11.27 - Embedded Sub-Process Mappings to BPEL4WS

| Sub-Process | Mapping to BPEL4WS |
|---------------------------|--|
| SubProcessType = Embedded | This will map to a BPEL4WS <i>scope</i> element. The scope is not an independent <i>process</i> and will share the <i>process variables</i> of the higher-level <i>process</i> . |
| GraphicalElements | This is a list of all the graphical elements contained within the Process. Each of these elements will have their mapping, as defined in the sections below. |
| Adhoc | Ad Hoc Processes are not executable. Thus, this attribute MUST be set to False if the Process is to be mapped to BPEL4WS. The AdHocCompletionCondition and the AdHocOrdering attributes are only valid if the AdHoc attribute is True. Thus, these attributes will not be mapped to BPEL4WS. |

Independent Sub-Process

The following table displays a set of mappings from the variations of an Independent Sub-Process to BPEL4WS elements (This extends the mappings that are defined for all activities--see Section 11.5.2, “Sub-Process Mappings,” on page 166):

Table 11.28 - Independent Sub-Process Mappings to BPEL4WS

| Task | Mapping to BPEL4WS |
|------------------------------|---|
| SubProcessType = Independent | BPEL4WS does not have a sub-process element. Thus, Independent Sub-Processes MUST map to a BPEL4WS <i>process</i> . That is, the contents of the Sub-Process, whether it is expanded or collapsed, will be contained within a separate <i>process</i> . The DiagramRef and ProcessRef attributes will identify the <i>process</i> that will be used for the mapping to the BPEL4WS <i>process</i> . The attributes of the other BPEL4WS <i>process</i> element will be filled from the mapping of the referenced Process. Section 11.2, “Business Process Mappings,” on page 137 for the details of this mapping. The Sub-Process object itself maps to an <i>invoke</i> activity that “calls” the <i>process</i> . |
| InputPropertyMaps | This attribute is actually a mapping of Process Properties to the Process Properties of the Process being referenced by the Sub-Process Object. The OutputPropertyMaps attribute maps to the <i>inputVariable</i> attribute of the <i>invoke</i> activity. See “Messages” on page 189 for more information about how a BPMN Message maps to BPEL4WS and WSDL. |

Table 11.28 - Independent Sub-Process Mappings to BPEL4WS

| Task | Mapping to BPEL4WS |
|--------------------|--|
| OutputPropertyMaps | This attribute is actually a mapping of Process Properties to the Process Properties of the Process being referenced by the Sub-Process Object. The InputPropertyMaps attribute maps to the <i>outputVariable</i> attribute of the <i>invoke</i> activity. See “Messages” on page 189 for more information about how a BPMN Message maps to BPEL4WS and WSDL. |

Reference Sub-Process

The following table displays a set of mappings from the variations of a Reference Sub-Process to BPEL4WS elements:

Table 11.29 - Reference Sub-Process Mappings to BPEL4WS

| Task | Mapping to BPEL4WS |
|----------------------------|--|
| SubProcessType = Reference | This type of Sub-Process is not directly mapped to BPEL4WS, since BPEL4WS does not support this type of referencing. However, the Sub-Process will be used as a placeholder for the Sub-Process that will be mapped (see next row). |
| TaskRef: Task | This attribute references another Sub-Process in the Process. It is the referenced Sub-Process that will be mapped and the mappings will be placed in the location of the Reference Sub-Process. That is, another copy of the entire mapping of the referenced Sub-Process will be created in this location (the mappings will also exist in the referenced Sub-Process’ original location). |

Changes Since 1.0 Draft Version

These are the changes since the last publicly released version:

- Separate sub-sections were create for the mappings for Embedded, Independent, and Reference Sub-Processes.
- The Embedded Sub-Process mapping was changed from an *invoke* of another *process* to a *scope*.

11.5.3 Task Mappings

The following table displays a set of mappings from the variations of a Task to BPEL4WS elements (This extends the mappings that are defined for all activities--see Section 11.5.1, “Common Activity Mappings,” on page 148):

Table 11.30 - Task Mappings to BPEL4WS

| Task | Mapping to BPEL4WS |
|----------------------|---|
| ActivityType = Task | The TaskType attribute will determine the exact mapping of a Task. See the next eight (8) sub-sections for these mappings. |
| Web service Mappings | The Implementation attribute MUST be a Web service or MUST be converted to a Web Service for mapping to BPEL4WS. The Web Service Attributes are mapped as follows: The Participant attribute is mapped to the <i>partnerLink</i> attribute of the BPEL4WS activity. The Interface attribute is mapped to the <i>portType</i> attribute of the BPEL4WS activity. The Operation attribute is mapped to the <i>operation</i> attribute of the BPEL4WS activity. |

Service Task

The following table displays a set of mappings from the variations of a Service Task to BPEL4WS elements:

Table 11.31 - ServiceTask Mappings to BPEL4WS

| Task | Mapping to BPEL4WS |
|------------------------------|--|
| TaskType = Service | This type of Task maps to an <i>invoke</i> activity. |
| InMessage | The InMessage attribute maps to the <i>inputVariable</i> attribute of the <i>invoke</i> activity. See “Messages” on page 189 for more information about how a BPMN Message maps to BPEL4WS and WSDL. |
| OutMessage | The OutMessage attribute maps to the <i>outputVariable</i> attribute of the <i>invoke</i> activity. See “Messages” on page 189 for more information about how a BPMN Message maps to BPEL4WS and WSDL. |
| Implementation = Web Service | This will map as defined in Table 11.30. |

Receive Task

The following table displays a set of mappings from the variations of a Receive Task to BPEL4WS elements (This extends the mappings that are defined for all Tasks--see Section 11.5.3, “Task Mappings,” on page 168):

Table 11.32 - Receive Task Mappings to BPEL4WS

| Task | Mapping to BPEL4WS |
|------------------------------|---|
| TaskType = Receive | This type of Task maps to a <i>receive</i> activity. |
| Message: Message | The Message attribute maps to the <i>variable</i> attribute of the <i>receive</i> activity. See “Messages” on page 189 for more information about how a BPMN Message maps to BPEL4WS and WSDL. |
| Instantiate False : Boolean | If the Instantiate attribute of the Task is set to False, then the <i>createInstance</i> attribute of the <i>receive</i> will not be included or it will be set to “no.” If the Instantiate attribute of the Task is set to True, then the <i>createInstance</i> attribute of the <i>receive</i> will be set to “yes.” |
| Implementation = Web Service | This will map as defined in Table 11.30. |

Send Task

The following table displays a set of mappings from the variations of a Send Task to BPEL4WS elements:

Table 11.33 - Send Task Mappings to BPEL4WS

| Task | Mapping to BPEL4WS |
|-----------------|--|
| TaskType = Send | This type of Task maps to a <i>reply</i> or an <i>invoke</i> activity. The appropriate BPEL4WS activity will be determined by the implementation defined for the Task. That is, the <i>portType</i> and <i>operation</i> of the Task will be used to check to see if an upstream Receive Task have the same <i>portType</i> and <i>operation</i> . If these two attributes are matched, then the Send Task will map to a <i>reply</i> , if not, the Send Task will map to an <i>invoke</i> . |

Table 11.33 - Send Task Mappings to BPEL4WS

| Task | Mapping to BPEL4WS |
|------------------------------|---|
| Message: Message | The Message attribute maps to the <i>variable</i> attribute of the <i>reply</i> activity or it maps to the <i>inputVariable</i> attribute of the <i>invoke</i> activity. See “Messages” on page 189 for more information about how a BPMN Message maps to BPEL4WS and WSDL. |
| Implementation = Web Service | This will map as defined in Table 11.30. |

User Task

The following table displays a set of mappings from the variations of a User Task to BPEL4WS elements:

Table 11.34 - User Task Mappings to BPEL4WS

| Task | Mapping to BPEL4WS |
|------------------------------|---|
| TaskType = User | This type of Task maps to an <i>invoke</i> activity. |
| Performers: String | The Performers is information needed by the implementation. Thus, it will be included in the InMessage being sent to the Web service, through the <i>inputVariable</i> attribute of the <i>invoke</i> activity. |
| InMessage | The InMessage attribute maps to the <i>inputVariable</i> attribute of the <i>invoke</i> activity. See “Messages” on page 189 for more information about how a BPMN Message maps to BPEL4WS and WSDL. |
| OutMessage | The OutMessage attribute maps to the <i>outputVariable</i> attribute of the <i>invoke</i> activity. See “Messages” on page 189 for more information about how a BPMN Message maps to BPEL4WS and WSDL. |
| Implementation = Web Service | This will map as defined in Table 11.30. |

Script Task

The following table displays a set of mappings from the variations of a Script Task to BPEL4WS elements:

Table 11.35 - Script Task Mappings to BPEL4WS

| Task | Mapping to BPEL4WS |
|-------------------|--|
| TaskType = Script | This type of Task maps to an <i>invoke</i> activity. Since this activity is performed by a process engine, the default settings of the engine must be used to determine the settings of the <i>invoke</i> activity. That is, <i>partnerLink</i> , <i>portType</i> , <i>operation</i> , <i>inputVariable</i> , and maybe <i>outputVariable</i> are derived by these default settings. The script itself is performed when the appropriate Web service of the process engine is invoked. |

Manual Task

The Manual Task does not map to BPEL4WS. Thus, this type of Task should not be used in a Process that is intended to generate BPEL4WS code.

Reference Task

The following table displays a set of mappings from the variations of a Reference Task to BPEL4WS elements:

Table 11.36 - Reference Task Mappings to BPEL4WS

| Task | Mapping to BPEL4WS |
|----------------------|--|
| TaskType = Reference | This type of Task is not directly mapped to BPEL4WS, since BPEL4WS does not support this type of referencing. However, the Task will be used as a placeholder for the Task that will be mapped (see next row). |
| TaskRef: Task | This attribute references another Task in the Process. It is the referenced Task that will be mapped and the mappings will be placed in the location of the Reference Task. That is, another copy of the entire mapping of the referenced Task will be created in this location (the mappings will also exist in the referenced Task's original location). |

None Task

The following table displays a set of mappings from the variations of a None Task to BPEL4WS elements:

Table 11.37 - None Task Mappings to BPEL4WS

| Task | Mapping to BPEL4WS |
|-----------------|---|
| TaskType = None | This type of Task maps to an <i>empty</i> activity. |

Changes Since 1.0 Draft Version

These are the changes since the last publicly released version:

- The mapping was separated into separate sub-sections for each type of Task.
- The reference to a BPEL4WS *until* activity was removed.
- The mapping for the Reference Task was included.

11.6 Gateways

11.6.1 Common Gateway Mappings

The following table displays a set of mappings are common for Gateways to BPEL4WS elements (these mappings extend the mappings common to objects -- see Section 11.3, "Common Flow Object Mappings," on page 139):

Table 11.38 - Common Gateway Mappings to BPEL4WS

| Data-Based Exclusive Gateways | Mapping to BPEL4WS |
|-------------------------------|--|
| Gateway | A Gateway will map to a variety of BPEL4WS elements (e.g., <i>switch</i> , <i>pick</i> , <i>flow</i>) and patterns of elements. |

Table 11.38 - Common Gateway Mappings to BPEL4WS

| Data-Based Exclusive Gateways | Mapping to BPEL4WS |
|-----------------------------------|---|
| Incoming Flow | A Gateway, as with activities, is a location where Sequence Flow can converge. The convergence of Sequence Flow potentially marks the end of a BPEL4WS structured element, if the correct number of flow converge. See Section 11.17, “Determining the Extent of a BPEL4WS Structured Element,” on page 190 for more details on converging of Sequence Flow and their mapping to BPEL4WS. |
| Outgoing Flow | The mapping will begin at the location of the Gateway. The BPMN elements that follow the Gateway, until all the outgoing paths have converged, will be contained within the extent of the mapping (e.g., they will be placed within a <i>sequence</i> within a <i>switch case</i>). The end of the mapping will be determined by the convergence of the paths, through a variety of mechanisms (see Section 11.17, “Determining the Extent of a BPEL4WS Structured Element,” on page 190). |
| Assignments associated with Gates | This will map to a BPEL4WS <i>assign</i> . See Section 11.15, “Assignment Mapping,” on page 189 for more details about the mappings associated with the <i>assign</i> element. |

11.6.2 Exclusive

Data-Based

The following table displays a set of mappings from the variations of a Data-Based Exclusive Gateway to BPEL4WS elements (these mappings extend the mappings common to objects -- see Section 11.6.1, “Common Gateway Mappings,” on page 171):

Table 11.39 - Data-Based Exclusive Gateway Mappings to BPEL4WS

| Data-Based Exclusive Gateways | Mapping to BPEL4WS |
|--|--|
| Gateway (GatewayType = XOR; XORType = Data) | The Gateway will map to a BPEL4WS <i>switch</i> . |
| MarkerVisible | This does not have a mapping to BPEL4WS. Its purpose is to determine whether or not a graphical marker will be displayed. |
| Incoming Flow | |
| Outgoing Flow | |
| Gates | Each Gate will map to a <i>case</i> of the <i>switch</i> . The <i>cases</i> will be listed in the <i>switch</i> in the same order as they are listed for the Gateway. |
| Condition for the Sequence Flow associated with the Gate | This will map to the <i>condition</i> for a <i>switch case</i> . |
| BPMN Elements that follow the Gate. | If there is more than one element that follows the Gate, and this includes Assignments for the Gate, then these elements will be placed inside a <i>sequence</i> activity after these elements have been mapped. |
| DefaultGate | This will map to the <i>otherwise</i> element of the <i>switch</i> . |

Table 11.39 - Data-Based Exclusive Gateway Mappings to BPEL4WS

| Data-Based Exclusive Gateways | Mapping to BPEL4WS |
|--|---|
| BPMN Elements that follow the DefaultGate. | If there is more than one element that follows the DefaultGate, and this includes Assignments for the Gate, then these elements will be placed inside a <i>sequence</i> activity after these elements have been mapped. |

Event-Based

The following table displays a set of mappings from the variations of a Event-Based Exclusive Gateway to BPEL4WS elements (these mappings extend the mappings common to objects -- see Section 11.6.1, “Common Gateway Mappings,” on page 171):

Table 11.40 - Data-Based Exclusive Gateway Mappings to BPEL4WS

| Event-Based Exclusive Gateways | Mapping to BPEL4WS |
|--|---|
| Gateway (GatewayType = XOR; XORType = Event) | This Gateway will map to a BPEL4WS <i>pick</i> . The elements of the <i>pick</i> will be determined by the targets of the outgoing Sequence Flow. The specific mappings are described in the rows below. |
| Instantiate | If the Instantiate attribute of the Gateway is set to False, then the <i>createInstance</i> attribute of the <i>pick</i> MUST NOT be included OR it MUST be set to “no.” If the Instantiate attribute of the Gateway is set to True, then the <i>createInstance</i> attribute of the <i>pick</i> MUST be set to “yes.” |
| Gate with Receive Task as Target | The Receive Task will map to an <i>onMessage</i> element within the <i>pick</i> . The attributes of the Receive Task will map to the appropriate elements of the <i>onMessage</i> , such as <i>operation</i> and <i>portType</i> . See “Receive Task” on page 169 for the mapping of the Receive Task. Note that the name of the Task does not have a corresponding attribute within the <i>onMessage</i> element. |
| Gate with Message Intermediate Event as Target | A Message Intermediate Event will map to an <i>onMessage</i> element within the <i>pick</i> . The attributes of the Message Intermediate Event will map to the appropriate elements of the <i>onMessage</i> , such as <i>operation</i> and <i>portType</i> . See Section 11.4.3, “Intermediate Event Mappings,” on page 142 for the mapping of the Message Intermediate Event. |
| Gate with Timer Intermediate Event as Target | A Timer Intermediate Event, which is the Target of a Sequence Flow associated with the Gate, will map to an <i>onAlarm</i> element within the <i>pick</i> . The <i>TimeDate</i> attribute of the Event will map to the <i>until</i> element of the <i>onAlarm</i> element. The <i>TimeCycle</i> attribute of the Event will map to the <i>for</i> element of the <i>onAlarm</i> element. |
| Gate with Link Intermediate Event as Target | A Rule Intermediate Event, in this situation, will be considered as the same as receiving a message from a process. Thus, this will map to an <i>onMessage</i> element within the <i>pick</i> . The attributes of the Message Intermediate Event will map to the appropriate elements of the <i>onMessage</i> , such as <i>operation</i> and <i>portType</i> . See Section 11.4.3, “Intermediate Event Mappings,” on page 142 for the mapping of the Message Intermediate Event. |

Table 11.40 - Data-Based Exclusive Gateway Mappings to BPEL4WS

| Event-Based Exclusive Gateways | Mapping to BPEL4WS |
|---|--|
| Gate with Rule Intermediate Event as Target | A Rule Intermediate Event, in this situation, will be considered as the same as receiving a message from a system that tracks and generates Rule events. Thus, this will map to an <i>onMessage</i> element within the <i>pick</i> . The attributes of the Message Intermediate Event will map to the appropriate elements of the <i>onMessage</i> , such as <i>operation</i> and <i>portType</i> . See Section 11.4.3, “Intermediate Event Mappings,” on page 142 for the mapping of the Message Intermediate Event. |
| BPMN Elements that follow the first target of a Gate. | If there is more than one element that follows the first target of a Gate, and this includes Assignments for the Gate, then these elements will be placed inside a <i>sequence</i> activity after these elements have been mapped. |

Changes Since 1.0 Draft Version

These are the changes since the last publicly released version:

- A mapping for the Instantiate attribute of the Gateway was added.
- A mapping for the Error Intermediate Event, as a Target, was removed.
- Those mappings that were incomplete in the previous version, were completed.

11.6.3 Inclusive

The following table displays a set of mappings from the variations of a Inclusive Gateway to BPEL4WS elements (these mappings extend the mappings common to objects -- See Section 11.6.1, “Common Gateway Mappings,” on page 171):

Table 11.41 - Inclusive Gateway Mappings to BPEL4WS

| Inclusive Gateways | Mapping to BPEL4WS |
|--|--|
| Gateway (GatewayType = OR) | The Gateway will map to a set of BPEL4WS <i>switches</i> within a BPEL4WS <i>flow</i> . An additional <i>switch</i> will be required if the DefaultGate is used (see below) |
| Gates | Each Gate will map to a <i>switch</i> . Each <i>switch</i> will binary in nature. That is, each switch will have exactly one <i>case</i> and one <i>otherwise</i> . |
| Condition for the Sequence Flow associated with the Gate | This will map to the <i>condition</i> for the <i>switch</i> case. |
| BPMN Elements that follow the Gate. | If there is more than one element that follows the Gate, and this includes Assignments for the Gate, then these elements will be placed inside a <i>sequence</i> activity after these elements have been mapped. If a DefaultGate is used, then an <i>assign</i> activity will follow all the other mappings (see below for details). |
| The <i>otherwise</i> element for the <i>switch</i> | The <i>otherwise</i> element for each <i>switch</i> will contain an <i>empty</i> activity. However, if the DefaultGate is used, then |

Table 11.41 - Inclusive Gateway Mappings to BPEL4WS

| Inclusive Gateways | Mapping to BPEL4WS |
|---|--|
| DefaultGate | <p>The DefaultGate will map to a <i>switch</i>. However, by using the DefaultGate, the mapping to BPEL4WS is more complicated (see Figure 11.7 and Example 11.7). This is the path that is taken if none of the other paths are taken. Thus, the decision about whether the Default Gate should be taken will occur after all the other Gate decisions have been determined. This means that the <i>switch</i> for the DefaultGate will follow the <i>flow</i> activity generated for all the Gates of the Gateway. Also, a <i>sequence</i> activity must encompass the <i>flow</i> and the <i>switch</i>.</p> |
| Create the tracking variable | <p>A <i>variable</i> must be used so that the switch for the DefaultGate will know whether or not the Default BPMN path should be taken. To do this, a BPEL4WS <i>variable</i> must be created with a derived name and will have a structure as follows:</p> <pre data-bbox="496 751 1203 806"><variable name="[Gateway.Name]_noDefaultRequired" messageType="noDefaultRequired" /></pre> |
| Supporting WSDL Message | <p>A WSDL <i>message</i> element will have to be created to support this <i>variable</i>. This <i>message</i> can be used for multiple <i>variables</i>. The <i>message</i> will be structured as follows:</p> <pre data-bbox="496 894 1155 970"><message name="noDefaultRequired" > <part name="noDefault" type="xsd:boolean" /> </message></pre> |
| Initialization of the tracking variable | <p>An <i>assign</i> activity will be created to initialize the <i>variable</i> before the start of the loop. This <i>assign</i> precede the <i>flow</i> activity that contains all the <i>switches</i> derived from the Gates. This will be the first activity within the <i>sequence</i> activity. The <i>assign</i> will be structured as follows:</p> <pre data-bbox="496 1125 1235 1310"><assign name="[Gateway.Name]_initialize_noDefault"> <copy> <from expression="false"/> <to variable="[Gateway.Name]_noDefaultRequired" part="noDefault" /> </copy> </assign></pre> |
| The <i>switch</i> cases | <p>The condition for the <i>switch case</i> will used the noDefaultRequired <i>variable</i> and will structured as follows:</p> <pre data-bbox="496 1398 1378 1759"><switch> <case condition="bpws:getVariableProperty([Gateway.Name]_noDefaultRequired,noDefault)=true"> <sequence> <!--The mappings of the original activity are placed here.--> <!--An assign activity (see below) is placed here.--> </sequence> </case> <otherwise> <empty/> </otherwise> </switch></pre> |

Table 11.41 - Inclusive Gateway Mappings to BPEL4WS

| Inclusive Gateways | Mapping to BPEL4WS |
|---|--|
| BPMN Elements that follow the DefaultGate | If there is more than one element that follows the DefaultGate, and this includes Assignments for the Gate, then these elements will be placed inside a <i>sequence</i> activity after these elements have been mapped. An <i>assign</i> activity will be placed in the sequence after all the other mappings (see next row). |
| Setting of the tracking variable | If any of the <i>switches</i> within the flow passes the condition of the switch case, then the noDefaultRequired must be set to True. This will ensure that the DefaultGate switch will bypass the mapped activities for the BPMN Default Gate. An <i>assign</i> activity will be created to set the <i>variable</i> to True. This will be the last activity within the <i>sequence</i> activity within the <i>switch</i> . The <i>assign</i> will be structured as follows: <pre><assign name="[Gateway.Name]_set_noDefault"> <copy> <from expression="true"/> <to variable="[Gateway.Name]_noDefaultRequired" part="noDefault" /> </copy> </assign></pre> |

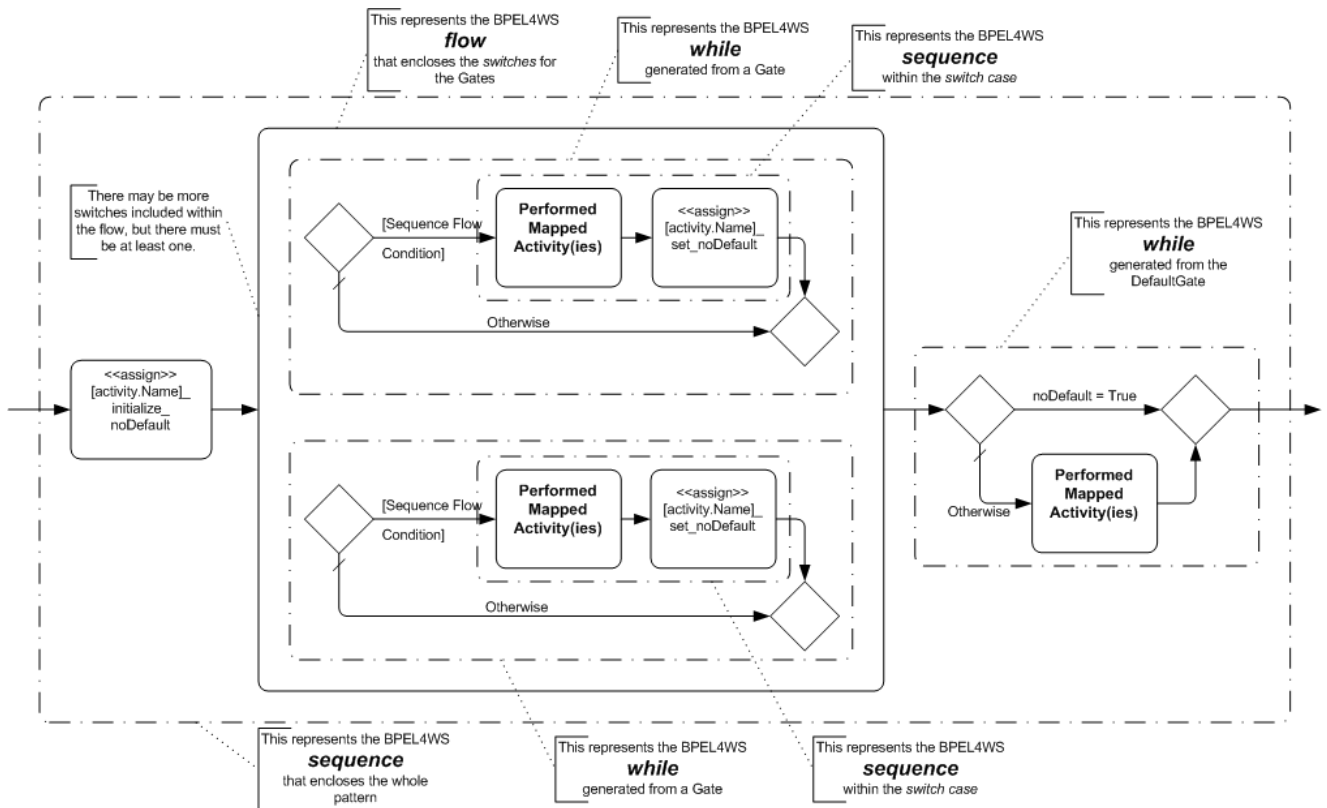

Figure 11.7 - BPEL4WS Pattern of Inclusive Decision with two (2) Gates and a DefaultGate

Example 11.7 displays some sample BPEL4WS code that reflects the mapping of a Multi-Instance loop that has Parallel ordering and must synchronize all the looped activities.

```

<!-- The Process data is defined first-->
<variable name="[activity.Name]_loopCounter" messageType="loopCounterMessage" />
<!-- The contents of the process prior to the looping activity are here-->
<sequence>
  <assign name="[Gateway.Name]_initialize_noDefault">
    <copy>
      <from expression="false"/>
      <to variable="[Gateway.Name]_noDefaultRequired" part="noDefault" />
    </copy>
  </assign>
  <flow>
    <!--There will be as many copies of the switch below as there are Gates.-->
    <switch>
      <case condition="[Sequence Flow Condition]">
        <sequence>

          <!--The mappings of the activities are placed here.-->

          <assign name="[Gateway.Name]_initialize_noDefault">
            <copy>
              <from expression="true"/>
              <to variable="[Gateway.Name]_noDefaultRequired" part="noDefault" />
            </copy>
          </assign>
        </sequence>
      </case>
      <otherwise>
        <empty/>
      </otherwise>
    </switch>
  </flow>
  <switch>
    <case condition=
      "bpws:getVariableProperty([Gateway.Name]_noDefaultRequired,noDefault)=true">
      <sequence>

        <!--The mappings of the activities are placed here.-->

      </sequence>
    </case>
    <otherwise>
      <empty/>
    </otherwise>
  </switch>
</sequence>

```

Example 11.7 - BPEL4WS Sample for the Pattern for an Inclusive Decision with a DefaultGate

Changes Since 1.0 Draft Version

These are the changes since the last publicly released version:

- This mapping, which was not defined in the last version, was defined.

11.6.4 Complex

The behavior and usage of Complex Gateways have not been well enough established for a mapping to BPEL4WS to be defined.

11.6.5 Parallel

The following table displays a set of mappings from the variations of a Parallel Gateway to BPEL4WS elements (these mappings extend the mappings common to objects --see Section 11.6.1, “Common Gateway Mappings,” on page 171):

Table 11.42 - Parallel Gateway Mappings to BPEL4WS

| Parallel Gateways | Mapping to BPEL4WS |
|-----------------------------|---|
| Gateway (GatewayType = AND) | The Gateway will map to a BPEL4WS <i>flow</i> . |

Changes Since 1.0 Draft Version

These are the changes since the last publicly released version:

- This mapping, which was not defined in the last version, was defined.

11.7 Pool

Pools do not have any specific Mapping to Execution Languages. However, a Pool is associated with a mapping to a specific lower level language. For example, one Pool may encompass a BPEL4WS document while another Pool might encompass B2B Collaboration process.

11.8 Lane

Lanes do not have any specific Mapping to Execution Languages. They are designed to help organize and communicate how activities are grouped in a business process.

11.9 Artifacts

As a general rule, Artifacts do not map to BPEL4WS elements. They provide detailed information about how data will interact with the Flow Objects and Flow of Processes.

However, Text Annotations can map to the *documentation* element of BPM execution languages. If the Annotation is associated with a Flow Object and that object has a straight-forward mapping to a BPM execution language element, then the text of the Annotation will be placed in the *documentation* element of that object. If there is no straight-forward mapping to a BPM execution language element, then the text of the Annotation will be appended to the *documentation* element of the *process*.

For any new Artifact that is added to a BPD through a modeling tool, it will have to be determined whether or not that Artifact maps to any BPEL4WS element.

11.10 Sequence Flow

A Sequence Flow may not have a specific mapping to a BPEL4WS in most situations. However, when there is a section of the Diagram that contains parallel activities, then Sequence Flow may map to the *link* element. Details of this mapping are TBD. In general, the set of Sequence Flow within a Pool will determine how BPEL4WS elements are derived and the boundaries of those elements.

The following table displays a set of mappings from Sequence Flow to BPEL4WS elements:

Table 11.43 - Exception Flow Mappings to BPEL4WS

| Sequence Flow | Mapping to BPEL4WS |
|--|---|
| Sequence Flow | This MAY map to a BPEL4WS <i>link</i> element. The location of the Sequence Flow within the Process will determine how or if it is mapped to a <i>link</i> . Even if the Sequence Flow is not mapped to a link, attributes, such as Condition, will be mapped to BPEL4WS elements, as described below. |
| Id, Categories, and Documentation | These Elements do not map to any BPEL4WS elements or attributes. |
| Name | If the Sequence is not being mapped to a <i>link</i> : This attribute does not map to any BPEL4WS elements or attributes. If the Sequence is being mapped to a <i>link</i> : The Name attribute of the Process SHALL map to <i>name</i> attribute of the <i>link</i> . The extra spaces and non-alphanumeric characters MUST be stripped from the Name to fit with the XML specification of the <i>name</i> attribute. Note that there may be two or more elements with the same name after the BPMN name has been stripped. |
| Source | If the Sequence is not being mapped to a <i>link</i> : This attribute does not map to any BPEL4WS elements or attributes. If the Sequence is being mapped to a <i>link</i> : This mapping is described in the next four (4) Rows. |
| Source Object is an Activity (for a <i>link</i>) | The mapping of the source activity will now include a <i>source</i> element. The Name of the Sequence Flow will map to <i>linkName</i> attribute of the <i>source</i> element. The extra spaces and non-alphanumeric characters MUST be stripped from the Name to fit with the XML specification of the <i>name</i> attribute. Note that there may be two or more elements with the same name after the BPMN name has been stripped. For an exception to the location of the <i>source</i> element, see the description of the mapping for a ConditionExpression when the Source object is an Activity below. |
| Source Object is a Gateway (for a <i>link</i>) | This mapping is described in the next two (2) Rows. |
| The Gateway maps to an activity (e.g., <i>switch</i>) | This mapping is the same as if the source object is an activity (see above). |
| The Gateway does not map to an activity | This Sequence Flow will be essentially combined with one of the Gateway's incoming Sequence Flow. (There will be a separate <i>link</i> for each of the incoming Sequence Flow). The Source of the second Sequence will be used at the Source for the original Sequence Flow. Then, this mapping is the same as if the Source object is an activity (see above). |

Table 11.43 - Exception Flow Mappings to BPEL4WS

| Sequence Flow | Mapping to BPEL4WS |
|--|--|
| Target | <p>If the Sequence is not being mapped to a <i>link</i>: This attribute does not map to any BPEL4WS elements or attributes. If the Sequence is being mapped to a <i>link</i>: This mapping is described in the next four (4) Rows.</p> |
| Target Object is an Activity | <p>The mapping of the target activity will now include a <i>target</i> element. The Name of the Sequence Flow will map to <i>linkName</i> attribute of the <i>target</i> element. The extra spaces and non-alphanumeric characters MUST be stripped from the Name to fit with the XML specification of the <i>name</i> attribute. Note that there may be two or more elements with the same name after the BPMN name has been stripped.</p> |
| Target Object is a Gateway | <p>This mapping is described in the next two (2) Rows.</p> |
| The Gateway maps to an activity (e.g., <i>switch</i>) | <p>This mapping is the same as if the target object is an activity (see above).</p> |
| The Gateway does not map to an activity | <p>This Sequence Flow will be essentially combined with one of the Gateway’s outgoing Sequence Flow. (There will be a separate <i>link</i> for each of the outgoing Sequence Flow). The Target of the second Sequence will be used at the Target for the original Sequence Flow. Then, this mapping is the same as if the target object is an activity (see above).</p> |
| ConditionType = None | <p>If the Sequence is not being mapped to a <i>link</i>: This attribute does not map to any BPEL4WS elements or attributes. If the Sequence is being mapped to a <i>link</i>: This means that there is no condition placed on the transition between elements (through the link). Thus, there is nothing to be mapped to BPEL4WS.</p> |
| ConditionType = Expression | <p>This mapping is described in the next two (2) Rows.</p> |
| Source Object is a Gateway | <p>The mapping of the Sequence Flow in this situation is described in Section 11.6.2, “Exclusive,” on page 172, Section 11.6.3, “Inclusive,” on page 174, and Section 11.6.4, “Complex,” on page 178.</p> |
| Source Object is an Activity | <p>Since a Sequence Flow MUST NOT have a Condition if the Source is an activity, unless there are multiple outgoing Sequence Flow, a BPEL4WS <i>flow</i> will be required and the Sequence Flow will map to a <i>link</i> element. An <i>empty</i> activity will be placed in the flow and will contain all the <i>source</i> elements. The ConditionExpression will then map to the <i>transitionCondition</i> attribute of the <i>source</i> element that is contained in the appropriate BPEL4WS activity (see a description of locating the source above).</p> |
| ConditionType = Default | <p>The mapping of the Sequence Flow in this situation is described in Section 11.6.2, “Exclusive,” on page 172, Section 11.6.3, “Inclusive,” on page 174, and Section 11.6.4, “Complex,” on page 178.</p> |
| Quantity 1 : Integer | <p>The mapping of the Quantity attribute, if its value is greater than one (1), BPEL4WS is an open issue. See Annex D for other Open Issues.</p> |

Changes Since 1.0 Draft Version

These are the changes since the last publicly released version:

- The details of the mapping, which had not been defined in the last version, were included.

11.10.1 When to Map a Sequence Flow to a BPEL4WS Link

In many situations, a Sequence Flow will not map to a BPEL4WS *link* element.

- ◆ To connect activities that are listed in a BPEL4WS structured activity (e.g., a *sequence*), the *link* elements are not required.

The ordering of the list in the sequence provides the direction of flow (see Example 11.8).

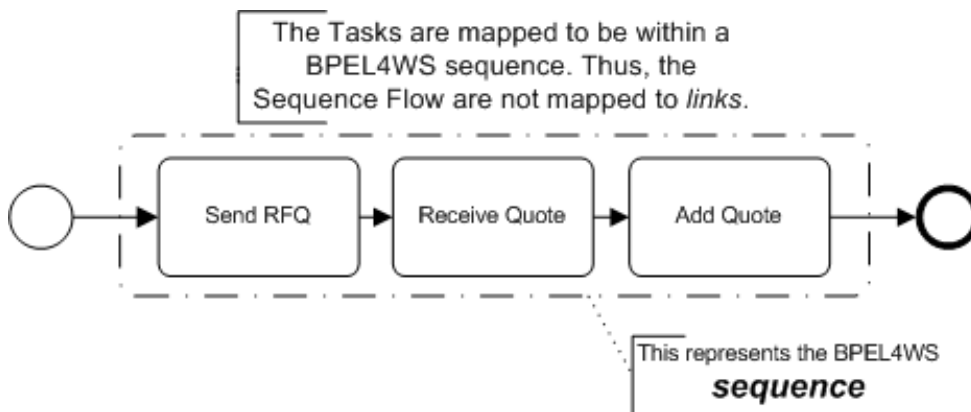

Figure 11.8 - Example: Sequence Flow that are not used for BPEL4WS links

- ◆ *Link* elements are only appropriate when the Sequence Flow are Connecting Objects that are within a BPEL4WS *flow*.

However, it is only the Sequence Flow that are completely contained within the boundaries of the *flow* will be mapped to a *link* (see Example 11.8). It should be noted that if another structured activity (e.g., a *switch*) is contained within the flow, then the Sequence Flow that would be appropriate for the contents of the structured activity, would not be mapped to a *link*.

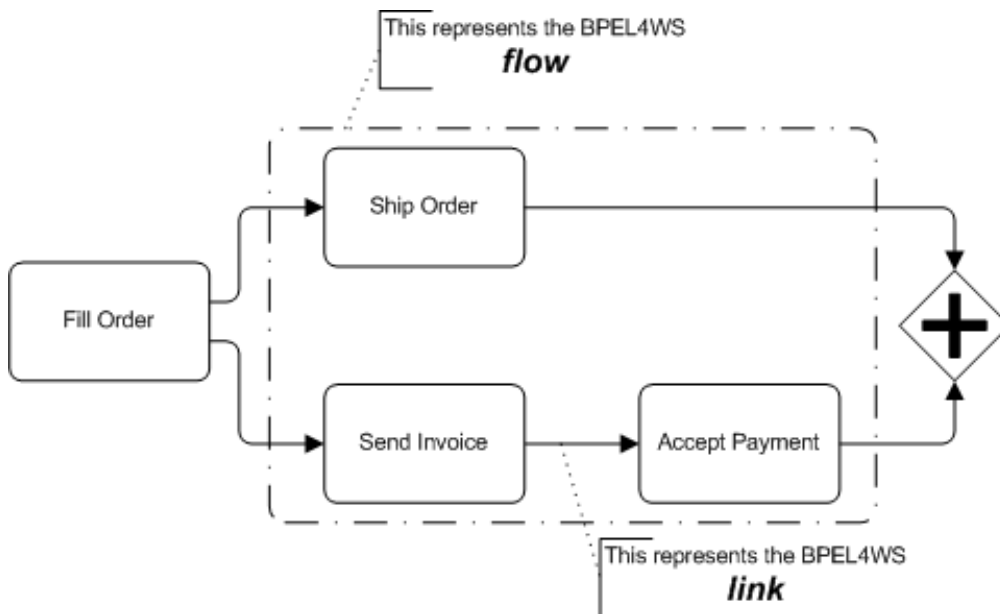

Figure 11.9 - Example: A Sequence Flow that is used for a BPEL4WS link

Changes Since 1.0 Draft Version

These are the changes since the last publicly released version:

- This section was added.

11.11 Message Flow

A Message Flow does not have a specific mapping to a BPEL4WS element. It represents a message that is sent through a WSDL *operation* that is referenced in a BPEL4WS *receive*, *reply*, or *invoke*.

11.12 Association

An Association does not have a specific mapping to an execution language element. These objects and the Artifacts they connect to provide additional information for the reader of the BPMN Diagram, but do not directly affect the execution of the Process.

11.13 Exception Flow

BPMN Exception Flow is all the activities, connected by Sequence Flow, which flow from an Intermediate Event attached to the boundary of an activity, until the flow merges back into the Normal Flow (sometimes at the point of an End Event).

BPEL4WS handles exceptions in a much more structured and programmatic manner. If triggered through a *fault*, the activities in an *faultHandlers* will be performed and completed, and then the *process* will continue from the point where the interrupted activity would have completed normally. Thus, the *faultHandlers* element is a completely contained structured element.

Since BPMN handles Exception Flow with much more flexibility, so that the modeler can have the Exception Flow go wherever it is appropriate, there are different challenges to the BPEL4WS mapping, depending on the configuration of the BPMN model.

The following table displays the mapping Exception Flow to BPEL4WS:

Table 11.44 - Common Exception Flow Mappings to BPEL4WS

| Exception Flow | Mapping to BPEL4WS |
|--------------------------------------|--|
| Activities within the Exception Flow | All the activities that follow the attached Intermediate Event, until the Exception Flow merges back into the Normal Flow, will be mapped to BPEL4WS and then placed within the <i>faultHandlers</i> element for the <i>scope</i> of the activity (and usually within a <i>sequence</i>). |

Additional BPEL4WS mapping patterns for Exception Flow will be described in the next three (3) sections.

The Exception Flow Merges back into the Normal Flow After the Activity

In this situation, the Exception Flow may contain one or more activities, but will merge back into the Normal Flow at the same object that follows the activity that is the source of the Exception Flow (see Figure 11.10). This situation maps closely to the BPEL4WS mechanism for exception handling. Thus, no special mapping mechanisms are required.

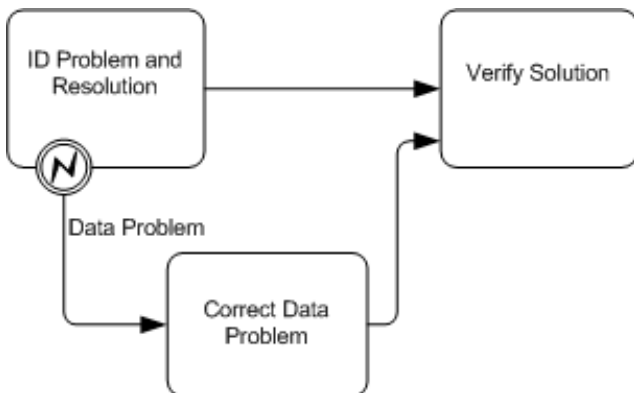

Figure 11.10 - Exception Flow Merging back into Normal Flow Immediately after Interrupted Activity

The Exception Flow Merges back into the Normal Flow Further Downstream

In this situation, the activities in the Exception Flow substitute for some of the Normal Flow activities and, thus, the Exception Flow will skip these activities and merge into the Normal Flow further downstream (see Figure 11.11). Alternatively, the exception may create a situation where the Process must end prematurely, which means that the Exception Flow will merge with the Normal Flow at an End Event (see Figure 11.12). In either situation, special BPEL4WS patterns will have to appended to the basic Exception Flow mappings.

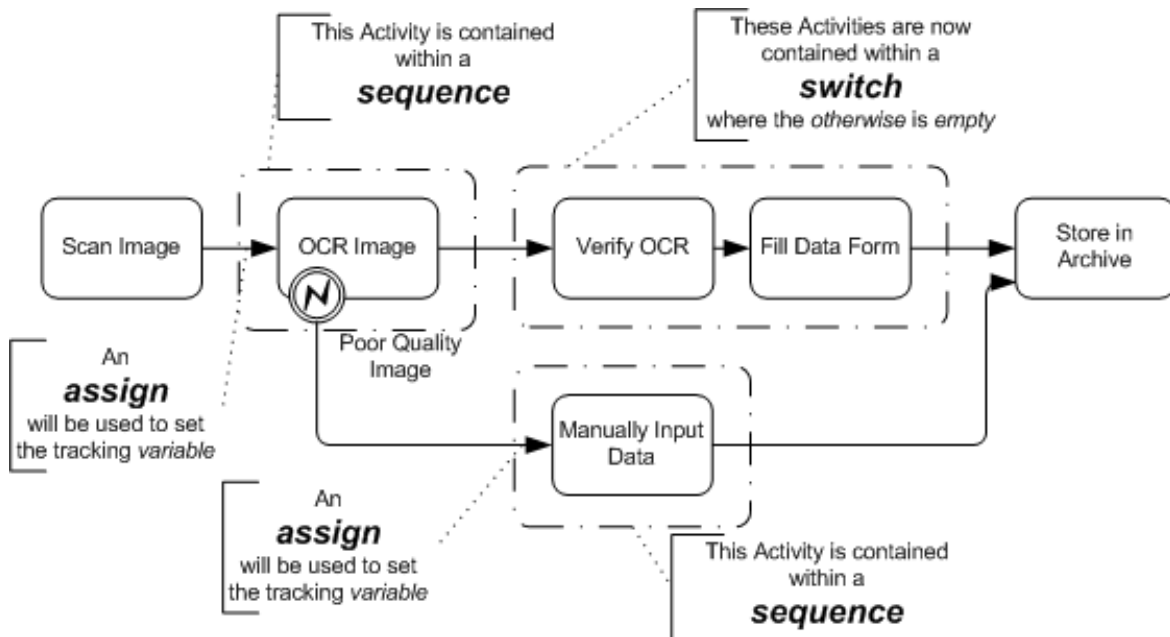

Figure 11.11 - Exception Flow Merging back into the Normal Flow Further Downstream

The following table displays the mapping Exception Flow to BPEL4WS (these mappings extend the mappings common to Exception Flow -- see above):

Table 11.45 - Exception Flow Merging back into the Normal Flow Further Downstream

| Exception Flow | Mapping to BPEL4WS |
|--------------------------------------|--|
| Activities within the Exception Flow | If there is only one activity in the <i>faultHandlers</i> element for the <i>scope</i> of the activity, then this activity will be placed within a <i>sequence</i> and preceded by an <i>assign</i> (as described below). |
| Original Activity | The mapping of the original activity will be placed within a <i>sequence</i> (if it had not been already). |
| After the Original Activity | The original activity will now be followed by a <i>switch</i> , instead of what would have been normally mapped there. |
| Switch Characteristics | The <i>switch</i> will be binary in nature. There will be one <i>case</i> and an <i>otherwise</i> element. |
| Create the tracking variable | A <i>variable</i> must be used so that the switch will know whether or not the Exception Flow or Normal Flow had reached that point in the Process. To do this, a BPEL4WS <i>variable</i> must be created with a derived name and will have a structure as follows: <pre><variable name="[activity.Name]_normalCompletion" messageType="noDefaultRequired" /></pre> |
| Supporting WSDL Message | A WSDL <i>message</i> element will have to be created to support this <i>variable</i> . This <i>message</i> can be used for multiple <i>variables</i> . The <i>message</i> will be structured as follows: <pre><message name="noDefaultRequired" > <part name="normalCompletion" type="xsd:boolean" /> </message></pre> |

Table 11.45 - Exception Flow Merging back into the Normal Flow Further Downstream

| Exception Flow | Mapping to BPEL4WS |
|---|---|
| Initialization of the Tracking Variable | <p>An <i>assign</i> activity will be created to initialize the <i>variable</i> before the start of the original activity. It will be the first activity in the <i>sequence</i> described above. The <i>assign</i> will be structured as follows:</p> <pre data-bbox="496 506 1350 688"> <assign name="[activity.Name]_initialize_normalCompletion"> <copy> <from expression="true"/> <to variable="[activity.Name]_normalCompletion" part="normalCompletion" /> </copy> </assign> </pre> |
| Setting of the tracking variable | <p>If a fault is thrown and <i>faultHandlers</i> is activated, then an <i>assign</i> activity will be used to set the <i>variable</i> to False. This will be the first activity within the <i>sequence</i> activity of the <i>faultHandlers</i>. The <i>assign</i> will be structured as follows:</p> <pre data-bbox="496 810 1249 993"> <assign name="[activity.Name]_set_normalCompletion"> <copy> <from expression="false"/> <to variable="[activity.Name]_normalCompletion" part="normalCompletion" /> </copy> </assign> </pre> |
| <i>Switch cases</i> | <p>The case for the switch will contain all the mappings for all activities that occur in the Process until the Exception Flow has merged back (which could be the end of the Process), usually within a <i>sequence</i>. The otherwise for the switch will contain an <i>empty</i> activity.</p> <p>The condition for the <i>switch case</i> will use the <i>normalCompletion variable</i> and will be structured as follows:</p> <pre data-bbox="496 1220 1366 1608"> <switch> <case condition="bpws:getVariableProperty([activity.Name]_normalCompletion, normalCompletion)=true"> <sequence> <!--The mappings of the Process activities until the merging of the Exception Flow are placed here.--> </sequence> </case> <otherwise> <empty/> </otherwise> </switch> </pre> |
| Potential Invalid Model | <p>If the Exception Flow occurs in the larger context of a set of parallel activities, then the Exception Flow must merge back into the Normal Flow prior to the end of the parallel activities (a BPEL4WS <i>flow</i>), or this will create an invalid model.</p> |

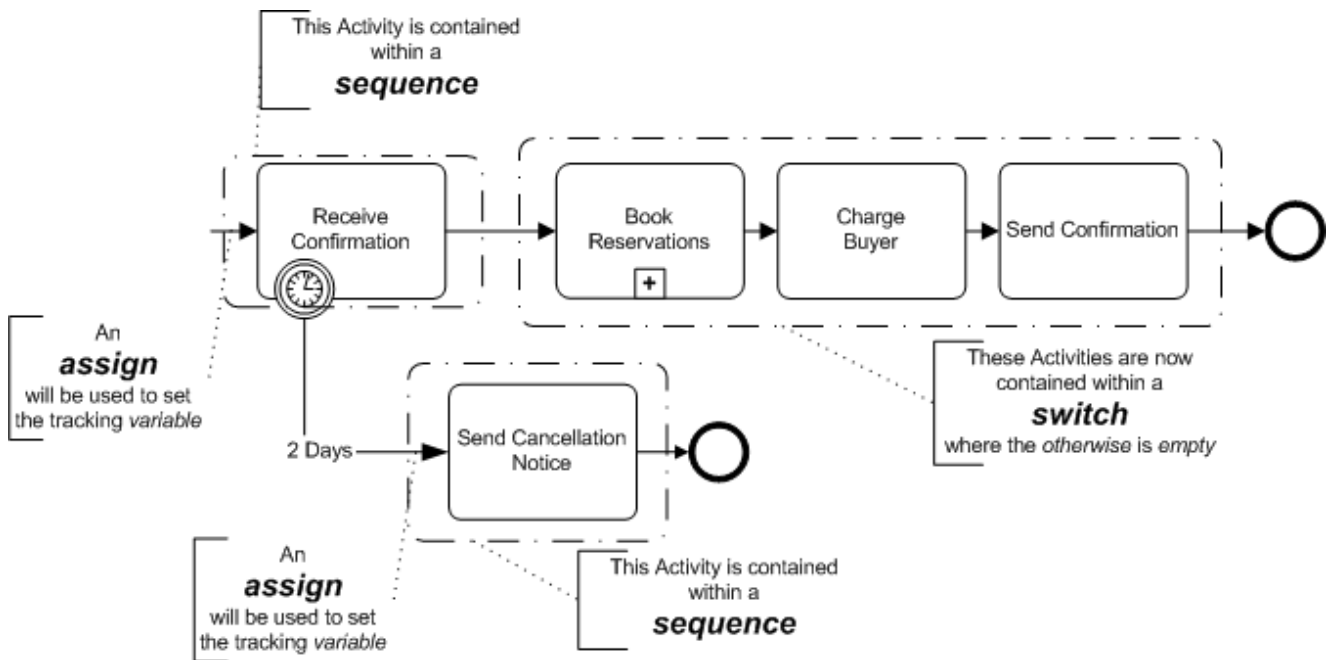

Figure 11.12 - Exception Flow Merging back into the Normal Flow at the End Event

The Exception Flow Loops back into the Normal Flow Upstream

In this situation, the Exception Flow will loop back into the Normal Flow prior to the completion of the activity that is the source of the Exception Flow (see Figure 11.13). This is a particularly challenging mapping and cannot be done entirely within the confines of the original BPEL4WS *process*. Another process will need to be derived and then “spawned” until the original activity can be completed normally.

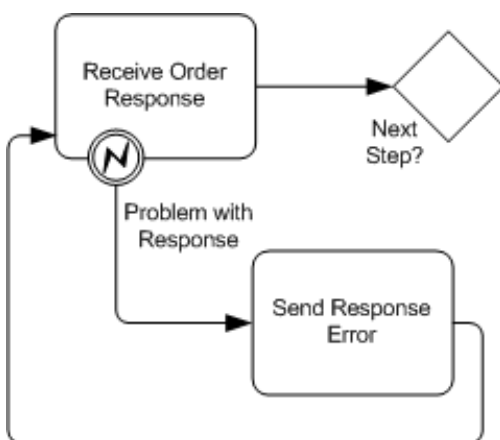

Figure 11.13 - Example of Exception Flow Looping Back into the Normal Flow Upstream

This part of the Process will be modified at the BPEL4WS level so that the loop can be performed (through calling another *process*). If the flow moves to the *faultHandlers* activity, this means that the original activity will need to be performed again. Thus, the original activity will be duplicated in another *process* and the *faultHandlers* will contain a one-way *invoke* to “spawn” this other process (see Figure 11.14). In addition, the original process will wait with a *receive* activity for a message from the derived process that the original activity has completed normally.

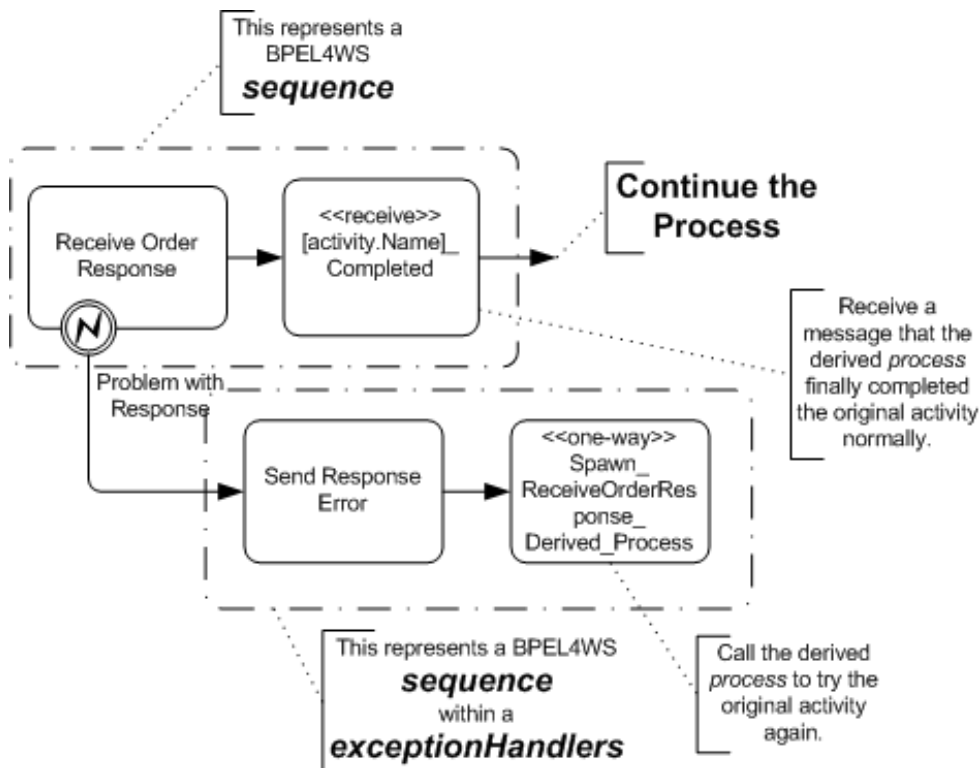

Figure 11.14 - Example of Modification at BPEL4WS level to Handle the Loop

The derived process will be structure much like the corresponding section of the original process (see Figure 11.15). The mappings of the original activities, from the point of the BPMN Process where the Exception Flow loops into the Normal Flow to the point of the source of the Exception Flow, will be in the derived *process*. The same *faultHandlers* will be attached to the scope around the original activity. The *faultHandlers* will also contain a one-way *invoke* to “spawn” itself if the fault occurs again.

When the original activity finally completes normally, one-way *invoke* will be used to send a message back to the original *process* so that normal activities can continue.

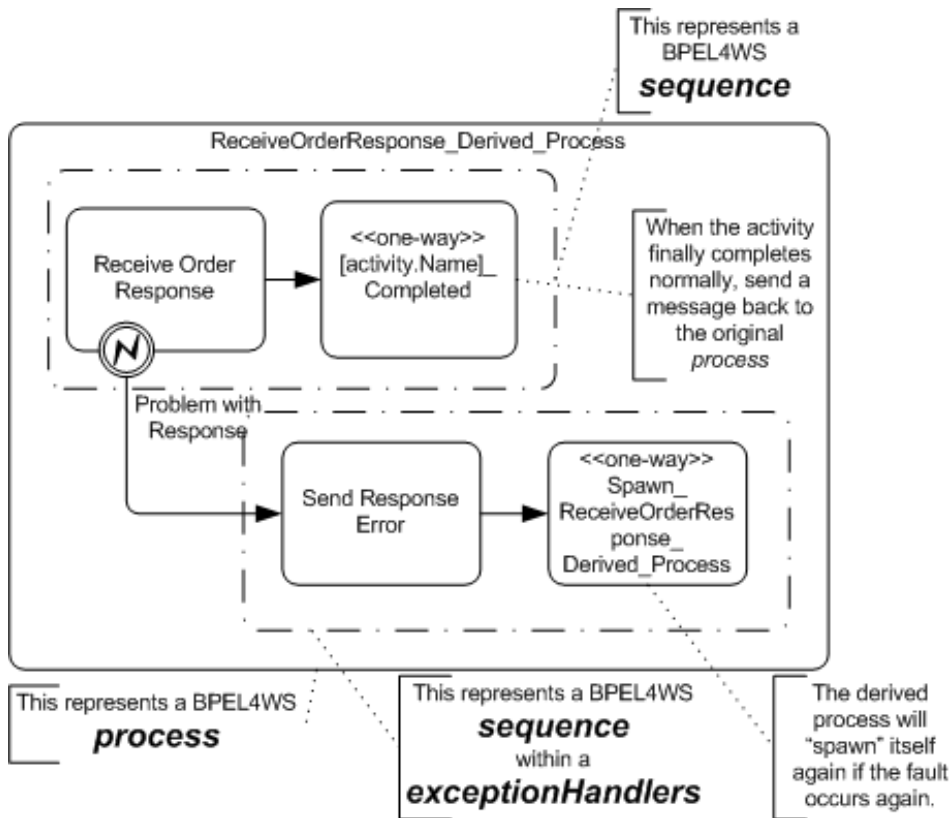

Figure 11.15 - Example of a Derived Process to Handle the Looping

Changes Since 1.0 Draft Version

These are the changes since the last publicly released version:

- The details of the Intermediate Event mappings was moved to the Intermediate Event mapping sections.
- The BPEL4WS mapping related to how the Exception Flow merges back into the Normal Flow was added.

11.14 Compensation Association

The following table displays a set of mappings from a Compensation Association to BPEL4WS elements:

Table 11.46 - Exception Flow Mappings to BPEL4WS

| Compensation Association | Mapping to BPEL4WS |
|--|---|
| A Compensation Intermediate Event attached to an activity boundary | The mapping of the Compensation Event is described in “Compensation Intermediate Events” on page 146. The mapping of the activity Associated with the Intermediate Event will follow the mapping rules defined in Section 11.5.3, “Task Mappings,” on page 168 or in Section 11.5.2, “Sub-Process Mappings,” on page 166 will be placed within the <i>compensationHandler</i> element. |

Changes Since 1.0 Draft Version

These are the changes since the last publicly released version:

- The details of the Compensation Intermediate Event mapping was moved to the Intermediate Event mapping section.
- The description of the mapping was updated to reflect that only a single activity can be associated with a Compensation Intermediate Event that is attached to the boundary of an activity.

11.15 Assignment Mapping

The following table displays a set of mappings from the variations of an Assignment expression to BPEL4WS elements:

Table 11.47 - Assignment Mappings to BPEL4WS

| Assignment | Mapping to BPEL4WS |
|------------|--|
| To | <p>The To attribute will map to the <i>to</i> element of the BPEL4WS <i>assign</i> activity. A variable and supporting WSDL message should have already be created for the Property used in for the Assignment To attribute. Thus, the structure of the to element will be as follows:</p> <p>If the Property is an attribute of a Process:</p> <pre><to variable="[Process.Name]_ProcessData" part="[Property.Name]" /></pre> <p>If the Property is an attribute of an activity:</p> <pre><to variable="[activity.Name]_ActivityData" part="[Property.Name]" /></pre> |
| From | <p>The From expression will map to the <i>from</i> element of the BPEL4WS <i>assign</i> activity.</p> <pre><from expression="[From Expression]" /></pre> |

11.16 BPMN Supporting Type Elements

This section describes the mapping to BPEL4WS of a non-graphical elements that are part of BPMN. Messages, which are linked with Message Flow, do have impact on how many other BPMN elements are mapped to BPEL4WS.

Messages

The following are the mappings of a Message. These mappings are used to create a BPEL4WSE4WS XML file, plus a supporting WSDL supporting file. These mappings are used for a Start Event, End Event, Intermediate Event, and Task:

Table 11.48 - Message Attributes

| Attributes | Description |
|------------|--|
| Name | <p>The Name attribute maps to the <i>name</i> attribute of a BPEL4WS <i>variable</i> element. Note that the extra spaces and non-alphanumeric characters MUST be stripped from the Name to fit with the XML specification of the <i>name</i> attribute. Note that there may be two or more elements with the same name after the BPMN name has been stripped.</p> <p>The <i>messageType</i> attribute of the <i>variable</i> element refers to a WSDL <i>message</i> type definition. Thus, the <i>messageType</i> will share the same Name and a corresponding WSDL <i>message</i> must be created.</p> |

Table 11.48 - Message Attributes

| Attributes | Description |
|------------|--|
| Properties | Each Properties of the BPMN Message will map to a <i>part</i> element of the WSDL <i>message</i> . The Name attribute of the Property will map to the <i>name</i> attribute of the <i>part</i> . The Type attribute of the Property will map to the <i>type</i> attribute of the <i>part</i> . |

11.17 Determining the Extent of a BPEL4WS Structured Element

The structure and vocabulary of BPMN differs from BPEL4WS. BPMN allows flexible, and free-form methods of connecting activities through Sequence Flow. Furthermore, BPMN is cyclical in that it allows Sequence Flow to connect to upstream objects so that a modeler can easily visualize looping situations. BPEL4WS has a much more structured form of creating a process flow. The *flow* activity in BPEL4WS does allow some flexibility with its *link* elements, but is acyclical. Thus, there is not going to be a one-to-one mapping of the BPMN elements to the BPEL4WS elements, without restricting the connection capability of BPMN.

This is particularly true of the BPEL4WS. In BPEL4WS, structure elements, such as *switch*, *pick*, and *while*, have a clear beginning and end. BPMN does not provide specific markers for the start and end of these elements. The exact configuration of the Sequence Flow connections will determine how the Process will be mapped to the BPEL4WS elements.

To determine the appropriate merging and joining points that are needed to construct the structured elements, the configuration of the Process needs to be analyzed. The mechanism we are proposing is called Token Analysis. This involves the creation of a conceptual Token that will “traverse” all the Sequence Flow of the Process. The Token will have a hierarchical TokenId set that will expand/or contract based on the forking and joining and/or splitting and merging that occurs throughout the Process. By matching the TokenId set of Tokens that arrive at objects that have multiple incoming Sequence Flow, it will be possible to determine the boundaries of execution language structured activities.

A BPMN Gateway will usually indicate the start of a BPEL4WS structured element, but even this may not be one-to-one if there are loops involved. The end of the BPEL4WS structured element is even less obvious, since it could be marked by the convergence of Sequence Flow into most types of BPMN elements.

The following sections will describe how different BPMN configurations will map to the BPEL4WS structure elements and show how conceptual Tokens can be used to determine the extent of the BPEL4WS elements.

Identifying the Start of a BPEL4WS Element

The most basic structured element of BPEL4WS is the sequence.

- ◆ If the *process*, or the activity of a structured element (e.g., a *switch case*), contains more than one activity, then it is likely a *sequence* will be needed. Nearly any set of activities connected by Sequence Flow, which is not going to be mapped to the contents of a *flow*, will be contained within a *sequence*. The *sequence* will envelope all the remaining elements to the extent of the context in which the *sequence* exists. For example, the *sequence* will extend the length of the *process*, or the length of a *switch case*, etc.

For the other types of BPEL4WS elements, their extend is determined by tracing through the Process with conceptual Tokens:

- ◆ First the start of the BPEL4WSE4WS structured element (e.g., *flow*, *switch*, *pick*, etc.) must be identified. This is done by performing the mapping of the BPMN elements, starting with the Start Event or first element(s) if there is no Start Event, and proceeding down the Sequence Flow. The start of the structured element is usually a Gateway or if an activity has multiple outgoing Sequence Flow (see Figure 11.16 and Figure 11.18).

- ◆ Note that some structured elements (mainly a *sequence*, but including others such as a *switch*) are needed for mapping a particular BPMN activity (as described in the sections above). In these cases, the extent of these structured elements are known.

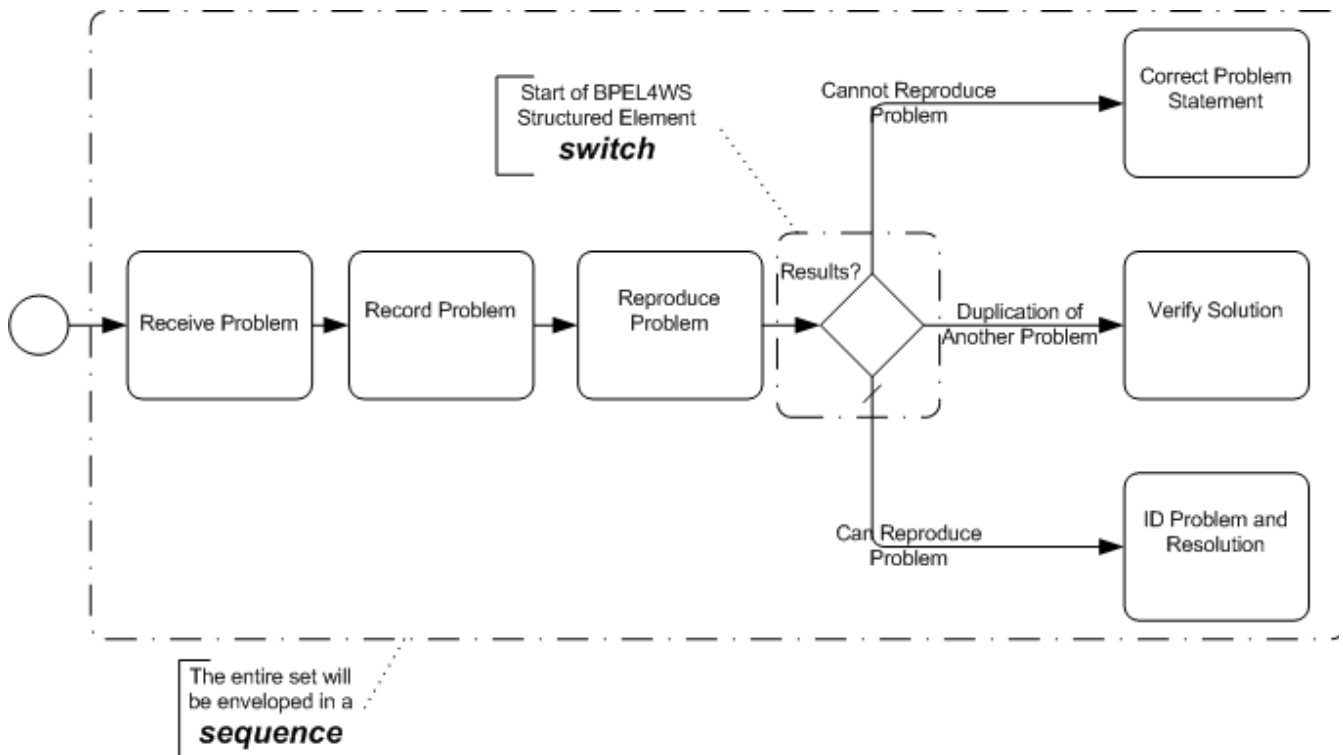

Figure 11.16 - Identification of BPEL4WS structured element

- ◆ The number paths that make up the structured element MUST be determined. To do this, the all outgoing paths from the location of the structured element will be identified. A conceptual Token can be used to trace the paths. The Tokens are given an Id that uniquely identifies the precedent of the structure element being determined and the number of paths being traced for that element (see Figure 11.17).

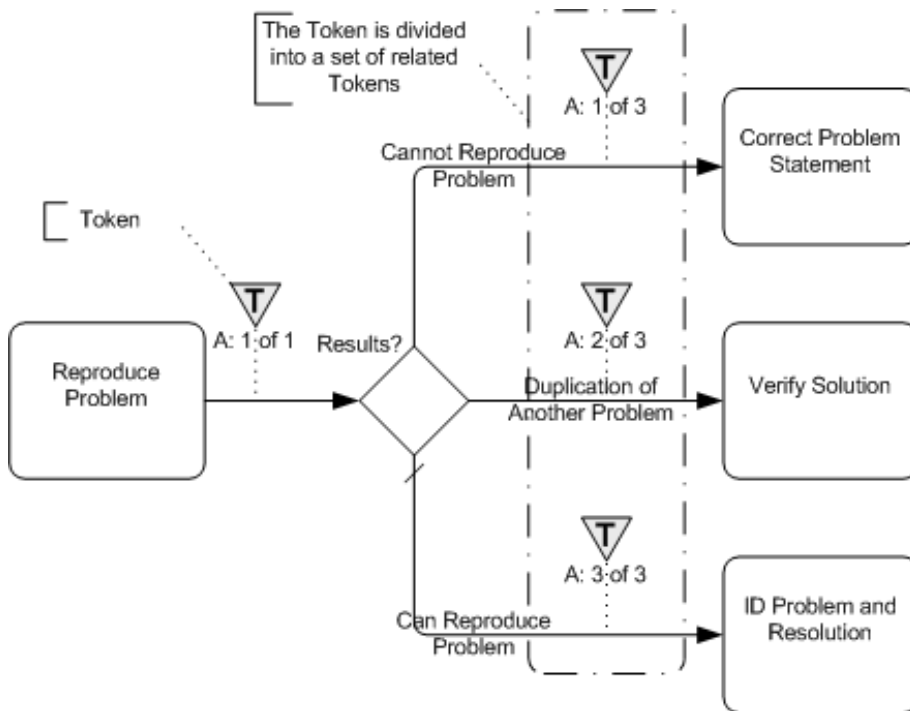

Figure 11.17 - The Creation of Related Tokens

Finding the End of a BPEL4WS Element

The end of a BPEL4WS structured element will be found when all the paths, which were identified at the start of the element, have converged.

- ◆ Trace each path until there is a merge or join with all the other paths. When all the Tokens with the appropriate Ids arrive at the same BPMN object and can be recombined, then the structured element **SHALL** be closed (see Figure 11.18).

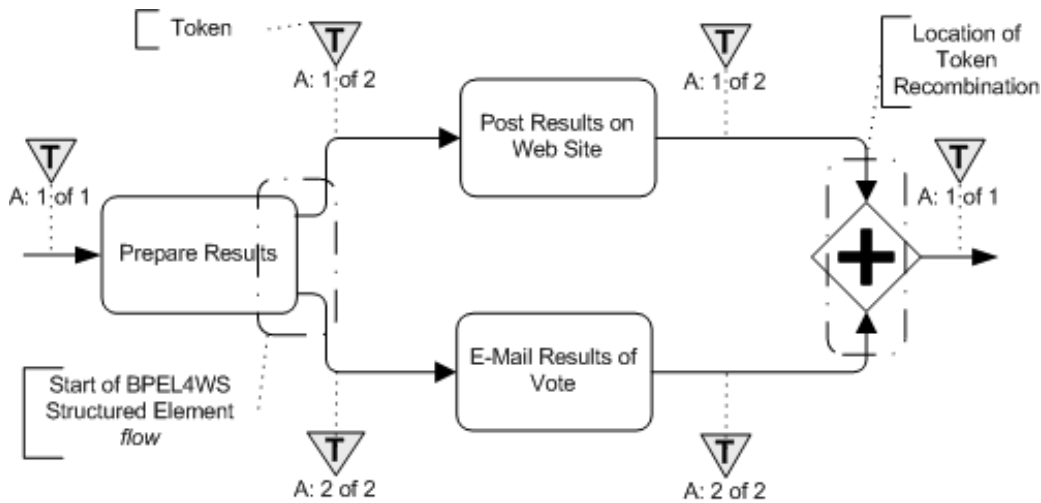

Figure 11.18 - Example of Recombination of Tokens

- ◆ There MAY be partial recombinations of the Tokens prior to the final recombination. In this case, one Token will contain all the identities of the Tokens that have been merged (see Figure 11.19). Note that partial recombination of a Token creates another mapping issue that is described in Section 11.17.1, “BPMN Elements that Span Multiple BPEL4WS Sub-Elements,” on page 201.

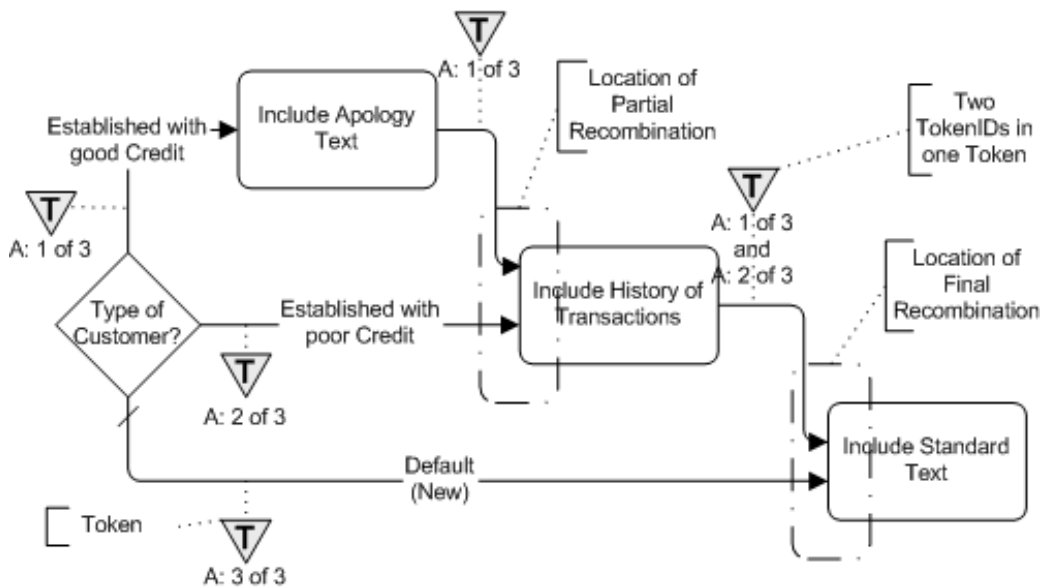

Figure 11.19 - Example of Partial Recombination of Tokens

- ◆ End Events can be combined with other BPMN objects to complete the merging or joining of the paths of a BPEL4WS structured element (see Figure 11.20).

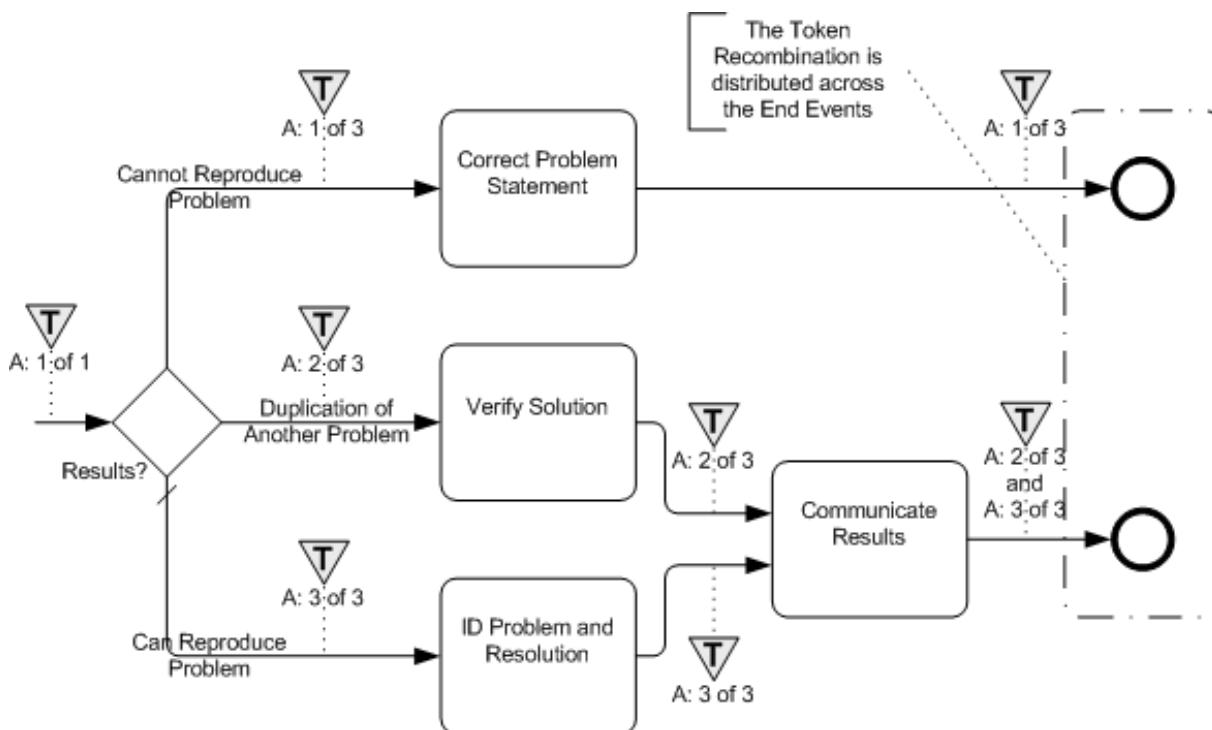

Figure 11.20 - Example of Distributed Token Recombination

Nested Elements

Another structured element may occur before the first structure element is closed.

- ◆ If another structured element is encountered before all the paths are merged (see Figure 11.21), then the tracing of the first element **MUST** be stopped and the tracing of the paths of the second element **MUST** begin. The extent of the second element **MUST** be determined before the extent of the first element can be determined.
- ◆ This process **MUST** be repeated if other structured elements are encountered during the tracing of any paths of structured elements.

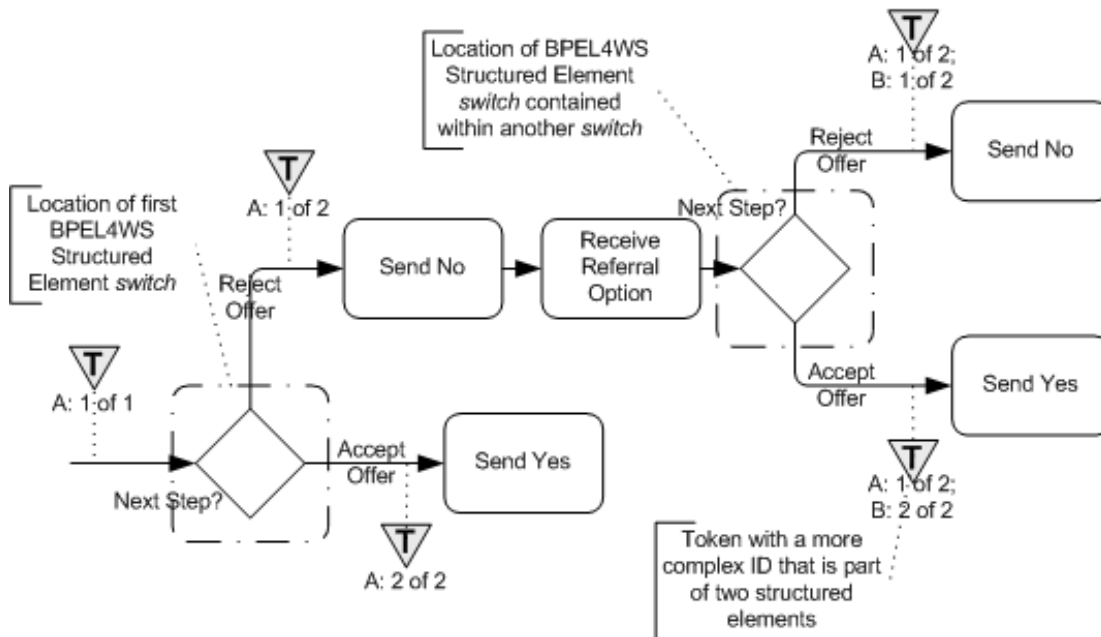

Figure 11.21 - Example of nested BPEL4WS structural elements

Handling Loops

Loops are created when the flow of the Process moves from a downstream object to an upstream object.

- ◆ If one of the paths arrives at a BPMN object that is upstream from the source of the structured element, then this SHALL create a looping situation. How the loop is handled depends on the type structured element is being traced and how many paths are included in the element.

The following sections will describe the mapping for the different type of loop configurations.

Simple Loop From a Gateway

This type of loop is created by a Gateway that has only two outgoing Sequence Flow. One Sequence Flow continues downstream and the other loops back upstream (see Figure 11.22). Note that there might be intervening activities prior to when the Sequence Flow loops back upstream.

- ◆ This will map to a BPEL4WS *while* activity.
 - ◆ The Condition for the Sequence Flow that loops back upstream will map to the *condition* of the *while*.
 - ◆ All the activities that span the distance between where the loop starts and where it ends, will be mapped and placed within the activity for the *while*, usually within a *sequence*.

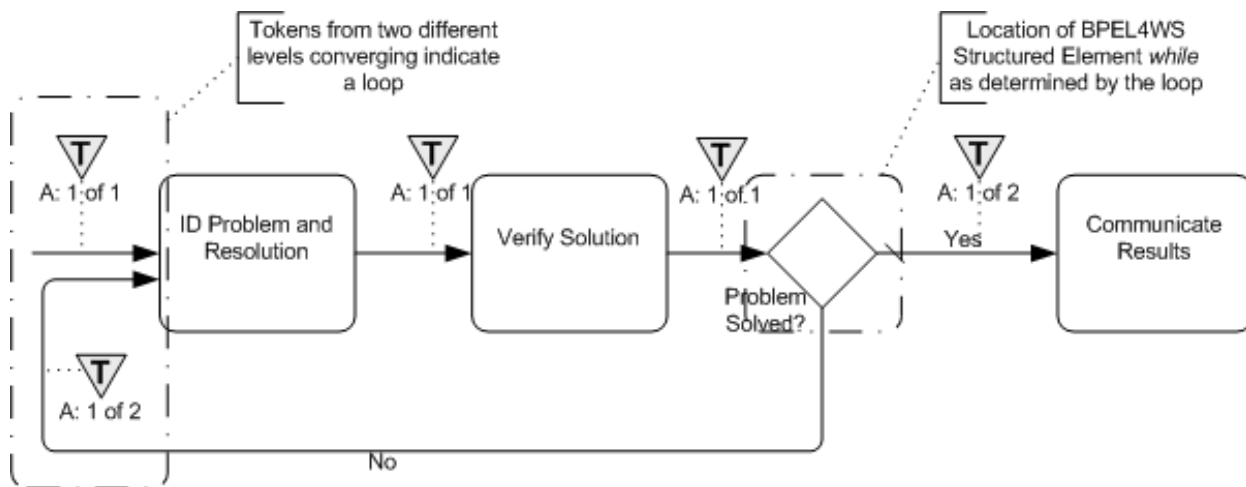

Figure 11.22 - Example of a Loop from a Decision with Two Alternative Paths

Loop/Switch Combinations From a Gateway

This type of loop is created by a Gateway that has three or more outgoing Sequence Flow. One Sequence Flow loops back upstream while the others continue downstream (see Figure 11.23). Note that there might be intervening activities prior to when the Sequence Flow loops back upstream.

- ◆ This maps to both a BPEL4WS *while* and a *switch*. Both activities will be placed within a *sequence*, with the *while* preceding the *switch*.
 - ◆ For the *while*:
 - ◆ The Condition for the Sequence Flow that loops back upstream will map to the *condition* of the *while*.
 - ◆ All the activities that span the distance between where the loop starts and where it ends, will be mapped and placed within the activity for the *while*, usually within a *sequence*.
 - ◆ For the *switch*:
 - ◆ For each additional outgoing Sequence Flow there will be a *case* for the *switch*. The details for mapping to a switch from a Gateway can be found in Section 11.6, “Gateways,” on page 171.

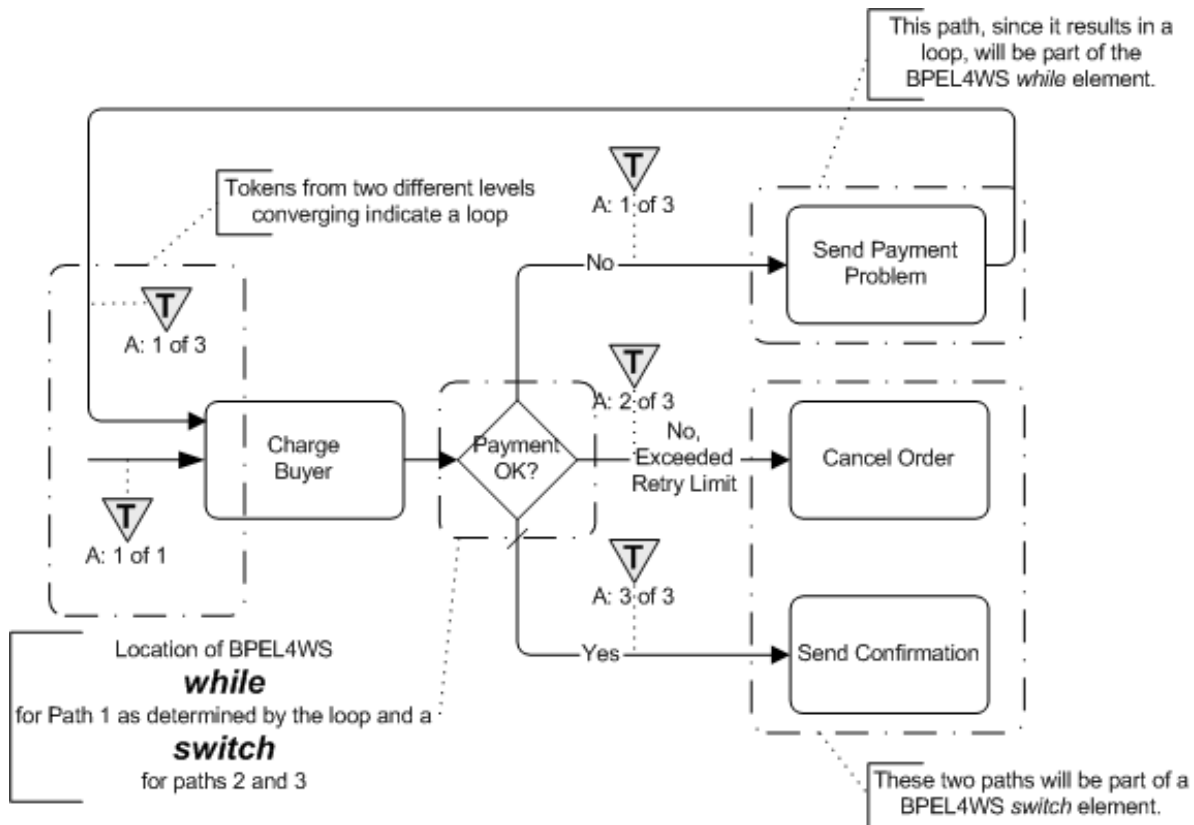

Figure 11.23 - Example of a Loop from a Decision with more than Two Alternative Paths

Interleaved Loops

This is a situation where there at least two loops involved and they are not nested (see Figure 11.24). Multiple looping situations can map, as described above, if they are in a sequence or are fully nested (e.g., one *while* inside another *while*). However, if the loops overlap in a non-nested fashion, as shown in Figure 11.24, then the structured element *while* cannot be used to handle the situation. Also, since a *flow* is acyclic, it cannot handle the behavior either.

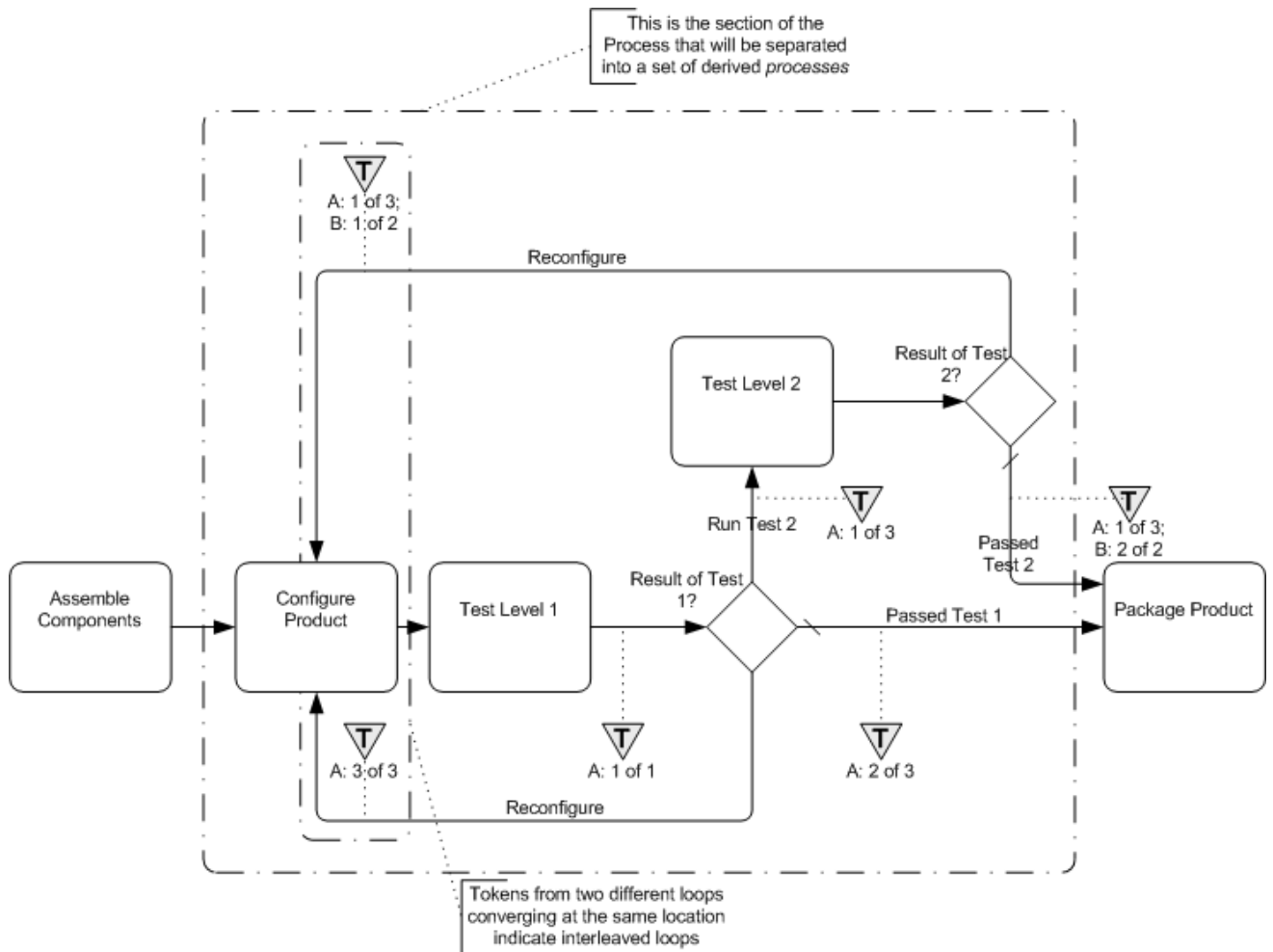

Figure 11.24 - Example of Interleaved Loops

To handle this type of behavior, parts of the BPEL4WS *process* will have to be separated into one or more derived *processes* that are spawned from the main *process* and will also spawn or call each other (note that the examples below are using a spawning technique). Through this mechanism, the linear and structured elements of BPEL4WS can provide the same behavior that is shown through a set of cycles in a single BPMN diagram. To do this:

- ◆ The looping section of the process, where the loops first merge back (upstream) into the flow until all the paths have merged back to Normal Flow, shall be separated from the main *process* into a set of derived *processes* that will spawn each other until all the looping conditions are satisfied.
- ◆ The section of the Process that is removed will be replaced by a (one-way) *invoke* to spawn the derived *process*, followed by a *receive* to accept the message that the looping sections have completed and the main *process* can continue (see Figure 11.25).
 - ◆ The name of the *invoke* will be in the form of:
 - ◆ “Spawn_[(loop target)activity.Name]_Derived_Process”
 - ◆ The name of the *receive* will be in the form of:
 - ◆ “[(loop target)activity.Name]_Derived_Process_Completed”

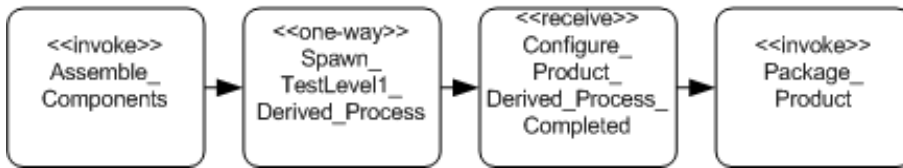

Figure 11.25 - Example of the BPEL4WS Pattern for Substituting for the Derived Process

- ◆ For each location in the Process where a Sequence Flow connects upstream, there will be a separate derived BPEL4WS process.
 - ◆ The name of the derived process will be in the form of:
 - ◆ “[([loop target)activity.Name]_Derived_Process”
 - ◆ All Gateways in this section will be mapped to *switch* elements, instead of *while* elements (see Figure 11.26).
 - ◆ Each time there is a Sequence Flow that loops back upstream, the activity for the *switch* case will be a (one-way) *invoke* that will spawn the appropriate derived process, even if the *invoke* spawns the same process again.
 - ◆ The name of the *invoke* will be the same as the one describe above.
 - ◆ At the end of the derived process a (one-way) *invoke* will be used to signal the main process that all the derived activity has completed and the main process can continue.
 - ◆ The name of the *invoke* will be in the form of:
 - ◆ “[([loop target)activity.Name]_Derived_Process_Completed”

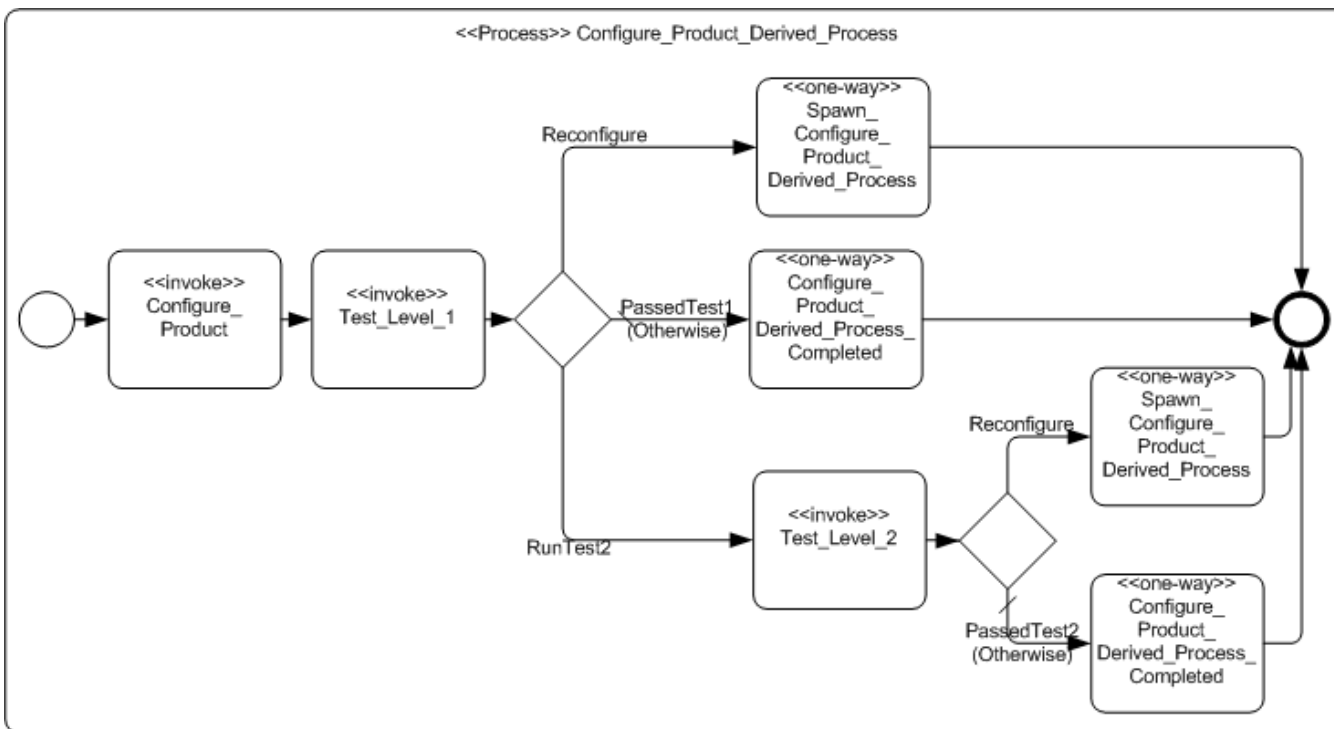

Figure 11.26 - Example of a BPEL4WS Pattern for the Derived Process

Infinite Loops

This type of loop is created by a Sequence Flow that loops back without an intervening Gateway to create alternative paths (see Figure 11.27). While this may be a modeling error most of the time, there may be situations where this type of loop is desired, especially if it is placed within a larger activity that will eventually be interrupted.

- ◆ This will map to a *while* activity.
 - ◆ The condition of the while will be set to an expression that will never evaluate to True, such as condition "1 = 0."
 - ◆ All the activities that span the distance between where the loop starts and where it ends, will be mapped and placed within the activity for the *while*, usually within a *sequence*.

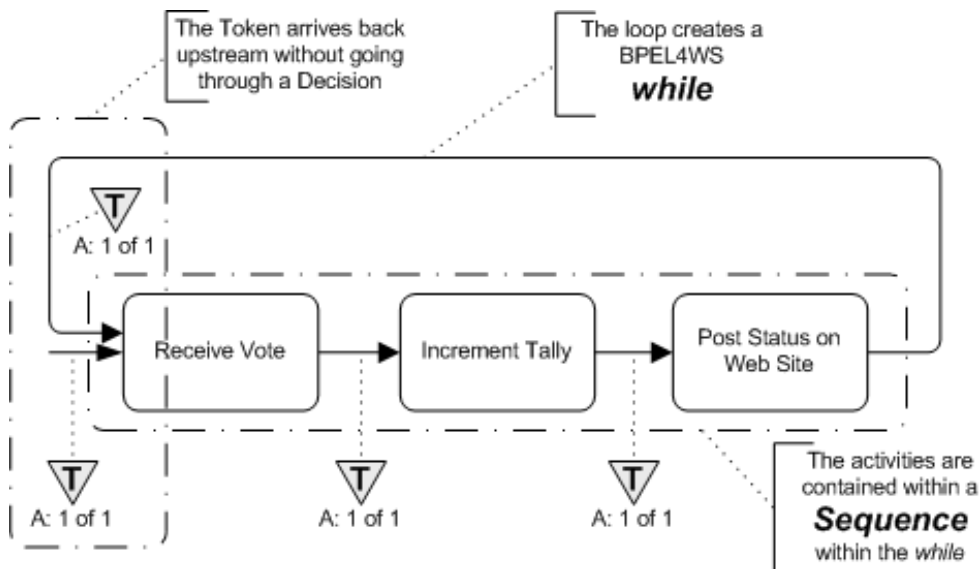

Figure 11.27 - Example: An Infinite Loop

Handling Link Events as Go To Objects

As was seen in Figure 10.44, Figure 10.45, and Figure 10.46, Link Intermediate Events can be used as Go To Objects. The basic impact of using them in such a way is that they are a substitute using a single, longer Sequence Flow to make the same connection between two objects. Thus, the mapping to BPEL4WS should be done by considering them as just a single Sequence Flow. This means that the Intermediate Events are not mapped to any BPEL4WS element. Instead a conceptual Sequence Flow will be used, with the Source and Target of that Sequence Flow being the Source of the Sequence Flow going into the Source Link Event and the Target of the Sequence Flow coming out of the Target Link Event (see Figure 11.28). The mapping at this point can done using all the mapping consideration described in this Chapter.

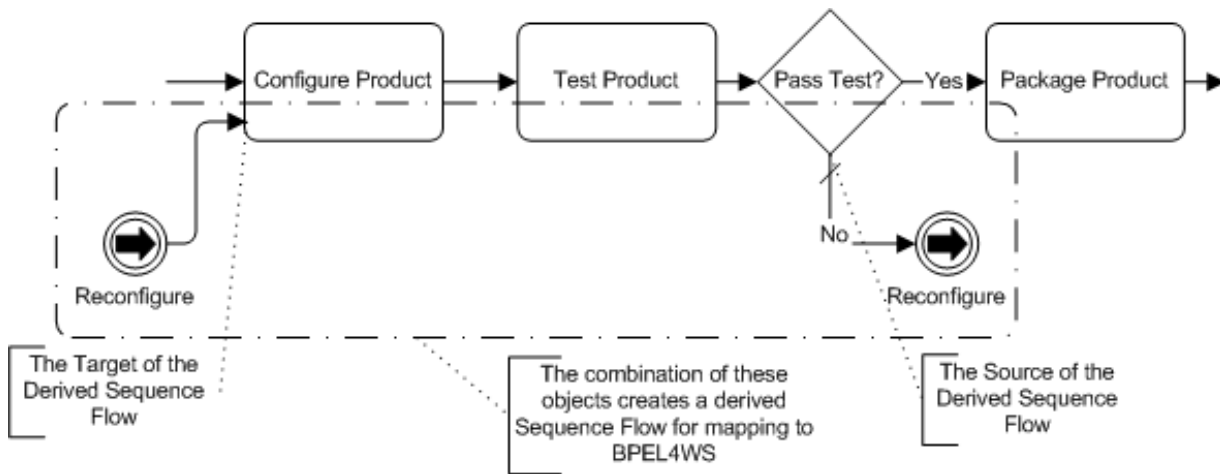

Figure 11.28 - Example: A Pair of Go To Link Events are Treated as a Single Sequence Flow

Changes Since 1.0 Draft Version

These are the changes since the last publicly released version:

- The details of this section were added.

11.17.1 BPMN Elements that Span Multiple BPEL4WS Sub-Elements

Figure 11.19 is repeated below in Figure 11.29 to illustrate how BPMN objects may exist in two separate sub-elements of a BPEL4WS structured element at the same time. Since BPMN allows free form connections of activities and Sequence Flow, it is possible that two (or more) Sequence Flow will merge before all the Sequence Flow that map to a BPEL4WS structure element have merged. The sub-elements of a BPEL4WS structured elements are also self contained and there is no cross sub-element flow. For example, the *cases* of a *switch* cannot interact; that is, they cannot share activities. Thus, one BPMN activity will need to appear in two (or more) BPEL4WS structured elements.

There are two possible mechanisms to deal with the situation.

- ◆ First, the activities are simply duplicated in all appropriate BPEL4WS elements.
- ◆ Second, the activities that need to be duplicated can be removed from the main process and placed in a derived process that is called (*invoked*) from all locations in the BPEL4WS elements as required.
 - ◆ The name of the derived process will be in the form of:
 - ◆ “[*(target)*object.Name]_Derived_Process”

In Figure 11.29 displays this issue with an example. In that example, two Sequence Flow merge into the “Include History of Transactions” Task. However, the Decision that precedes the Task has three (3) alternatives. Thus, the Decision maps to a BPEL4WS *switch* with three (3) *cases*. The three cases are not closed until the “Include Standard Text” Task, downstream. This means that the “Include History of Transactions” Task will actually appear in two (2) of the three (3) *cases* of the *switch*.

Note – the use of a BPEL4WS *flow* will be able to handle the behavior without duplicating activities, but a *flow* will not always be available for use in these situations, particularly if a BPEL4WS *pick* is required.

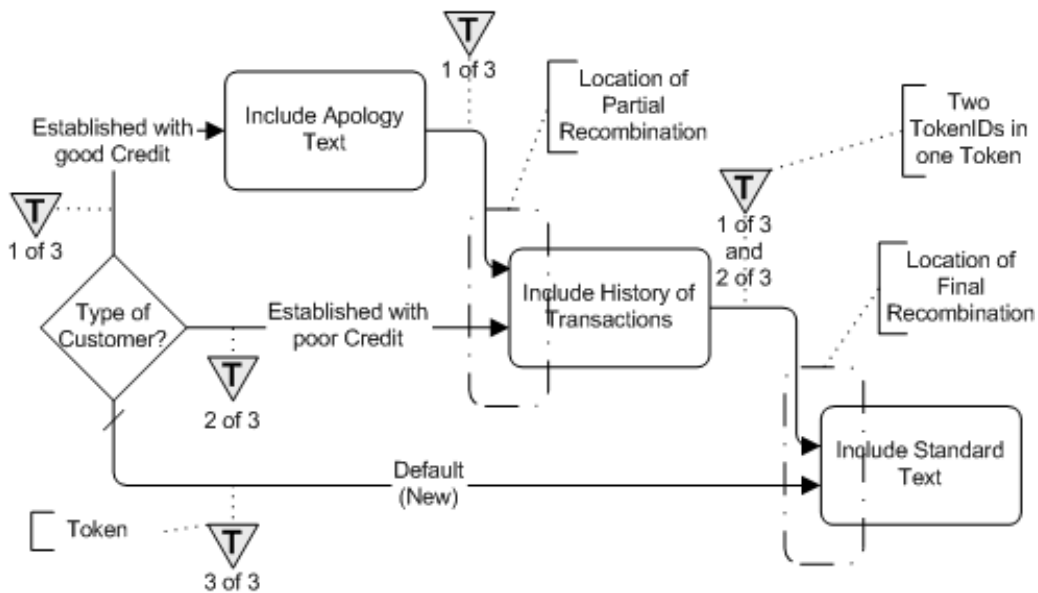

Figure 11.29 - Example: Activity that spans two paths of a BPEL4WS Structured Element

Example 11.8 displays some sample BPEL4WS code that reflects the portion of the Process that was just discussed and is shown in Figure 11.29. Note that there are two *invoke* elements that have the same *name* attribute (“IncludeHistoryofTransactions”).

```

<!--Continue with the process-->
<switch name="TypeofCustomer">
  <!-- name="Established with Good Credit" -->
  <case condition="bpws:getVariableProperty(ProcessData,CreditType)>"Yes, Good" ">
    <invoke name="IncludeApologyText" ...>
    <!--This also exists in the other case-->
    <invoke name="IncludeHistoryofTransactions" ...>
  </case>
  <!--name="Established with poor Credit" -->
  <case condition="bpws:getVariableProperty(ProcessData,CreditType)>"Yes, Poor" ">
    <!--This also exists in the other case-->
    <invoke name="IncludeHistoryofTransactions" ...>
  </case>
  <!--name="Default (New)" -->
  <otherwise>
    <!--Nothing happens here-->
    <empty/>
  </otherwise>
</switch>
<invoke name="IncludeStandardText" ...>
<!--Continue with the process-->

```

Example 11.8 - Example: BPMN Elements that Span Multiple BPEL4WS Sub-Elements

Changes Since 1.0 Draft Version

- This section was added.

12 BPMN by Example

This section will provide an example of a business process modeled with BPMN. The process that will be described is a process that BPMI has been using to develop this notation. It is a process for resolving issues through e-mail votes (see Figure 12.1). This Process is small, but fairly complex and will provide examples for many of the features of BPMN. There are some unusual features of this business process, such as infinite loops. Although not a typical process, it will help illustrate that BPMN can handle simple and unusual business processes and still be easily understandable for readers of the Diagram. The sections below will isolate segments of the Process and highlight the modeling features as the workings of the Process is described. In addition, samples of BPEL4WS code are provided to demonstrate how a BPMN Diagram maps to BPEL4WS.

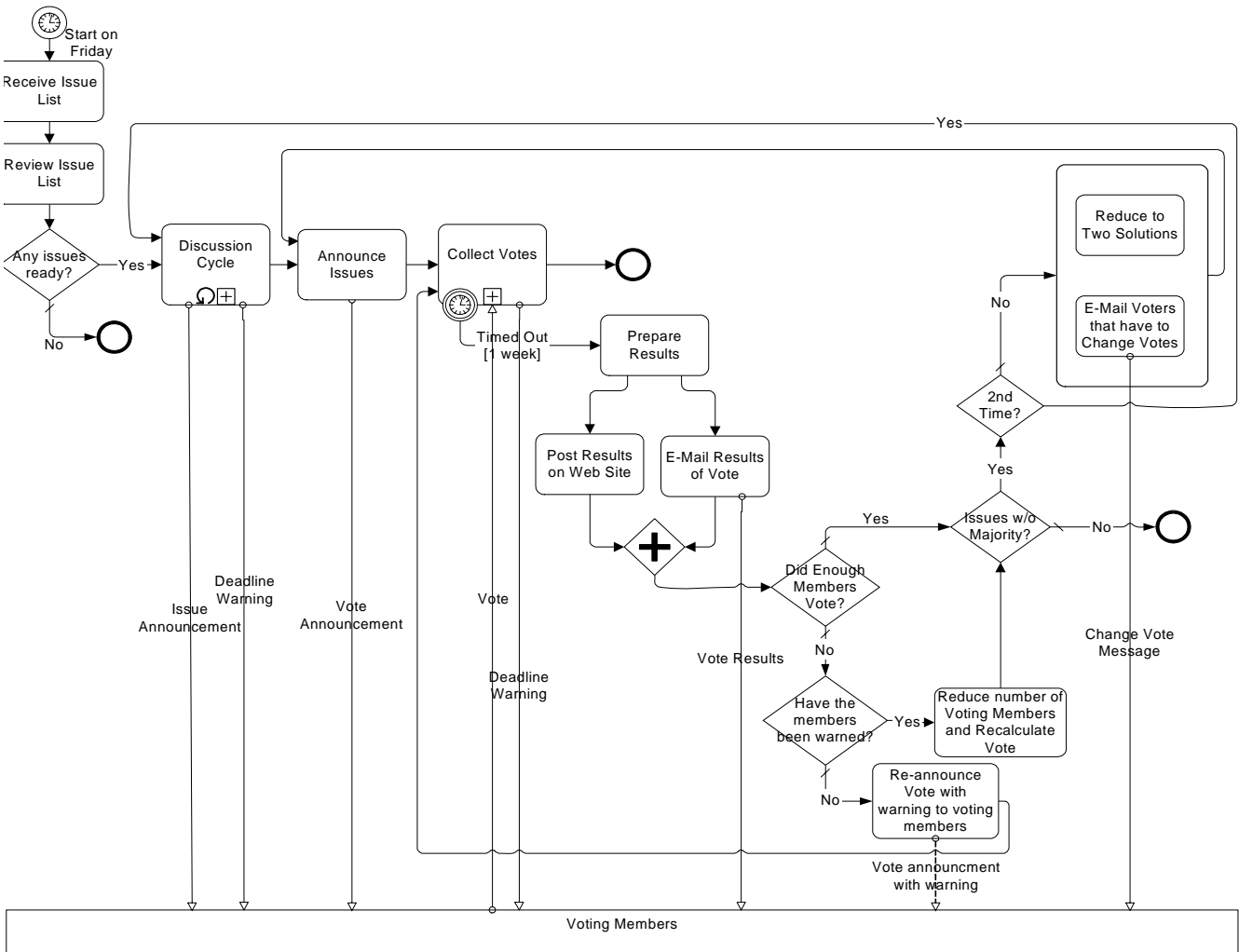

Figure 12.1 - E-Mail Voting Process

The Process has a point of view that is from the perspective of the manager of the Issues List and the discussion around this list. From that point of view, the voting members of the working group are considered as external Participants who will be communicated with by messages (shown as Message Flow).

12.1 The Beginning of the Process

The Process starts with Timer Start Event that is set to trigger the Process every Friday (see Figure 12.2).

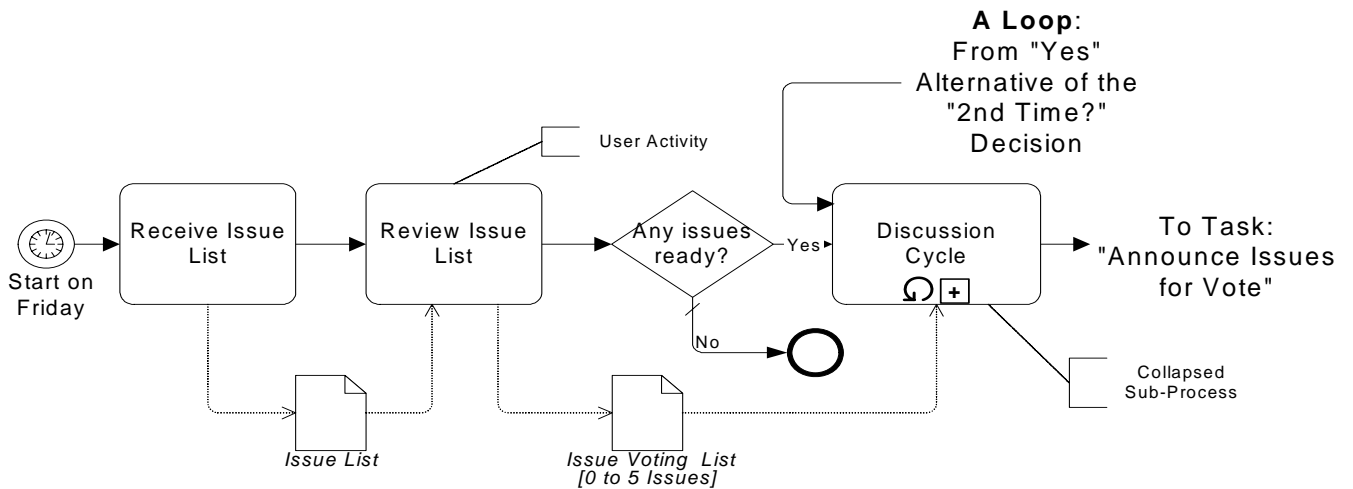

Figure 12.2 - The Start of the Process

The Issue List Manager will review the list and determine if there are any issues that are ready for going through the discussion and voting cycle. Then a Decision must be made. If there are no issues ready, then the Process is over for that week--to be taken up again the following week. If there are issues ready, then the Process will continue with the discussion cycle. The “Discussion Cycle” Sub-Process is the first activity after the “Any issues ready?” Decision and this Sub-Process has two incoming Sequence Flow, one of which originates from a downstream Decision and is thus part of a loop. It is one of a set of five complex loops that exist in the Process. The contents of the “Discussion Cycle” Sub-Process and the activities that follow will be described below.

12.1.1 Mapping to BPEL4WS

BPEL4WS *processes* must begin with a *receive* activity for instantiation (i.e., it “bootstraps” itself). The “E-Mail Voting Process” is scheduled to start every Friday as shown by the Timer Start Event. Therefore, an additional Process will have to be created and implemented that will run indefinitely and will send a starting message with the list of Issues to the “E-Mail Voting Process” every Friday. Figure 12.3 shows this Process as starting that the beginning of the Working Group and continuing until the end of the Working Group. Even this Process needs a message to be sent to it to signal the start of the Working Group. There may be another Process defined that sends that message, but that Process is not shown here. In addition, the mapping from the Starter Process to BPEL4WS is not shown here.

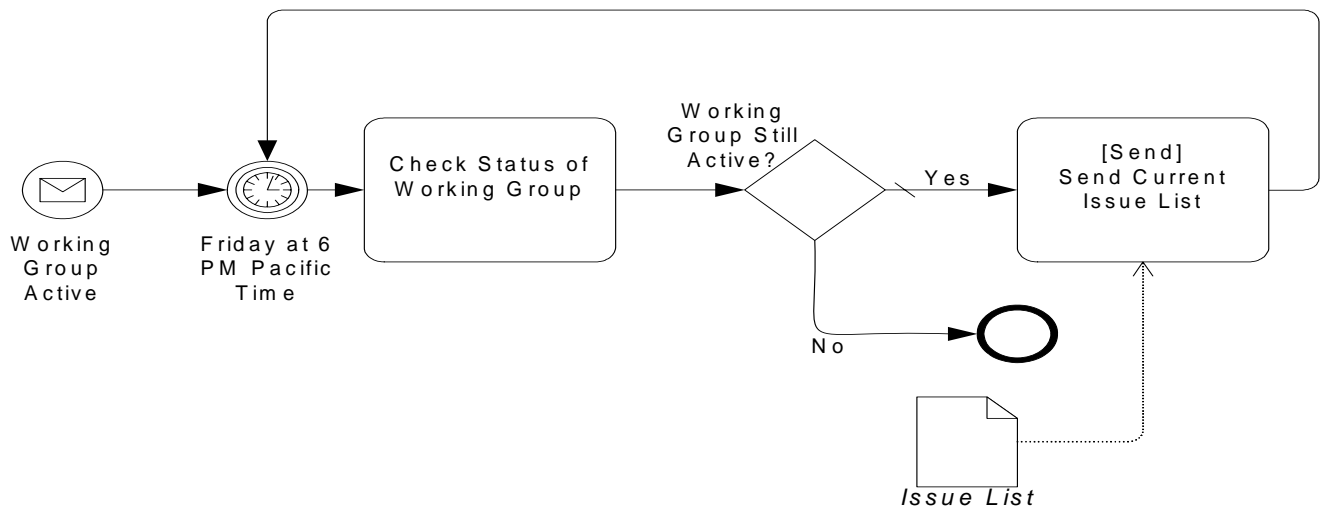

Figure 12.3 - The Ongoing Starter Process

- Within the main Process (see Figure 12.2), the “Receive Issue List” Task will map to a BPEL4WS *receive* that has its *createInstance* attribute set to “yes.” This will receive starting message and start the *process*.
- This *receive* will be placed inside a *sequence* since other activities follow the activity. The *message* to be received will contain all the *variable parts* that will be used in the *process* and their initialized values.

Note – the names of BPD objects have all non-alphanumeric characters stripped from them when they are mapped to BPEL4WS *name* elements to match the BPEL4WS element restrictions.

The modeler-defined properties of the Process will be placed in a BPEL4WS *variables* element named “processData.” The same *variables* element will be used in all derived *processes* in this example.

- The “Review Issue List” Task will map to a BPEL4WS *invoke*. This TaskType is User, which means that the *invoke* will be synchronous and an *outputVariable* included.

Mapping an Exclusive Gateway (Decision)

- The “Any Issues Ready?” Exclusive Gateway (Decision) will map to a BPEL4WS *switch*.
- The Gate for the “No” Sequence Flow will map to the *otherwise case* of the *switch*. This *otherwise* will only contain an *empty activity* since there is nothing to do and the Process is over.

Note that *empty* does not have any corresponding activity in the BPMN Diagram, but is derived through the Diagram configuration.

- The Gate for the “Yes” Sequence Flow will map to other *case* for the *switch*. This *case* will have a *condition* that checks the number of issues that are ready. This *case* will handle the remainder of the Process that is shown in Figure 12.1.

This is done because the *switch* is a block structure and needs a definitive ending point and since the *otherwise* is connected to the end of the Process, then the end of the Process is the ending point that the *case* must use. The actual activities that make up the rest of the Process will be distributed among a set of BPEL4WS *processes* instead of all being

within the *case*. The *case* will only contain an *invoke* that will call another *process* (as a web service). The distribution of the Process activities is due to the overall Diagram configuration that includes three upstream Sequence Flow that define some interleaving loops.

The Impact of Interleaved Loops

If the loop shown in this section of the model were merely a simple loop, and perhaps the only loop, then a BPEL4WS *while* would be used to handle the loop. In this situation, though, the looping is handled through a set of derived *processes* that are accessed by *invoking* them (as a web service). There would no specific Diagram element to represent these derived *processes*; indeed, a modeler would not want to create a set of related Processes to handle complex looping. While an execution engine can easily handle a complex set of language documents and elements, a business person developing and monitoring this process will want to see the Process in an easy-to-read format (such as BPMN) that contains the information in a more comprehensive, less distributed format. See “Interleaved Loops” on page 197 for details about how interleaved loops are mapped to BPEL4WS.

In this example, all derived *processes* will be named “[target of loop) activity.Name]_Derived_Process.” Any naming scheme will work as long as all the *processes* have unique names.

- Thus, to handle the rest of the Process, a derived *nested process* named “Discussion_Cycle_Derived_Process” is created and then
- A BPEL4WS *invoke* is used to access this *process* from the “Yes” *case* of the “Any issues ready?” *switch*.

We shall see that later in the Process the same *process* is accessed through another *invoke*, marking the source of the loop.

All the sub-processes and derived processes in the BPEL4WS documents must be started with the *receive* of a message and then a *reply* to send a message back to the calling *process*.

- This means that a *receive* will be the first *activity* inside a *sequence* that will be the main *activity* of these *processes*. These *receive* activities will have the *createInstance* attribute set to “Yes.” A named “internal,” a portType name “processPort” will be created to support all of these process to process communications. The WSDL operations that will support these communications will all be named “call_<process name>” (as noted above, the processes are actually spawned).

The “Discussion Cycle” Sub-Process shown in Figure 12.2 will continue the *sequence* (after the instantiating *receive*) for the “Discussion_Cycle_Derived_Process” *process*.

- Since “Discussion Cycle” is a Sub-Process it will map to a separate BPEL4WS *process* that is access through an *invoke*.

Mapping an Activity Loop Condition

The “Discussion Cycle” Process has a loop marker. In this situation, the looping mechanism is simple. The attributes of the Sub-Process will tell us the details. The “Discussion Cycle” Sub-Process’s relevant attributes are: LoopType: “Standard”; LoopCondition: DiscussionOver = “FALSE”; and TestTime: “After.”

- This means that the *invoke* that calls the *process* will be enclosed within a *while* activity when the BPEL4WS is derived.
 - The LoopType will map to a BPEL4WS *while*. The LoopCondition of the Process (as shown above) will map to the “DiscussionOver = False” will be the condition for the *while*.

The default value for the “DiscussionOver” property is False, thus an activity within the Sub-Process will have to change it to True before the *while* loop is over. The logical opposite of the expression that is shown in the Sub-Process attributes is used since the EvaluationCondition property is “after.” However, a *while* will test the condition prior to running the activity within. This means that to insure that the activity is always performed at least once (to mimic the behavior of an “until”) a LoopCounter variable will always be added to a the while condition for an BPMN activity that has its TestTime attribute set to “After.”

- The LoopCounter will be initialized to zero, and an *assign* will be added to the *sequence* prior to the *while* element.
- The *activity* of the *while* will be changed to a *sequence*, with the *invoke* for the Sub-Process, which is
 - Followed by an *assign* that will increment the LoopCounter variable, inside the *sequence*.

We will look into the details of the “Discussion Cycle” Sub-Process in Section 12.2, “The First Sub-Process,” on page 211.

BPEL4WS Sample for the Beginning of the Process

Example 12.1 displays some sample BPEL4WS code that reflects the portion of the Process that was just discussed and is shown in Figure 12.2.

```

<process name="EMailVotingProcess">
  <!-- The Process data is defined first-->
  <sequence>
    <!--This starts the beginning of the Process. The process that sends the
      starting message every Friday is related to the Timer Start Event and is
      not shown here.-->
    <receive partnerLink="Internal" portType="tns:processPort"
      operation="receiveIssueList" variable="processData" createInstance="Yes"/>
    <invoke name="ReviewIssueList" partnerLink="Internal"
      portType="tns:internalPort" operation="sendIssueList"
      inputVariable="processData" outputVariable="processData"/>
    <switch name="Anyissuesready">
      <!-- name="Yes" -->
      <case condition="bpws:getVariableProperty(ProcessData,NumIssues)>0">
        <!--A chunk of this process is separated into a derived process so that it can be
          called from a complex loop. Thus, it is called from here and from "Collect Votes"
          as part of a loop-->
        <invoke name="Discussion_Cycle_Derived_Process" partnerLink="Internal"
          portType="tns:processPort"
          operation="call_Discussion_Cycle_Derived_Process" inputVariable="processData"
          outputVariable="processData"/>
      </case>
      <!--name="No" -->
      <otherwise>
        <!--This is one of the two ways to the end of the Process-->
        <empty/>
      </otherwise>
    </switch>
  </sequence>
</process>

<process name="Discussion_Cycle_Derived_Process">
  <!-- The Process data is defined first-->
  <sequence>
    <receive partnerLink="Internal" portType="tns:processPort"
      operation="call_Discussion_Cycle_Derived_Process" variable="processData"
      createInstance="Yes"/>
    <!--The first Sub-Process has a loop condition, so it is within a while-->
    <assign name="Discussion_Cycle_initialize_loopCounter">
      <copy>
        <from expression="0"/>
        <to variable="Discussion_Cycle_loopCounter" part="loopCounter" />
      </copy>
    </assign>
    <!--Since the TestTime is "After" the Sub-Process has to be performed before the
      while-->
    <invoke name="Discussion_Cycle" partnerLink="Internal"

```

```

        portType="tns:processPort operation="call_Discussion_Cycle"
        inputVariable="processData" outputVariable="processData"/>
<while condition="bpws:getVariableProperty(ProcessData,DiscussionOver)=false">
  <!--This calls the first Sub-Process-->
  <sequence>
    <invoke name="Discussion_Cycle" partnerLink="Internal"
      portType="tns:processPort operation="call_Discussion_Cycle"
      inputVariable="processData" outputVariable="processData"/>
    <assign>
      <copy>
        <from expression=
          "bpws:getVariableProperty(Discussion_Cycle_loopCounter,LoopCounter)+1"/>
        <to variable="Discussion_Cycle_loopCounter" part="LoopCounter"/>
      </copy>
    </assign>
  </sequence>
</while>
<!--This calls the first another derived process to handle the rest of the
work-->
<invoke name="Announce_Issues_Derived_Process" partnerLink="Internal"
  portType="tns:processPort" operation="call_Announce_Issues_Derived_Process"
  inputVariable="processData" outputVariable="processData"/>
<reply partnerLink="Internal" portType="tns:processPort "
  operation="call_Discussion_Cycle_Derived_Process" variable="processData"
  createInstance="Yes"/>
</sequence>
</process>
<!--A lot of other activity follows (not shown)-->

```

Example 12.1 - BPEL4WS Sample for Beginning of E-Mail Voting Process

12.2 The First Sub-Process

Figure 12.4 shows the details of the “Discussion Cycle” as an Expanded Sub-Process.

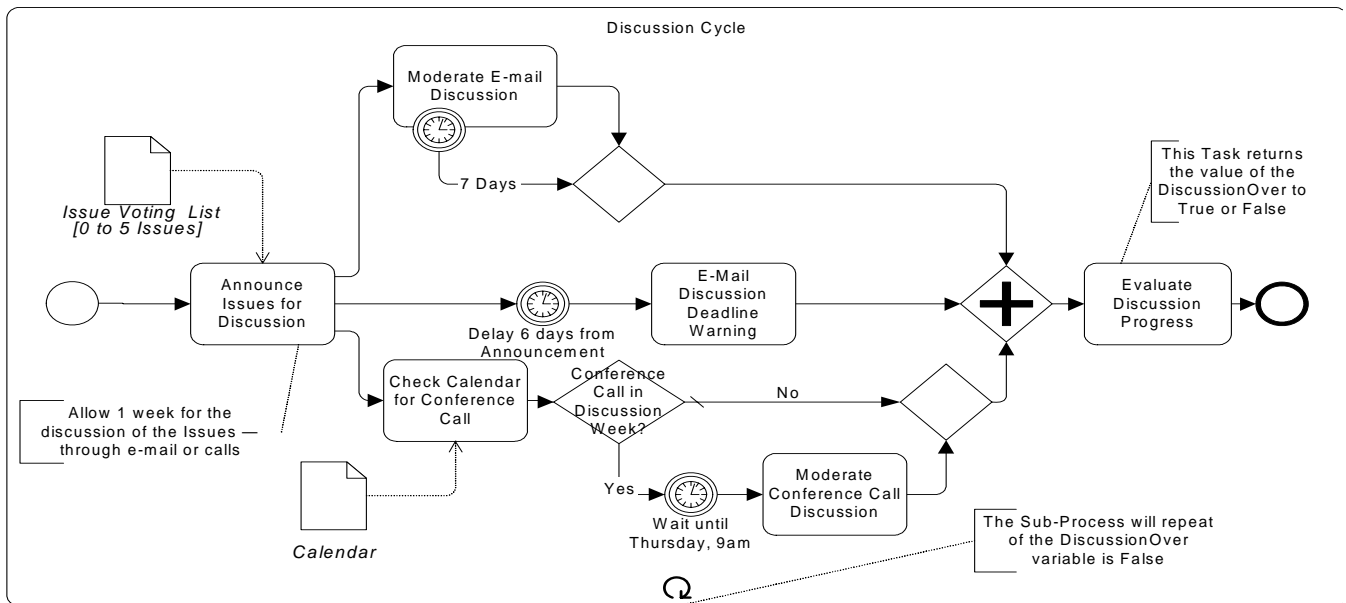

Figure 12.4 - “Discussion Cycle” Sub-Process Details

The Sub-Process starts of with a Task for the Issue List Manager to send an e-mail to the working group that a set of Issues are now open for discussion through the working group’s message board. Since this Task sends a message to an outside Participant (the working group members), an outgoing Message Flow is seen from the “Discussion Cycle” Sub-Process to the “Voting Members” Pool in Figure 12.1. Basically, the working group will be discussing the issues for one week and proposing additional solutions to the issues. After the first Task, three separate parallel paths are followed, which are synchronized downstream. This is shown by the three outgoing Sequence Flow for that activity.

The top parallel path in the figure starts with a long-running Task, “Moderate E-mail Discussion,” that has a Timer Intermediate Event attached to its boundary. Although the “Moderate E-Mail Discussion” Task will never actually be completed normally in this model, there must be an outgoing Sequence Flow for the Task since Start and End Events are being used within the Process. This Sequence Flow will merged with the Sequence Flow that comes from the Timer Intermediate Event. A merging Exclusive Gateway is used in this situation because the next object is a joining Parallel Gateway (the diamond with the cross in the center) that is used to synchronize the three parallel paths. If the merging Gateway was not used and both Sequence Flow connected to the joining Gateway, the Process would have been stuck at the joining Gateway that would wait for a Token to arrive from each of the incoming Sequence Flow.

The middle parallel path of the fork contains an Intermediate Event and a Task. A Timer Intermediate Event used in the middle of the Process flow (not attached to the boundary of an activity) will cause a delay. This delay is set to 6 days. The “E-Mail Discussion Deadline Warning” Task will follow. Again, since this Task sends a message to an outside Participant, an outgoing Message Flow is seen from the “Discussion Cycle” Sub-Process to the “Voting Members” Pool in Figure 12.1.

The bottom parallel path of the fork contains more than one object, first of which is Task where the issue list manager checks the calendar to see if there is a conference call this week. The output of the Task will be an update to the variable “ConCall,” which will be true or false. After the Task, an Exclusive Gateway with its two Gates follows. The Gate for labeled “default” Flow directly to an merging Exclusive Gateway, for the same reason as in the top parallel path. The Gate for the “Yes” Sequence Flow will have a *condition* that checks the value of the “ConCall” variable (set in the

previous Task) to see if there will be a conference call during the coming week. If so, the Timer Intermediate Event indicates delay, since all conference calls for the working group start at 9am PDT on Thursdays. The Task for moderating the conference call follows the delay, which is followed the merging Gateway.

The merging Gateways in the top and bottom paths and the “E-Mail Discussion Deadline Warning” Task all flow into a joining Gateway. This Gateway waits for all three paths to complete before the Process Flow to the next Task, “Evaluate Discussion Progress.” The issue list manager will review the status of the issues and the discussions during the past week and decide if the discussions are over. The DiscussionOver variable will be set to TRUE or FALSE, depending on this evaluation. If the variable is set to FALSE, then the whole Sub-Process will be repeated, since it has looping set and the loop condition will test the DiscussionOver variable.

12.2.1 Mapping to BPEL4WS

- The “Discussion Cycle” Sub-Process itself maps to a BPEL4WS *process*.
Because it is a Sub-Process within a higher-level Process (the “E-Mail Voting” Process), it is *invoked* from the higher-level Process. The *invoke* sends a message from one (higher-level) BPEL4WS *process* to the other (lower-level) *process* for instantiation.
- This means that the *process* being instantiated must have a *receive* to start it off.
- The *process* being instantiated must have a *reply* to end it, since it is being synchronously called.
The *receive* and *reply* are not actually shown in the BPMN Diagram, but it is derived from this *invoke* relationship of “Discussion Cycle” Process being a Sub-Process to the “E-Mail Voting” Process.
- Given this, the *activity* of the BPEL4WS *process* will be a *sequence* with the derived *receive* as the first *activity*.

The Diagrams elements of Figure 12.4 will determine the remaining activity(ies) of the sequence.

- The Sub-Process starts off with a Task, which maps to a BPEL4WS *invoke* (which is after the automatically generated *receive* that starts the *process*).
- After the first Task, three separate parallel paths are followed. The forking of the flow marks the start of a BPEL4WS *flow*. The *flow* will extend until the Parallel Gateway, which joins the three paths.

The Upper Parallel Path

In the upper parallel path of the fork, the Task, “Moderate E-mail Discussion,” has a Timer Intermediate Event attached to its boundary. Because of this,

- the Task is placed in its own *scope* with a *faultHandlers*.
- The Task itself is mapped to a BPEL4WS *invoke* (synchronous), and will be placed in a lower-level *flow*, for reasons described below.

The Timer Intermediate Event must be set up to create a *fault* at the appropriate time. To do this,

- An *eventHandlers* is added to the *scope*.
 - An *onAlarm* is included in the *eventHandlers* and the *for* attribute is set to the duration that is defined in the Timer Intermediate Event.
 - The *onAlarm* contains a *throw* with a fault name after the Intermediate Event with “_Exit” appended.

The *catch* of a *faultHandlers* will be triggered by the *fault* generated by the above *throw*. Since the Timer Intermediate Event leads direction to the Exclusive Gateway, there is no specific activity that must be performed in response to the time-out. The main purpose is to exit the Task. Thus,

- A *faultHandlers* is added to the *scope*.
 - The *catch* in the *faultHandlers* has a *faultName* set to Intermediate Event with “_Exit” appended.
 - the *catch* will contain an *empty* activity.

The Middle Parallel Path

The middle parallel path of the fork has a string of two objects.

- Even though this series of objects appears in the middle of a BPEL4WS *flow*, they will be placed within a *sequence* element.

In these situations, the *sequence* will continue until there is a location in the Diagram where there are multiple incoming Sequence Flow. When more than one Sequence Flow converge it marks the end of a BPEL4WS structure (as determined by structures that have been created by upstream objects). In this case, the Parallel Gateway also marks the end of the higher-level *flow*. The *sequence* will be listed in the higher-level *flow* without a *source* sub-element. This means that the *sequence* will be instantiated when the higher-level *flow* begins since it has no dependencies on any other *activity*. The *sequence* will have two activities:

- First, the Timer Intermediate Event used in this situation will map to a BPEL4WS *wait* (set to 6 days).
- Second, the “E-Mail Discussion Deadline Warning” Task will map to an *invoke* that follows the *wait*. In addition, this *invoke* can be asynchronous since a response is not required. This means that the *outputVariable* will not be included.

This middle path of the fork could have been configured in BPEL4WS without a *sequence* and with *links* instead. This is an example of a situation where a BPMN configuration may derive two possible BPEL4WS configurations. Since both BPEL4WS configurations will handle the appropriate behavior, it is up to the implementation of the BPMN to BPEL4WS derivation to determine which configuration will be used. BPMN does not provide any specific recommendation in these situations. However, the lower parallel path of the Process can also be modeled with a *sequence* or with *links*, and, to show how links would be used, this section of the Process will be mapped to elements in a *flow* that have dependencies specified by *links*.

The Lower Parallel Path

The lower parallel path of the fork has a number of objects and, as just described above, will be mapped to BPEL4WS elements connected with *links*. The path also contains a Decision, which can map to a *switch*, as will happen later in the process, but in this situation the Decision is mapped to *links* controlled by *transitionConditions*.

- The first object is a Task, which will map to an *invoke* (synchronous) that has two *source* elements referring to two of the *links*. There are two Target *links* because the Task is followed by the Gateway with its two Gates. This is done instead of a *switch* with a *case* and an *otherwise*.
 - The ConditionExpression for the Gate labeled “Yes” will map to the *source* element’s *transitionCondition*. The expression checks the value of the “ConCall” property (set in the previous Task) to see if there will be a conference call during the coming week.
 - The Gate labeled “No” has a condition of default. For a *switch*, this would map to the *otherwise* element. However, since a *switch* is not being used, the *source* element’s *transitionCondition* must be the inverse of all the other *transitionConditions* for the activity. The expression of the other *source* will be placed inside a “not” function.

The *invoke* will be listed in the higher-level *flow* without a *source* sub-element. This means that the *invoke* will be instantiated when the higher-level *flow* begins since it has no dependencies on any other *activity*. The remaining elements of the higher-level *flow* will have a *source* element. Thus, they will not be instantiated until the source of the *link* has completed.

- The “Yes” Gate from the Gateway leads to a Timer Intermediate Event, which will map to a *wait*.
 - The *for* element of the wait will set to for 9am PDT on the next Thursday.
 - This *wait* will have a *target* element that corresponds to the *target* element from the previous *invoke*.
 - The *wait* will also have a *target* element to link to the following *invoke*.
- The “No” Gate from the Gateway leads to a merging Exclusive Gateway, which means that nothing is expected to happen down this path. Thus, this will map to an *empty*.
 - This *empty* will have a *target* element that corresponds to the *target* element from the previous *invoke*.
- The Task for moderating the conference call follows the *wait*, which will map to an *invoke* (synchronous).
 - This *invoke* will have a *target* element that corresponds to the *target* element from the previous *wait*.

There are three link elements in the *flow*:

- One *link* will have a source of the first *invoke* and a target of the *wait*.
- One *link* will have a source of the first *invoke* and a target of the *empty*.
- One *link* will have a source of the first *wait* and a target of the last *invoke*.

As mentioned above, the Parallel Gateway marks the end of the *flow*.

Finally, there will be a *reply* at the end of the *sequence* that corresponds to the initial *receive* and lets the parent *process* know that the (sub) *process* has been completed.

After the Parallel Paths are Joined

The Task “Evaluate Discussion Progress” is intended to occur only when all the parallel paths have completed, and thus, it will

- Map to an *invoke* that follows the closing of the *flow*.

BPEL4WS Sample for the First Sub-Process

Example 12.2 displays some sample BPEL4WS code that reflects the portion of the Process as described above and shown in Figure 12.4.

```
<process name="Discussion_Cycle">
  <!-- The Process data is defined first-->
  <sequence>
    <receive partnerLink="Internal" portType="tns:processPort"
      operation="call_Discussion_Cycle" variable="processData" createInstance="Yes"/>
    <invoke name="AnnounceIssuesforDiscussion" partnerLink="WGVoter"
      portType="tns:emailPort" operation="sendDiscussionAnnouncement"
      inputVariable="processData"/>
  <flow>
    <links>
      <link name="CheckCalendarforConferenceCalltoWaituntilThursday,9am"/>
      <link name="CheckCalendarforConferenceCalltoEmpty"/>
      <link name="WaituntilThursday9amtoModerateConferenceCallDiscussion"/>
    </links>
    <!-- This is the first of the three paths of the fork. -->
    <scope>
      <invoke name="ModerateEmailDiscussion" partnerLink="internal"
        portType="tns:internalPort" operation="sendDiscussion"
        inputVariable="processData" outputVariable="processData"/>
      <faultHandlers>
        <catch faultName="7Days_Exit">
          <empty/>
        </catch>
      </faultHandlers>
      <eventHandlers>
        <onAlarm for="tns:OneWeek">
          <throw faultName="7Days_Exit"/>
        </catch>
      </eventHandlers>
    </scope>
    <!-- This is the second of the three paths of the fork. -->
```



```

<sequence>
  <wait name="Delay6daysfromDiscussionAnnouncement" for="P6D"/>
  <invoke name="EMailDiscussionDeadlineWarning" partnerLink="WGVoter"
    portType="tns:emailPort" operation="sendDiscussionWarning"
    inputVariable="processData">
  </invoke>
</sequence>
<!-- This is the third of the three paths of the fork. -->
<invoke name="CheckCalendarforConferenceCall" partnerLink="internal"
  portType="tns:internalPort" operation="receiveCallSchedule"
  inputVariable="processData" outputVariable="processData">
  <source linkName="CheckCalendarforConferenceCalltoWaituntilThursday9am"
    transitionCondition="bpws:getVariableProperty(processData,conCall)=true"/>
  <source linkName="CheckCalendarforConferenceCalltoEmpty"
    transitionCondition="not(bpws:getVariableProperty(processData,conCall)=true)"/>
</invoke>
<!-- name="Yes" -->
<wait name="WaituntilThursday9am" for="P6DT9H">
  <target linkName="CheckCalendarforConferenceCalltoWaituntilThursday9am">
  <source linkName="WaituntilThursday9amtoModerateConferenceCallDiscussion"/>
</wait>
<invoke name="ModerateConferenceCallDiscussion" partnerLink="internal"
  portType="tns:internalPort" operation="sendConCall"
  inputVariable="processData" outputVariable="processData">
  <target linkName="WaituntilThursday9amtoModerateConferenceCallDiscussion"/>
</invoke>
<!-- name="otherwise" -->
<empty>
  <target linkName="CheckCalendarforConferenceCalltoEmpty"/>
</empty>
</flow>
<invoke name="EvaluateDiscussionProgress" partnerLink="internal"
  portType="tns:internalPort" operation="receiveDiscussionStatus"
  inputVariable="processData" outputVariable="processData"/>
<reply partnerLink="Internal" portType="tns:processPort"
  operation="call_Discussion_Cycle" variable="processData"/>
</sequence>
</process>

```

Example 12.2 - BPEL4WS Sample of “Discussion Cycle” Sub-Process Details

12.3 The Second Sub-Process

Figure 12.5 shows the next section of the Process, which includes the expanded details of the “Collect Votes” Sub-Process.

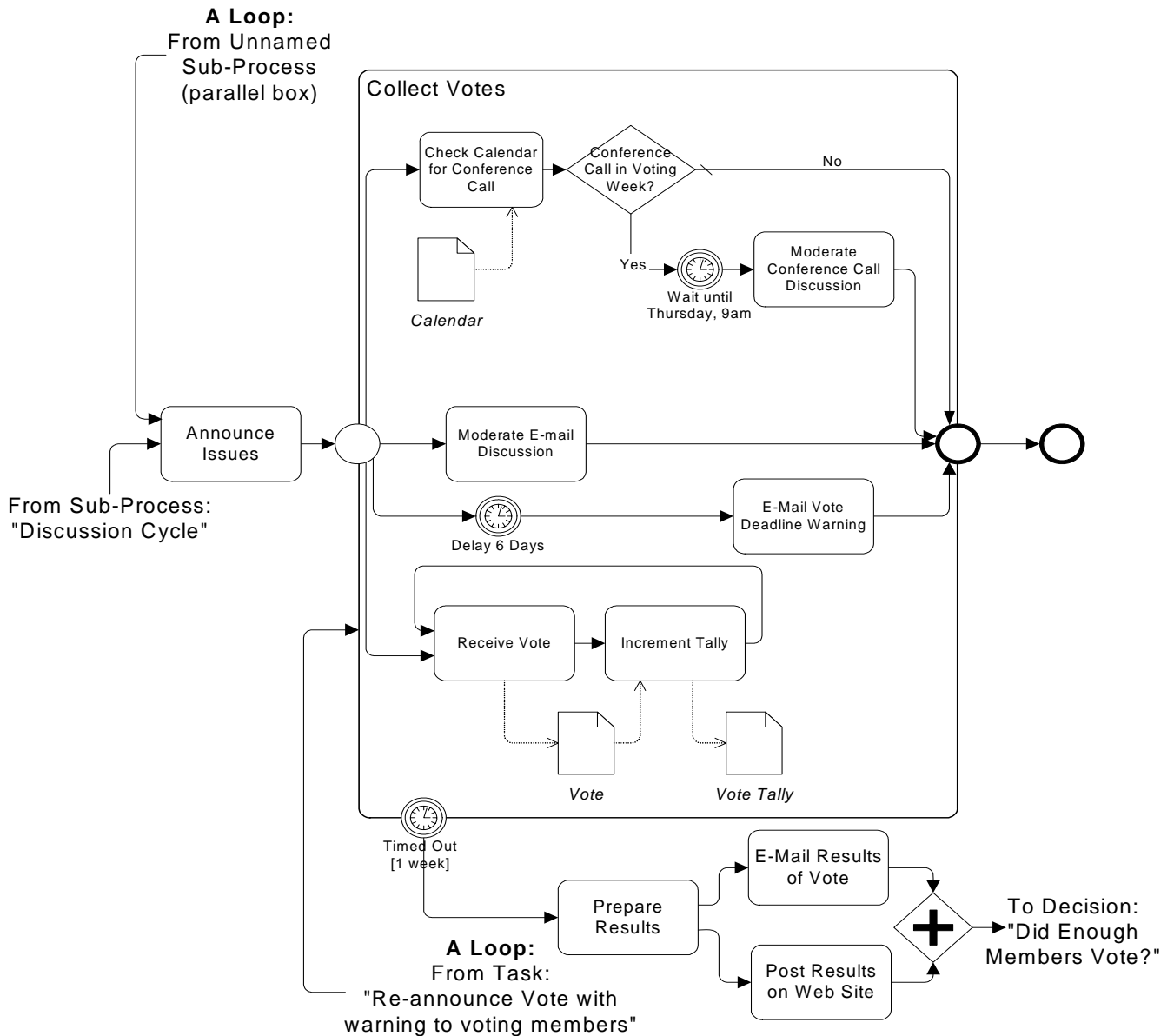

Figure 12.5 - “Collect Votes” Sub-Process Details

This part of the process starts out with a Task for the issue list manager to send out an e-mail to announce to the working group, and the voting members in particular, which lets them know that the issues are now ready for voting. Since this Task sends a message to an outside Participant (the working group members), an outgoing Message Flow is seen from the “Announce Issues” Task to the “Voting Members” Pool in Figure 12.1. This Task is also a target for one of the complex loops in the Process.

The “Collect Votes” Sub-Process follows the Task, and is also a target of one of the looping Sequence Flow. This Sub-Process is basically a set of four parallel paths that extend from the beginning to the end of the Sub-Process.

The first branch of the fork leads to a Decision that determines whether or not a conference call will occur during the upcoming week, after the Working Group's schedule has been checked. Basically, if there was a call last week, then there will not be a call this week and vice versa. The appropriate variable that was updated in the "Discussion Cycle" Process will be used again.

The second and third branches forks work the same way as the similar activities in the "Discussion Cycle" Sub-Process, except that the "Moderate E-Mail Discussion" Task does not have a Timer Intermediate Event attached. This is not necessary since the whole Sub-Process is interrupted after 7 days through the Intermediate Event attached to the Sub-Process boundary. The "E-Mail Vote Deadline Warning" Task sends a message to an outside Participant (the working group members), thus, an outgoing Message Flow is seen from the "Collect Votes" Sub-Process to the "Voting Members" Pool in Figure 12.1.

The fourth branch of the fork is rather unique in that the Diagram uses a loop that does not utilize a Decision. Thus, it is, as it is intended to be, an infinite loop. The policy of the working group is that voting members can vote more than once on an issue; that is, they can change their mind as many times as they want throughout the entire week. The first Task in the loop receives a message from the outside Participant (the working group members), thus, an incoming Message Flow is seen from the "Voting Members" Pool to the "Collect Votes" Sub-Process in Figure 12.1. The Timer Intermediate Event attached to the boundary of the Sub-Process is the mechanism that will end the infinite loop, since all work inside the Sub-Process will be ended when the time-out is triggered. All the remaining work of the Process is conducted after the time-out and Flow from the Timer Intermediate Event.

Figure 12.5 shows that there are Two Tasks that follow the time-out. First, a Task will prepare all the voting results, then a Task will send the results to the voting members. A Document Object, "Issue Votes," is shown in the Diagram to illustrate how one might be used, but it will not map to anything in the execution languages. The remaining activities of the Process will be described in the next section.

12.3.1 Mapping to BPEL4WS

The Loops Cause Derived Sub-Processes

- The first Task of this section of the Process is also a target for one of the complex loops in the Process, thus, it will map to an *invoke* (asynchronous) that is placed inside another derived *process* ("Announce_Issues_Derived_Process").
- This derived *process* will be *invoked* from "Discussion_Cycle_Derived_Process," after the "Discussion Cycle" process has been completed, as part of the Normal Flow and then from another part of the Process as part of the looping flow.
 - Thus, "Announce_Issues_Derived_Process" will require a (instantiation) *receive* to accept the message from "Discussion_Cycle_Derived_Process" and from "Issues_wo_Majority_Derived_Process" (as we shall see later).
- The "Collect Votes" Sub-Process follows the Task, but is also a target of one of the looping Sequence Flow. Thus, it will also be set inside a derived *process* ("Collect_Votes_Derived_Process").
 - In addition, "Collect_Votes_Derived_Process" will require a (instantiation) *receive* to accept the message from "Announce_Issues_Derived_Process" and from the fault handler of "Collect Votes" (as we shall see later).
- The "Collect Votes" Sub-Process will map to an *invoke* (asynchronous) and the details will be in a *process* referenced through the *invoke*.

The BPEL4WS Sample of the Derived Sub-Processes

Example 12.3 shows sample BPEL4WS code that defines the two derived *processes*.

```
<process name="Announce_Issues_Derived_Process">
  <!-- This starts the middle section of the Process and is call from
        the first time and then from "Collect Votes" during a loop-->
  <!-- The Process data is defined first-->
  <sequence>
    <receive partnerLink="Internal" portType="tns:processPort"
      operation="call_Announce_Issues_Derived_Process"
      variable="processData" createInstance="Yes"/>
    <invoke name="AnnounceIssuesforVote" partnerLink="WGVoter" portType="tns:emailPort"
      operation="sendVoteAnnouncement" inputVariable="processData"/>
    <invoke name="Collect_Votes_Derived_Process" partnerLink="Internal"
      portType="tns:processPort"
      operation="call_Collect_Votes_Derived_Process" inputVariable="processData"/>
    <reply partnerLink="Internal" portType="tns:processPort"
      operation="call_Announce_Issues_Derived_Process"
      variable="processData" createInstance="Yes"/>
  </sequence>
</process>

<process name="Collect_Votes_Derived_Process">
  <!-- this calls the second Sub-Process and then continues. It is also
        called from "Collect Votes" as part of a loop-->
  <!-- The Process data is defined first-->
  <sequence>
    <receive partnerLink="Internal" portType="tns:processPort"
      operation="call_Collect_Votes_Derived_Process" variable="processData"
      createInstance="Yes"/>
    <invoke name="Collect_Votes" partnerLink="Internal" portType="tns:processPort"
      operation="call_Collect_Votes" inputVariable="processData"/>
    <reply partnerLink="Internal" portType="tns:processPort"
      operation="call_Collect_Votes_Derived_Process" variable="processData"
      createInstance="Yes"/>
  </sequence>
</process>
```

Example 12.3 - BPEL4WS Sample that sets up the Access for the Second Sub-Process

The Paths of the Sub-Process

The “Collect Votes Sub-Process is basically a set of four parallel paths that extend from the beginning to the end of the Sub-Process.

- Thus, the *activity* for the *process* will be a *flow*.

The Upper Parallel Path

The first branch of this Sub-Process is basically the same as the upper parallel of the previous Sub-Process. An *invoke*, a *wait*, and an *empty* will be created. In addition, three *links* will be created to handle the dependencies between the elements, including the branching created by the Exclusive Gateway. See “The Lower Parallel Path” on page 214 for the details of the mappings.

The Middle Two Parallel Paths

The second and third branches of the fork are rather straightforward mappings of:

- Two Tasks to *invokes* (one synchronous and one asynchronous), and
- A Timer Intermediate Event to a *delay*.
- In addition, one *link* is created so that one of the *invokes* will wait for the *delay*.

The Lower Parallel Path

The fourth branch of the fork is the location the infinite loop.

- This loop will map to a BPEL4WS *while* with a *condition* of “1=0,” which will always be false.
- Inside the *while* is a *sequence* of two *invokes* (one synchronous and one asynchronous), which are mapped from the two Tasks in the loop.

Exiting the Second Sub-Process

To exit out of the infinite loop and the whole “Collect Votes” Sub-Process,

- A *scope* will be wrapped around the main *flow* of the *process*, which will include an *eventHandlers* and a *faultHandlers*.

The Timer Intermediate Event must be set up to create a *fault* at the appropriate time. To do this,

- An *onAlarm* will be placed inside the *eventHandlers*. The timing of the *onAlarm* will be determined by the time setting in the Intermediate Event.
 - Within the *onAlarm*, a *throw* will a fault name after the Intermediate Event with “_Exit” appended.
- The *catch* element of the *faultHandlers* will be triggered by the *fault* generated by the above *throw*.
 - The *activity* for the *catch* will be a *sequence* and will be the source of all the remaining activities of the Process, since all the remaining Sequence Flow begins from the Timer Intermediate Event.
 - The first three Tasks, as shown in the figure, will map to *invokes*. The latter two will be placed within a *flow*.

The Document Objects shown in the figure is not mapped into BPEL4WS. The remainder of the Process will be described in the next section.

BPEL4WS Sample for the Second Sub-Process

Example 12.4 shows sample BPEL4WS code that defines the “Collect Votes” Sub-Process.

```
<process name="Collect_Votes">
  <!--This is a nested process for the E-Mail Voting collection. It consists of
    an all and a faultHandlers (for a time-out). The all will never complete
    normally since there is an infinite loop inside. The timeout is intended to
    be the normal way of ending the process-->
  <sequence>
    <receive partnerLink="Internal" portType="tns:processPort"
      operation="call_Collect_Votes" variable="processData" createInstance="Yes"/>
    <scope>
      <flow>
        <links>
          <link name="Delay6daysfromVoteAnnouncementtoEMailVoteDeadlineWarning"/>
          <link name="CheckCalendarforConferenceCalltoWaituntilThursday9am"/>
          <link name="CheckCalendarforConferenceCalltoEmpty"/>
          <link name="WaituntilThursday9amtoModerateConferenceCallDiscussion"/>
        </links>
        <!--This is the first of the four paths of the fork. -->
        <invoke name="CheckCalendarforConferenceCall" partnerLink="internal"
          portType="tns:internalPort" operation="receiveCallSchedule"
          inputVariable="processData" outputVariable="processData">
          <source linkName="CheckCalendarforConferenceCalltoWaituntilThursday9am"
            transitionCondition="bpws:getVariableProperty(processData,conCall)=true"/>
          <source linkName="CheckCalendarforConferenceCalltoEmpty"
            transitionCondition="not(bpws:getVariableProperty(processData,conCall)=true)"/>
        </invoke>
        <!-- name="Yes" -->
        <wait name="WaituntilThursday9am" for="P6DT9H">
          <target linkName="CheckCalendarforConferenceCalltoWaituntilThursday9am">
            <source linkName="WaituntilThursday9amtoModerateConferenceCallDiscussion"/>
          </target>
        </wait>
        <invoke name="ModerateConferenceCallDiscussion" partnerLink="internal"
          portType="tns:internalPort" operation="sendConCall"
          inputVariable="processData" outputVariable="processData">
          <target linkName="WaituntilThursday9amtoModerateConferenceCallDiscussion"/>
        </invoke>
        <!-- name="otherwise" -->
        <empty>
          <target linkName="CheckCalendarforConferenceCalltoEmpty"/>
        </empty>
        <!-- This is the second of the four paths of the fork. -->
        <invoke name="ModerateEMailDiscussion" partnerLink="internal"
          portType="tns:internalPort" operation="sendDiscussion"
          inputVariable="processData" outputVariable="processData"/>
        <!--This is the third of the four paths of the fork.-->
        <wait name="Delay6daysfromVoteAnnouncement" for="P6D">
          <source linkName="Delay6daysfromVoteAnnouncementtoEMailVoteDeadlineWarning"/>
        </wait>
      </flow>
    </scope>
  </sequence>
</process>
```

```

<invoke name="EMailVoteDeadlineWarning" partnerLink="WGVoter"
    portType="tns:emailPort" operation="sendVoteWarning"
    inputVariable="processData">
    <target linkName="Delay6daysfromVoteAnnouncementtoEMailVote DeadlineWarning"/>
</invoke>
<!--This is the fourth of the four paths of the fork. This branch of the
    all is intended to be an infinite loop that is eventually
    interrupted by the Time Out. This is necessary since any voter can
    change their vote until the deadline. -->
<while condition="l=0">
    <sequence>
        <receive name="ReceiveVote" partnerLink="WGVoter" portType="tns:emailPort"
            operation="receiveVote" variable="processData"/>
        <invoke name="IncrementTally" partnerLink="internal"
            portType="tns:internalPort" operation="sendReceiveTotal"
            inputVariable="processData" outputVariable="processData"/>
    </sequence>
</while>
</flow>
<eventHandlers>
    <onAlarm for="P7D">
        <throw faultName="7days_Exit"/>
    </onAlarm>
</eventHandlers>
<faultHandlers>
    <catch faultName="7days_Exit">
        <!-- The BPMN Diagram shows that the Timer Intermediate Event connects directly
            to the rest of the Process. Thus, they will show up in this activity set. -->
        <sequence>
            <invoke name="PrepareResults" partnerLink="internal"
                portType="tns:internalPort" operation="sendReceiveResults"
                inputVariable="processData" outputVariable="processData"/>
            <flow>
                <invoke name="PostResultsonWebSite" partnerLink="internal"
                    portType="tns:internalPort" operation="postVotingResults"
                    inputVariable="processData"/>
                <invoke name="EMailResultsofVote" partnerLink="WGVoter"
                    portType="tns:emailPort" operation="sendVotingResults"
                    inputVariable="processData"/>
            </flow>

            <!--the rest of the process is not shown-->

        </sequence>
    </catch>
</faultHandlers>
</scope>
<reply partnerLink="Internal" portType="tns:processPort"
    operation="call_Collect_Votes" variable="processData" createInstance="Yes"/>
</sequence>
</process>

```

Example 12.4 - BPEL4WS Sample of the Second Sub-Process

12.4 The End of the Process

Figure 12.6 shows the last section of the Process, which includes a complex set of Decisions and loops.

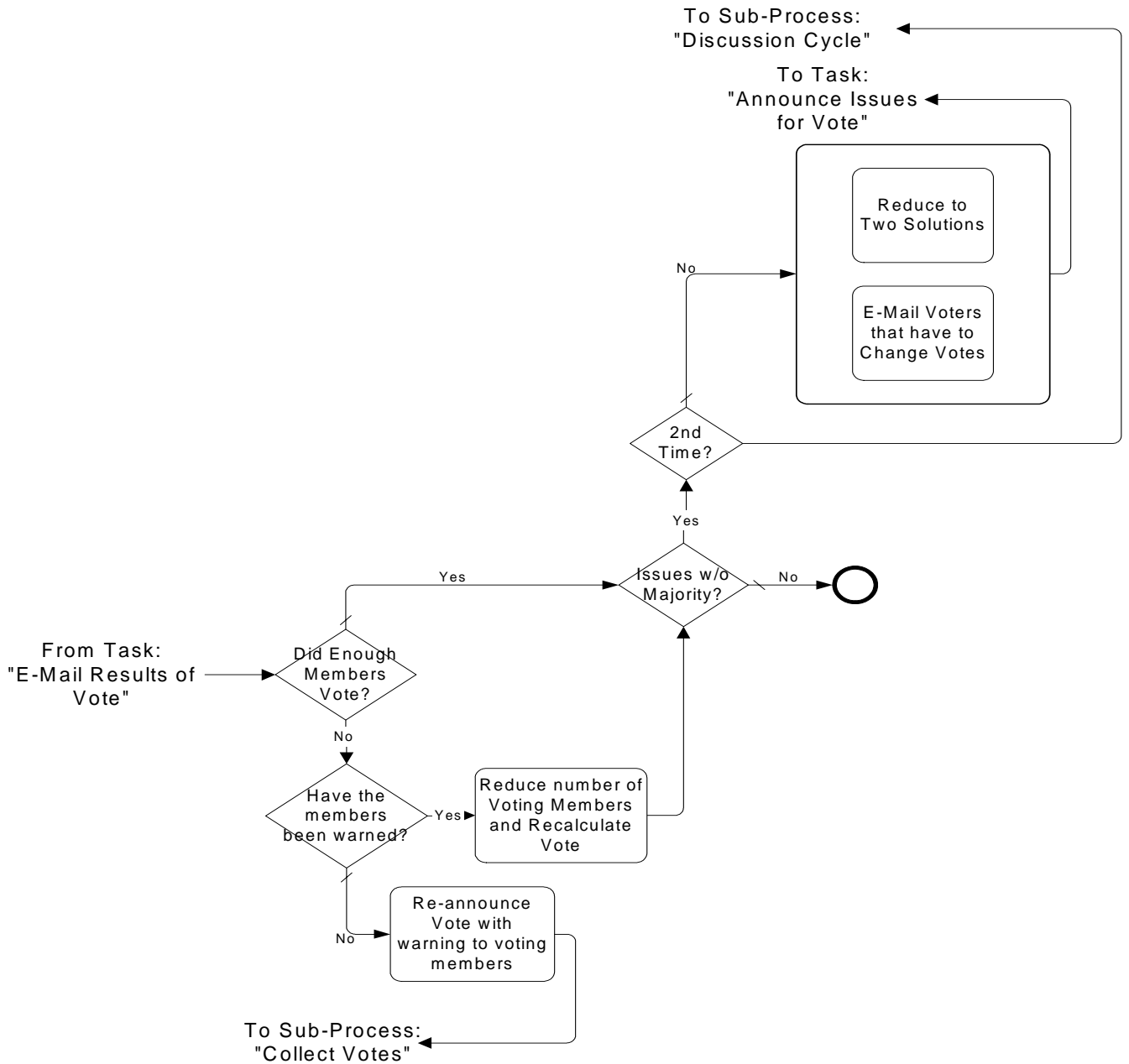

Figure 12.6 - The last segment of the E-Mail Voting Process

This segment of the Process continues from where the last segment left off (as described in the section above). It contains four Decisions that interact with each other and create loops to upstream activities.

The first Decision, “Did Enough Members Vote?,” is necessary since two-thirds of the voting members are required to approve any solution to an issue. If less than two-thirds of the voting members cast votes, which sometimes happens, the issues can’t be resolved. This Decision Flow to another Decision for both of its Alternatives. The “No” Alternative is followed by the “Have the Members been Warned?” Decision. If a voting member misses a vote, they are warned. If they miss a second vote, they lose their status as a voting member and the voting percentages are recalculate through a Task (“Reduce number of Voting Members and Recalculate Vote”). If they haven’t yet been warned, then a warning is sent and the voting week is repeated.

If all issues are resolved, then the Process is done. If not, then another Decision is required. The voting is given two chances before it goes back to another cycle of discussion. The first time will see a reduction of the number of solutions to the two most popular based on the vote (more if there are ties). Some voting members will have to change their votes just because their solution is no longer valid. These two activities are placed in a Sub-Process to show how a Sub-Process without Start and End Events can be used to create a simple set of parallel activities. Informally, this is called a “parallel box.” It is not a special object, but another use of Sub-Processes. For simple situations, it can be used to show a set of parallel activities without the extra clutter of a lot of Sequence Flow. In actuality, these two Tasks cannot actually be done in parallel, but they are modeled this way to highlight the optional use of Start and End Events.

After the parallel box, the flow loops back to the “Collect Votes” Sub-Process. If there already has been two cycles of voting, then the process Flow back to the “Decision Cycle” Sub-Process.

12.4.1 Mapping to BPEL4WS

As mentioned above, the entire contents of this segment follow a Timer Intermediate Event, which means they are contained in the *faultHandlers* of the *scope* within the “Collect Votes” *process*.

- Each of the Decisions in this section will map to a BPEL4WS *switch*.

The First Decision

The first Decision, “Did Enough Members Vote?,” Flow to another Decision for both of its Alternatives.

- Thus, each of the *switch cases* will contain another *switch*.

The “No” Alternative is followed by the “Have the Members been Warned?” Decision.

- Each Alternative from this Decision is followed by a Task, which maps to *Invokes* (one synchronous and the other asynchronous).

The “No (default)” Alternative leads to a loop.

- This looping is handled by using an *invoke* (asynchronous) to the “Collect_Votes_Derived_Process” *process*, which was created just for the purpose of this loop (since it is in the context of a more complex looping situation).

Notice that the “Issues w/o Majority?” Decision can be reached through the alternative paths from two different Decisions. This creates a situation that has two impacts on the Mapping to Execution Languages. First, it creates a section of the Process in which the Alternatives from two Decisions overlap. This is possible in a graph-structured Diagram like BPMN, but in a block-structured (and acyclic) language like BPEL4WS, these two sections cannot overlap because they have different block boundaries. This means that this section must be repeated in some way in both of the appropriate *switch case activities*. All these elements could be actually duplicated or they can be separated into a derived *process* and then *invoked* from the appropriate place. The later method was used in this example (see Example 12.5 and Example 12.6).

Note – At this point, BPMN does not specify whether a reused section of a BPMN Diagram should map to a derived *process* that is *invoked* from each location of duplication, or whether the section should remain intact and be duplicated in each appropriate location. This is left up to the specific implementation of BPMN since both solutions will behave equivalently.

The second impact of the multiple incoming Sequence Flow into the “Issues w/o Majority?” Decision has to do with how the three visible loops are created (actually there are five loops). Normally, Sequence Flow loops will map to a BPEL4WS *while*. If there are multiple loops in the Process they have to be physically separated or completely nested because of the block-structured nature of the BPEL4WS looping elements. The alternative paths of the Decisions cannot be mixed and still maintain the BPEL4WS blocks they way that the end of the “E-mail Voting” Process mixes the paths.

A different type of looping mechanism is required. This method requires the creation of a set of derived *processes* that can reference each other and also themselves. In this way, a block-structured language can simulate a set of interleaving loops (as seen in a graph-structured Diagram).

- Thus, in this BPMN example, derived *processes* were created to mark places where loops can be targeted within the BPEL4WS code from the “downstream” elements.
- A BPEL4WS *invoke* is used to re-perform activities that had already been executed in the process.

BPEL4WS Sample for the End of the Process

Example 12.5 displays the BPEL4WS code for first part of the end of the “E-Mail Voting Process.”

```
<!--This segment of the code is within the context of the "Collect
Votes" nested process-->
<catch property="tns:OneWeek" type="duration">
  <!--The BPMN Diagram shows that the Timer Intermediate Event connects directly to the
rest of the Process. Thus, they will show up in this activity set-->
  <!--The first two actions are not shown-->
  <sequence>
    <invoke name="PrepareResults" partnerLink="internal" portType="tns:internalPort"
      operation="sendReceiveResults" inputVariable="processData"
      outputVariable="processData"/>
    <invoke name="EMailResultsofVote" partnerLink="WGVoter" portType="tns:emailPort"
      operation="sendVotingResults" inputVariable="processData"/>
    <switch name="DidEnoughMembersVote">
      <!-- name="No" -->
      <case condition="bpws:getVariableProperty(ProcessData,NumVoted) >
        (.7) * (bpws:getVariableProperty(ProcessData,NumVWGM)) ">
```

```

<switch name="Havethemembersbeenwarned">
  <!-- name="Yes" -->
  <case condition="bpws:getVariableProperty(ProcessData,VotersWarned)=true">
    <sequence>
      <invoke name="ReducenumberofVotingMembersandRecalculateVote"
        partnerLink="internal" portType="tns:internalPort"
        operation="sendReceiveNumVoters" inputVariable="processData"
        outputVariable="processData"/>
      <!--Some elements of the process were separated into a derived
        process since they would have been repeated. They would have
        been repeated because they are arrived by alternative paths that
        do not close a set of alternative paths. -->
      <invoke name="Issues_wo_Majority_Derived_Process" partnerLink="Internal"
        portType="tns:processPort"
        operation="call_Issues_wo_Majority_Derived_Process"
        inputVariable="processData" outputVariable="processData"/>
    </sequence>
  </case>
  <!-- name="No (otherwise)" -->
  <otherwise>
    <sequence>
      <invoke name="ReannounceVotewithwarningtovotingmembers"
        partnerLink="WGVoter" portType="tns:emailPort"
        operation="sendReannounceVote" inputVariable="processData"
        outputVariable="processData"/>
      <invoke name="Collect_Votes_Derived_Process" partnerLink="Internal"
        portType="tns:processPort"
        operation="call_Collect_Votes_Derived_Process"
        inputVariable="processData" outputVariable="processData"/>
    </sequence>
  </otherwise>
</switch>
</case>
<!-- name="Yes (otherwise)" -->
<otherwise>
  <!-- Some elements of the process were separated into a derived process since they
    would have been repeated. They would have been repeated because they are
    arrived by alternative paths that do not close a set of alternative paths. -->
  <invoke process="Issues_wo_Majority_Derived_Process" partnerLink="Internal"
    portType="tns:processPort"
    operation="call_Issues_wo_Majority_Derived_Process"
    inputVariable="processData" outputVariable="processData"/>
</otherwise>
</switch>
</sequence>
</catch>

```

Example 12.5 - Sample BPEL4WS code for the last section of the Process

Example 12.6 shows the BPEL4WS code for the Process from the “Issues w/o Majority?” Decision until the end of the Process or loops.

- The mappings are a fairly straightforward set of *switches*.

If all issues are resolved, then the Process is done. If not, then another Decision is required.

- The “parallel box,” as is any forking situation, will map to a BPEL4WS *flow*.

After the parallel box, the flow loops back to the “Collect Votes” Sub-Process.

- This looping is handled by using an *invoke* (asynchronous) to the “Announce_Issues_Derived_Process” *process*, which was created just for the purpose of this loop.

If there has already been two cycles of voting, then the process Flow back to the “Decision Cycle” Sub-Process.

- This looping is handled by using an *invoke* (asynchronous) to the “Discussion_Cycle_Derived_Process” *process*, which was created just for the purpose of this loop.

Example 12.5 displays the BPEL4WS code for the final derived *process* of the “E-Mail Voting Process.”

```

<process name="Issues_wo_Majority_Derived_Process">
  <sequence>
    <receive partnerLink="Internal" portType="tns:processPort"
      operation="call_Issues_wo_Majority_Derived_Process" variable="processData"
      createInstance="Yes"/>
    <switch name="IssueswoMajority">
      <case name="Yes" condition="NoMajority=true">
        <switch name="2ndTime">
          <!-- name="Yes" -->
          <case condition="bpws:getVariableProperty(ProcessData,VotedOnce)=true">
            <!--This is done to do the complex looping situation. -->
            <invoke name="Discussion_Cycle_Derived_Process" partnerLink="Internal"
              portType="tns:processPort"
              operation="call_Discussion_Cycle_Derived_Process"
              inputVariable="processData" outputVariable="processData"/>
          </case>
          <!-- name="No (otherwise)"-->
        <otherwise>
          <sequence>
            <flow>
              <invoke name="ReducetoTwoSolutions" partnerLink="internal"
                portType="tns:internalPort" operation="sendReceiveSolutions"
                inputVariable="processData" outputVariable="processData"/>
              <invoke name="EMailVotersthathavetoChangeVotes" partnerLink="WGVoter"
                portType="tns:emailPort" operation="sendVoteWarning"
                inputVariable="processData"/>
            </flow>
          </sequence>
          <!-- This is one of the two ways to the end of the Process. -->
          <empty/>
        </otherwise>
      </switch>
      <otherwise name="Nootherwise">
        <!-- This is one of the two ways to the end of the Process. -->
        <empty/>
      </otherwise>
    </switch>
    <reply partnerLink="Internal" portType="tns:processPort"
      operation="call_Issues_wo_Majority_Derived_Process" variable="processData"
      createInstance="Yes"/>
  </sequence>
</process>

```

Example 12.6 - Sample BPEL4WS code for derived *process* for repeated elements

Annex A

(informative)

E-Mail Voting Process BPEL4WS

A.1 Introduction

This annex provides the complete BPEL4WS code for the example BPMN business process that is described in the “BPMN by Example” chapter.

```

<definitions
  targetNamespace="http://www.website.com"
  xmlns:xsd="http://www.w3.org/2001/XMLSchema">

  <message name="processDataMessage">
    <part name="NumIssues" type="xsd:integer"/>
    <part name="NoMajority" type="xsd:boolean"/>
    <part name="VotedOnce" type="xsd:boolean"/>
    <part name="NumVoted" type="xsd:integer"/>
    <part name="VotersWarned" type="xsd:boolean"/>
    <part name="LoopCounter" type="xsd:integer"/>
  </message>
  <!--processDataMessage will be received with the following parts:
    NoMajority (set to false)
    VotedOnce (set to false)
    NumVoted (set to false)
    VotersWarned (set to false)
    LoopCounter (set to 0)
    starting message every Friday is not shown here.-->
</definitions>

<!-- The Main Process -->
<process name="EMailVotingProcess">
  <variables>
    <variable name="processData" messageType="processDataMessage"/>
    <!--processDataMessage will be received with the following parts:
      NumIssues (set to the number of unresolved Issues)
      NoMajority (set to false)
      VotedOnce (set to false)
      NumVoted (set to false)
      VotersWarned (set to false)
      LoopCounter (set to 0)
      starting message every Friday is not shown here.-->
  </variables>
  <sequence>
    <!--This starts the beginning of the Process. The process that sends the
      starting message every Friday is not shown here.-->
    <receive partnerLink="Internal" portType="tns:processPort"
      operation="receiveIssueList" variable="processData" createInstance="Yes"/>
    <invoke name="ReviewIssueList" partnerLink="Internal" portType="tns:internalPort"
      operation="sendIssueList" inputVariable="processData"
      outputVariable="processData"/>
    <switch name="AnyIssuesReady">

```



```

<!--name="Yes" -->
<case condition="bpws:getVariableProperty(ProcessData,NumIssues)>0">
  <!-- A chunk of this process is separated into a derived process so that
  it can be called from a complex loop. -->
  <invoke name="Discussion_Cycle_Derived_Process" partnerLink="Internal"
    portType="tns:processPort" operation="call_Discussion_Cycle_Derived_Process"
    inputVariable="processData" outputVariable="processData"/>
</case>
<!--name="No" -->
<otherwise>
  <!--This is one of the two ways to the end of the Process.-->
  <empty/>
</otherwise>
</switch>
</sequence>

<!-- A Derived Process -->
<process name="Discussion_Cycle_Derived_Process">
  <variables>
    <variable name="processData" messageType="processDataMessage"/>
    <variable name="Discussion_Cycle_loopCounter" messageType="loopCounterMessage"/>
  </variables>
  <sequence>
    <receive partnerLink="Internal" portType="tns:processPort"
      operation="call_Discussion_Cycle_Derived_Process" variable="processData"
      createInstance="Yes"/>
    <!--The first Sub-Process has a loop condition, so it is within a while-->
    <assign name="Discussion_Cycle_initialize_loopCounter">
      <copy>
        <from expression="0"/>
        <to variable="Discussion_Cycle_loopCounter" part="loopCounter" />
      </copy>
    </assign>
    <!--Since the TestTime is "After" the Sub-Process has to be performed before the
    while-->
    <invoke name="Discussion_Cycle" partnerLink="Internal"
      portType="tns:processPort" operation="call_Discussion_Cycle"
      inputVariable="processData" outputVariable="processData"/>
    <while condition="bpws:getVariableProperty(ProcessData,DiscussionOver)=false">
      <!--This calls the first Sub-Process-->
      <sequence>
        <invoke process="Discussion_Cycle" partnerLink="Internal"
          portType="tns:processPort" operation="call_Discussion_Cycle"
          inputVariable="processData" outputVariable="processData"/>
        <assign>
          <copy>
            <from expression=
              "bpws:getVariableProperty(Discussion_Cycle_loopCounter,LoopCounter)+1"/>

```

```

        <to variable="Discussion_Cycle_loopCounter" part="LoopCounter"/>
    </copy>
</assign>
</sequence>
</while>
<!--This calls the first another derived process to handle the rest of the
work-->
<invoke name="Announce_Issues_Derived_Process" partnerLink="Internal"
        portType="tns:processPort" operation="call_Announce_Issues_Derived_Process"
        inputVariable="processData" outputVariable="processData"/>
</sequence>
</process>
</process>
<!-- A Derived Process -->
<process name="Announce_Issues_Derived_Process">
    <!-- This starts the middle section of the process. -->
    <variables>
        <variable name="processData" messageType="processDataMessage"/>
    </variables>
    <sequence>
        <receive partnerLink="Internal" portType="tns:processPort"
            operation="call_Announce_Issues_Derived_Process" variable="processData"
            createInstance="Yes"/>
        <invoke name="AnnounceIssuesforVote" partnerLink="WGVoter" portType="tns:emailPort"
            operation="sendVoteAnnouncement" inputVariable="processData"/>
        <invoke name="Collect_Votes_Derived_Process" partnerLink="Internal"
            portType="tns:processPort" operation="call_Collect_Votes_Derived_Process"
            inputVariable="processData" outputVariable="processData"/>
        <reply partnerLink="Internal" portType="tns:processPort"
            operation="call_Announce_Issues_Derived_Process"
            variable="processData" createInstance="Yes"/>
    </sequence>
</process>
<!-- A Derived Process -->
<process name="Collect_Votes_Derived_Process">
    <!--this calls the second Sub-Process. After the Collect Votes Sub-Process
        times out, the rest of the process will be in the fault handler
        of that process. Calls from there will loop back into other processes.-->
    <variables>
        <variable name="processData" messageType="processDataMessage"/>
    </variables>
    <sequence>
        <receive partnerLink="Internal" portType="tns:processPort"
            operation="call_Collect_Votes_Derived_Process" variable="processData"
            createInstance="Yes"/>
        <invoke name="Collect_Votes" partnerLink="Internal" portType="tns:processPort"
            operation="call_Collect_Votes" inputVariable="processData"
            outputVariable="processData"/>
    </sequence>
</process>

```

```

    <reply partnerLink="Internal" portType="tns:processPort"
        operation="call_Collect_Votes_Derived_Process" variable="processData"
        createInstance="Yes"/>
</sequence>
</process>
<!-- A Derived Process -->
<process name="Issues_wo_Majority_Derived_Process">
    <variables>
        <variable name="processData" messageType="processDataMessage"/>
    </variables>
    <sequence>
        <receive partnerLink="Internal" portType="tns:processPort"
            operation="call_Issues_wo_Majority_Derived_Process" variable="processData"
            createInstance="Yes"/>
        <switch name="IssueswoMajority">
            <case name="Yes"
                condition="bpws:getVariableProperty(ProcessData,NoMajority)=true">
                <switch name="2ndTime">
                    <!-- name="Yes" -->
                    <case condition="bpws:getVariableProperty(ProcessData,VotedOnce)=true">
                        <!--This is done to do the complex looping situation. -->
                        <invoke name="Discussion_Cycle_Derived_Process" partnerLink="Internal"
                            portType="tns:processPort"
                            operation="call_Discussion_Cycle_Derived_Process"
                            inputVariable="processData" outputVariable="processData"/>
                    </case>
                    <!-- name="No (otherwise)" -->
                    <otherwise>
                        <sequence>
                            <flow>
                                <invoke name="ReducetoTwoSolutions" partnerLink="internal"
                                    portType="tns:internalPort" operation="sendReceiveSolutions"
                                    inputVariable="processData" outputVariable="processData"/>
                                <invoke name="EMail Voters that have to Change Votes"
                                    partnerLink="WGVoter" portType="tns:emailPort"
                                    operation="sendVoteWarning" inputVariable="processData"/>
                            </flow>
                            <invoke process="Announce_Issues_Derived_Process" partnerLink="Internal"
                                portType="tns:processPort"
                                operation="call_Announce_Issues_Derived_Process"
                                inputVariable="processData" outputVariable="processData"/>
                        </sequence>
                    </otherwise>
                </switch>
            </case>
            <otherwise name="Nootherwise">
                <!-- This is one of the two ways to the end of the Process. -->
                <empty/>
            </otherwise>
        </switch>
    </sequence>
</process>

```

```

    </switch>
  </sequence>
</process>
<!-- A User Built Process -->
<process name="Discussion_Cycle">
  <!--This defines the first Sub-Process. -->
  <variables>
    <variable name="processData" messageType="processDataMessage"/>
  </variables>
  <sequence>
    <receive partnerLink="Internal" portType="tns:processPort"
      operation="call_Discussion_Cycle" variable="processData"
      createInstance="Yes"/>
    <invoke name="AnnounceIssuesforDiscussion" partnerLink="WGVoter"
      portType="tns:emailPort" operation="sendDiscussionAnnouncement"
      inputVariable="processData"/>
  <flow>
    <links>
      <link name="CheckCalendarforConferenceCalltoWaituntilThursday9am"/>
      <link name="CheckCalendarforConferenceCalltoEmpty"/>
      <link name="WaituntilThursday9amtoModerateConferenceCallDiscussion"/>
    </links>
    <!-- This is the first of the three paths of the fork. -->
    <scope>
      <invoke name="ModerateEmailDiscussion" partnerLink="internal"
        portType="tns:internalPort" operation="sendDiscussion"
        inputVariable="processData" outputVariable="processData"/>
      <faultHandlers>
        <catch faultName="7Days_Exit">
          <empty/>
        </catch>
      </faultHandlers>
      <eventHandlers>
        <onAlarm for="tns:OneWeek">
          <throw faultName="7Days_Exit"/>
        </catch>
      </eventHandlers>
    </scope>
    <!-- This is the second of the three paths of the fork. -->
    <sequence>
      <wait name="Delay6daysfromDiscussionAnnouncement" for="P6D"/>
      <invoke name="EMailDiscussionDeadlineWarning" partnerLink="WGVoter"
        portType="tns:emailPort" operation="sendDiscussionWarning"
        inputVariable="processData">
      </invoke>
    </sequence>
    <!-- This is the third of the three paths of the fork. -->
    <invoke name="CheckCalendarforConferenceCall" partnerLink="internal"
      portType="tns:internalPort" operation="receiveCallSchedule"

```

```

        inputVariable="processData" outputVariable="processData">
        <source linkName="CheckCalendarforConferenceCalltoWaituntilThursday9am"
            transitionCondition="bpws:getVariableProperty(processData,conCall)=true"/>
        <source linkName="CheckCalendarforConferenceCalltoEmpty"
            transitionCondition="not (bpws:getVariableProperty(processData,conCall)=true)"/>
    </invoke>
    <!-- name="Yes" -->
    <wait name="WaituntilThursday9am" for="P6DT9H">
        <target linkName=
            "CheckCalendarforConferenceCalltoWaituntilThursday9am">
        <source linkName="WaituntilThursday9amtoModerateConferenceCallDiscussion"/>
    </wait>
    <invoke name="ModerateConferenceCallDiscussion" partnerLink="internal"
        portType="tns:internalPort" operation="sendConCall"
        inputVariable="processData" outputVariable="processData">
        <target linkName="WaituntilThursday9amtoModerateConferenceCallDiscussion"/>
    </invoke>
    <!-- name="otherwise" -->
    <empty>
        <target linkName="CheckCalendarforConferenceCalltoEmpty"/>
    </empty>
</flow>
<invoke name="EvaluateDiscussionProgress" partnerLink="internal"
    portType="tns:internalPort" operation="receiveDiscussionStatus"
    inputVariable="processData" outputVariable="processData"/>
<reply partnerLink="Internal" portType="tns:processPort"
    operation="call_Discussion_Cycle" variable="processData"/>
</sequence>
</process>

<!-- A User Built Process -->
<process name="Collect_Votes">
    <!--This is a process for the E-Mail Voting collection. It consists of an all and a
        timeout event handler. The all will never complete normally since there is an
        infinite loop inside. The timeout is intended to be the normal way of ending the
        process. -->
    <variables>
        <variable name="processData" messageType="processDataMessage"/>
    </variables>
    <sequence>
        <receive partnerLink="Internal" portType="tns:processPort"
            operation="call_Collect_Votes" variable="processData" createInstance="Yes"/>
        <scope>
            <flow>
                <links>
                    <link name="Delay6daysfromVoteAnnouncementtoEMailVoteDeadlineWarning"/>
                    <link name="CheckCalendarforConferenceCalltoWaituntilThursday9am"/>
                    <link name="CheckCalendarforConferenceCalltoEmpty"/>
                    <link name="WaituntilThursday9amtoModerateConferenceCallDiscussion"/>
                </links>
            </flow>
        </scope>
    </sequence>
</process>

```

```

</links>
<!--This is the first of the four paths of the fork. -->
<invoke name="CheckCalendarforConferenceCall" partnerLink="internal"
    portType="tns:internalPort" operation="receiveCallSchedule"
    inputVariable="processData" outputVariable="processData">
    <target linkName="CheckCalendarforConferenceCalltoWaituntilThursday9am"
        transitionCondition="bpws:getVariableProperty(processData,conCall)=true"/>
    <target linkName="CheckCalendarforConferenceCalltoEmpty"
        transitionCondition="not (bpws:getVariableProperty(processData,conCall)=true)"/>
</invoke>
<!-- name="Yes" -->
<wait name="WaituntilThursday9am" for="P6DT9H">
    <source linkName=
        "CheckCalendarforConferenceCalltoWaituntilThursday9am">
    <target linkName="WaituntilThursday9amtoModerateConferenceCallDiscussion"/>
</wait>
<invoke name="ModerateConferenceCallDiscussion" partnerLink="internal"
    portType="tns:internalPort" operation="sendConCall"
    inputVariable="processData" outputVariable="processData">
    <source linkName="WaituntilThursday9amtoModerateConferenceCallDiscussion"/>
</invoke>
<!-- name="otherwise" -->
<empty>
    <source linkName="CheckCalendarforConferenceCalltoEmpty"/>
</empty>
<!-- This is the second of the four paths of the fork. -->
<invoke name="ModerateEMailDiscussion" partnerLink="internal"
    portType="tns:internalPort" operation="sendDiscussion"
    inputVariable="processData" outputVariable="processData"/>
<!--This is the third of the four paths of the fork.-->
<wait name="Delay6daysfromVoteAnnouncement" for="P6D">
    <target linkName="Delay6daysfromVoteAnnouncementtoEMailVoteDeadlineWarning"/>
</wait>
<invoke name="EMailVoteDeadlineWarning" partnerLink="WGVoter"
    portType="tns:emailPort" operation="sendVoteWarning"
    inputVariable="processData">
    <source linkName="Delay6daysfromVoteAnnouncementtoEMailVoteDeadlineWarning"/>
</invoke>
<!--This is the fourth of the four paths of the fork. This branch of the all is
    intended to be an infinite loop that is eventually interrupted by the Time
    Out. This is necessary since any voter can change their vote until the
    deadline. -->
<while condition="1=0">
    <sequence>
        <receive name="ReceiveVote" partnerLink="WGVoter" portType="tns:emailPort"
            operation="receiveVote" variable="processData"/>
        <invoke name="IncrementTally" partnerLink="internal"
            portType="tns:internalPort" operation="sendReceiveTotal"
            inputVariable="processData" outputVariable="processData"/>
    
```

```

        </sequence>
    </while>
</flow>
<eventHandlers>
    <onAlarm for="P7D">
        <throw faultName="7days_Exit"/>
    </onAlarm>
</eventHandlers>
<faultHandlers>
    <catch faultName="7days_Exit">
        <!-- The BPMN Diagram shows that the Timer Intermediate Event connects
            directly to the rest of the Process. Thus, they will show up in
            this activity set. -->
        <sequence>
            <invoke name="PrepareResults" partnerLink="internal"
                portType="tns:internalPort" operation="sendReceiveResults"
                inputVariable="processData" outputVariable="processData"/>
            <flow>
                <invoke name="PostResultsonWebSite" partnerLink="internal"
                    portType="tns:internalPort" operation="postVotingResults"
                    inputVariable="processData"/>
                <invoke name="EMailResultsofVote" partnerLink="WGVoter"
                    portType="tns:emailPort" operation="sendVotingResults"
                    inputVariable="processData"/>
            </flow>
            <switch name="DidEnoughMembersVote">
                <!-- name="No" -->
                <case condition="bpws:getVariableProperty(ProcessData,NumVoted)>
                    (.7)*(bpws:getVariableProperty(ProcessData,NumVWGM))">
                    <switch name="Havethemembersbeenwarned">
                        <!-- name="Yes" -->
                        <case condition="bpws:getVariableProperty(ProcessData,
                            VotersWarned)=true">
                            <sequence>
                                <invoke name="ReducenumberofVotingMembersandRecalculateVote"
                                    partnerLink="internal" portType="tns:internalPort"
                                    operation="sendReceiveNumVoters" inputVariable="processData"
                                    outputVariable="processData"/>
                                <!--Some elements of the process were separated into a derived process
                                    since they would have been repeated. They would have been
                                    repeated because they are arrived by alternativepaths that do not
                                    close a set of alternative paths. -->
                                <invoke name="Issues_wo_Majority_Derived_Process" partnerLink="Internal"
                                    PortType="tns:processPort"
                                    operation="call_Issues_wo_Majority_Derived_Process"
                                    inputVariable="processData" outputVariable="processData"/>
                            </sequence>
                        </case>
                        <!-- name="No (otherwise)" -->

```

```

    <otherwise>
      <sequence>
        <invoke name="ReannounceVotewithwarningtovotingmembers"
          partnerLink="WGVoter" portType="tns:emailPort"
          operation="sendReannounceVote" inputVariable="processData"
          outputVariable="processData"/>
        <invoke name="Collect_Votes_Derived_Process" partnerLink="Internal"
          portType="tns:processPort"
          operation="call_Collect_Votes_Derived_Process"
          inputVariable="processData" outputVariable="processData"/>
      </sequence>
    </otherwise>
  </switch>
</case>
<!-- name="Yes (otherwise)" -->
<otherwise>
  <!-- Some elements of the process were separated into a derived process
    since they would have been repeated. They would have been repeated
    because they are arrived by alternative that do not close a set of
    alternative paths. -->
  <invoke process="Issues_wo_Majority_Derived_Process" partnerLink="Internal"
    portType="tns:processPort"
    operation="call_Issues_wo_Majority_Derived_Process"
    inputVariable="processData" outputVariable="processData"/>
</otherwise>
</switch>
</sequence>
</catch>
</faultHandlers>
</scope>
<reply partnerLink="Internal" portType="tns:processPort"
  operation="call_Collect_Votes" variable="processData"/>
</sequence>
</process>

```

Annex B (informative)

BPMN Element Attributes and Types

This annex provides the complete set of BPMN Element Attributes and the definition of types that support the Attributes. All the tables in this annex also appear in Chapters 8, 9, and 10.

B.1 Business Process Diagram Attributes

The following table displays the set of attributes of a Business Process Diagram:

Table B.1 - Business Process Diagram Attributes

| Attributes | Description |
|--|--|
| Id : Object | This is a unique Id that distinguishes the Diagram from other Diagrams. |
| Name : String | Name is an attribute that is text description of the Diagram. |
| Version (0-1) : String | This defines the Version number of the Diagram. |
| Author (0-1) : String | This holds the name of the author of the Diagram. |
| Language (0-1) : String | This holds the name of the language in which text is written. The default is English. |
| ExpressionLanguage (0-1) : String | A Language MAY be provided so that the syntax of expressions used in the Diagram can be understood. |
| QueryLanguage (0-1) : String | A Language MAY be provided so that the syntax of queries used in the Diagram can be understood. |
| CreationDate (0-1) : Date | This defines the date on which the Diagram was create (for this Version). |
| ModificationDate (0-1) : Date | This defines the date on which the Diagram was last modified (for this Version). |
| Pools (1-n) : Pool | A BPD SHALL contain one or more Pools. The boundary of one of the Pools MAY be invisible (especially if there is only one Pool in the Diagram). Refer to “Pool” on page 75 for more information about Pools. |
| Documentation (0-1) : String | The modeler MAY add optional text documentation about the Diagram. |

B.2 Process Attributes

The following table displays the set of attributes of a Process:

Table B.2 - Process Attributes

| Attributes | Description |
|---|---|
| Id : Object | This is a unique Id that identifies the object from other objects within the Diagram. |
| Name : String | Name is an attribute that is text description of the object. |
| ProcessType (None Private Abstract Collaboration) None : String | ProcessType is an attribute that provides information about which lower-level language the Pool will be mapped. By default, the ProcessType is None (or undefined). A Private ProcessType MAY be mapped to an executable BPEL4WS <i>process</i> . An Abstract ProcessType is also called the public interface of a process (or other web services) and MAY be mapped to an abstract BPEL4WS <i>process</i> . A Collaboration ProcessType is also considered a “global” process and MAY be mapped to languages such as ebXML or WS Choreography. However, these mappings are not provided in this version of the specification. If the Process is to be used to create a BPEL4WS document, then the attribute MUST be set to Executable or Abstract. |
| Status (None Ready Active Cancelled Aborting Aborted Completing Completed) None : String | The Status of a Process is determined when the Process is being executed by a process engine. The Status of a Process can be used within Assignment Expressions. |
| GraphicalElements (0-n) : Object | The GraphicalElements attribute identifies all of the objects (e.g., Events, Activities, Gateways, and Artifacts) that are contained within the Process. |
| Assignments (0-n) : Assignment | One or more assignment expressions MAY be made for the object. The Assignment SHALL be performed as defined by the AssignTime attribute (see below). The details of Assignment is defined in “Assignment on page 268.” |
| Properties (0-n) : Property | Modeler-defined Properties MAY be added to a Process. These Properties are “local” to the Process. All Tasks, Sub-Process objects, and Sub-Processes that are embedded SHALL have access to these Properties. The fully delineated name of these properties is “<process name>.<property name>” (e.g., “Add Customer.Customer Name”). If a process is embedded within another Process, then the fully delineated name SHALL also be preceded by the Parent Process name for as many Parents there are until the top level Process. Further details about the definition of a Property can be found in “Property on page 270.” |
| AdHoc False : Boolean | AdHoc is a boolean attribute, which has a default of False. This specifies whether the Process is Ad Hoc or not. The activities within an Ad Hoc Process are not controlled or sequenced in a particular order, their performance is determined by the performers of the activities. If set to True, then the Ad Hoc marker SHALL be placed at the bottom center of the Process or the Sub-Process shape for Ad Hoc Processes. |

Table B.2 - Process Attributes

| Attributes | Description |
|---|---|
| [AdHoc = True only] AdHocOrdering (0-1) (Sequential Parallel) Parallel : String | If the Process is Ad Hoc (the AdHoc attribute is True), then the AdHocOrdering attribute MUST be included. This attribute defines if the activities within the Process can be performed in Parallel or must be performed sequentially. The default setting is Parallel and the setting of Sequential is a restriction on the performance that may be required due to shared resources. |
| [AdHoc = True only] AdHocCompletionCondition (0-1) : Expression | If the Process is Ad Hoc (the AdHoc attribute is True), then the AdHocCompletionCondition attribute MUST be included. This attribute defines the conditions when the Process will end. |
| SuppressJoinFailure False : Boolean | This attribute is included for mapping to BPEL4WS. This specifies whether or not a BPEL4WS joinFailure fault will be suppressed for all activities in the BPEL4WS process. |
| EnableInstanceCompensation False : Boolean | This attribute is included for mapping to BPEL4WS. It specifies whether or not a compensation can be performed after the Process has completed normally. |
| Categories (0-n) : String | The modeler MAY add one or more defined Categories that can be used for purposes such as reporting and analysis. |
| Documentation (0-1) : String | The modeler MAY add text documentation about the Process. |

B.3 Common Graphical Object Attributes

The following table displays a set of common attributes for BPMN graphical objects (Flow Objects, Swimlanes, Artifacts, and Connecting Objects).

Table B.3 - Common Graphical Object Attributes

| Attributes | Description |
|-------------------------------------|---|
| Id : Object | This is a unique Id that identifies the object from other objects within the Diagram. |
| Categories (0-n) : String | The modeler MAY add one or more defined Categories that can be used for purposes such as reporting and analysis. |
| Documentation (0-1) : String | The modeler MAY add text documentation about the object. |

B.4 Common Flow Object Attributes

The following table displays the set of attributes common to BPMN Flow Objects (Events, Activities, and Gateways), and which extends the set of common graphical object attributes (see Table B.3).

Table B.4 - Common Flow Object Attributes

| Attributes | Description |
|---------------------------------------|---|
| Name : String | Name is an attribute that is text description of the object. |
| Assignments (0-n) : Assignment | One or more assignment expressions MAY be made for the object. For activities, the Assignment SHALL be performed as defined by the AssignTime attribute. The Details of the Assignment is defined in “Assignment on page 268.” |
| Pool : Pool | A Pool MUST be identified for the object to identify its location. The attributes of a Pool can be found in “Pool on page 263.” |
| Lanes (0-n) : Lane | If the Pool has more than one Lane, then the Id of at least one Lane MUST be added. There MAY be multiple Lanes listed if the Lanes are organized in matrix or overlap in a non-nested manner, The attributes of a Lane can be found in “Lane on page 263.” |

B.5 Events

B.5.1 Common Event Attributes

The following table displays the set of attributes common to the three types of Events, and which extends the set of common Flow Object attributes (see Table B.4).

Table B.5 - Common Event Attributes

| Attributes | Description |
|--|--|
| EventType (Start End Intermediate) Start : String | The EventType MUST be of type Start, End, or Intermediate. |

B.5.2 Start Event

The following table displays the set of attributes of a Start Event, which extends the set of common Event elements (see Table B.5).

Table B.6 - Start Event Attributes

| Attributes | Description |
|--|--|
| Trigger (None Message Timer Rule Link Multiple) None : String | Trigger is an attribute (default None) that defines the type of trigger expected for that Start. The next six rows define the attributes that are required for each of the Trigger types. The Trigger list MAY be extended to include new types. These new Triggers MAY have a new modeler- or tool-defined Marker to fit within the boundaries of the Event. |
| [Message Trigger only] Message : Message | If the Trigger is a Message, then the a Message MUST be supplied. The attributes of a Message can be found in “Message on page 269.” |
| [Message Trigger only] Implementation (Web Service Other Unspecified) Web Service : String | This attribute specifies the technology that will be used to receive the message. A Web service is the default technology. |
| [Timer Trigger only] TimeDate (0-1) : Date | If the Trigger is a Timer, then a TimeDate MAY be entered. If a TimeDate is not entered, then a TimeCycle MUST be entered (see the attribute below). |
| [Timer Trigger only] TimeCycle (0-1) : String | If the Trigger is a Timer, then a TimeCycle MAY be entered. If a TimeCycle is not entered, then a TimeDate MUST be entered (see the attribute above). |
| [Rule Trigger only] RuleName : Rule | If the Trigger is a Rule, then a Rule MUST be entered. The attributes of a Rule can be found in “Rule on page 271.” |
| [Link Trigger only] LinkId : String | If the Trigger is a Link, then the LinkId MUST be entered. |
| [Link Trigger only] ProcessRef : Process | If the Trigger is a Link, then the ProcessRef MUST be entered. The identified Process MAY be the same Process as that of the Link Event. |
| [Multiple Trigger only] Triggers (2-n) : Trigger | If the Trigger attribute is a Multiple, then a list of two or more Triggers MUST be provided. Each Trigger MUST have the appropriate data (as defined above). The Trigger MUST NOT be of type None or Multiple. |

B.5.3 End Event

The following table displays the set of attributes of a End Event, which extends the set of common Event elements (see Table B.5).

Table B.7 - End Event Attributes

| Attributes | Description |
|--|---|
| Result (None Message Error Cancel Compensation Link Terminate Multiple) None : String | Result is an attribute (default None) that defines the type of result expected for that End. The Cancel Result MUST NOT be used unless the Event is used within a Process that is a Transaction. The Result list MAY be extended to include new types. These new Results MAY have a new modeler- or tool-defined Marker to fit within the boundaries of the Event. |
| [Message Result only] Message : Message | If the Result is a Message, then the Message MUST be supplied. The attributes of a Message can be found in “Message on page 269.” |
| [Message Trigger only] Implementation (Web Service Other Unspecified) Web Service : String | This attribute specifies the technology that will be used to send the message. A Web service is the default technology. |
| [Error Result only] ErrorCode : String | If the Result is an Error, then the ErrorCode MUST be supplied. |
| [Compensation Result only] Activity : Object | If the Result is a Compensation, then the Object of the Activity that needs to be compensated MUST be supplied. |
| [Link Result only] LinkId : String | If the Result is a Link, then the LinkId MUST be entered. |
| [Link Result only] ProcessRef : Process | If the Result is a Link, then the ProcessRef MUST be entered. The identified Process MAY be the same Process as that of the Link Event. |
| [Multiple Result only] Results (2-n) : Result | If the Result attributes is a Multiple, then a list of two or more Results MUST be entered. Each Result on the list MUST have the appropriate data as specified for the above attributes. The Result MUST NOT be of type None, Terminate, or Multiple. |

B.5.4 Intermediate Event

The following table displays the set of attributes of an Intermediate Event, which extends the set of common Event elements (see Table B.5).

Table B.8 - Intermediate Event Attributes

| Attributes | Description |
|--|---|
| Trigger (None Message Timer Error Cancel Link Compensation Rule Multiple) Message : String | Trigger is an attribute (default Message) that defines the type of trigger expected for that Intermediate Event. The None and Link Trigger MUST NOT be used when the Event is attached to the boundary of an Activity. The Multiple, Rule, and Cancel Triggers MUST NOT be used when the Event is part of the Normal Flow of the Process. The Cancel Trigger MUST NOT be used when the Event is attached to the boundary of an Activity that is not a Transaction or if the Event is not contained within a Process that is a Transaction. The Trigger list MAY be extended to include new types. These new Triggers MAY have a new modeler- or tool-defined Marker to fit within the boundaries of the Event. |
| Target (0-1) : Object | A Target MAY be included for the Intermediate Event. The Target MUST be an activity (Sub-Process or Task). This means that the Intermediate Event is attached to the boundary of the activity and is used to signify an exception or compensation for that activity. |
| [Message Trigger only] Message : Message | If the Trigger is a Message, then the Message MUST be supplied. The attributes of a Message can be found in “Message on page 269.” |
| [Message Trigger only] Implementation (Web Service Other Unspecified) Web Service : String | This attribute specifies the technology that will be used to send or receive the message. A Web service is the default technology. |
| [Timer Trigger only] TimeDate (0-1) : Date | <ul style="list-style-type: none"> • If the Trigger is a Timer, then a TimeDate MAY be entered. • If a TimeDate is not entered, then a TimeCycle MUST be entered (see the attribute below). |
| [Timer Trigger only] TimeCycle (0-1) : String | <ul style="list-style-type: none"> • If the Trigger is a Timer, then a TimeCycle MAY be entered. • If a TimeCycle is not entered, then a TimeDate MUST be entered (see the attribute above). |

Table B.8 - Intermediate Event Attributes

| Attributes | Description |
|--|--|
| [Error Trigger only] ErrorCode : String | For an Intermediate Event within Normal Flow: <ul style="list-style-type: none"> • If the Trigger is an Error, then the error code MUST be entered. This “throws” the error. For an Intermediate Event attached to the boundary of an Activity: <ul style="list-style-type: none"> • If the Trigger is an Error, then the error code MAY be entered. This “catches” the error. • If there is no error code, then any Error SHALL trigger the Event. • If there is an error code, then only an Error that matches the error code SHALL trigger the Event. |
| [Compensation Trigger only] Activity : Object | For an Intermediate Event within Normal Flow: <ul style="list-style-type: none"> • If the Trigger is a Compensation, then the Object of the Activity that needs to be compensated MUST be supplied. This “throws” the compensation. For an Intermediate Event attached to the boundary of an Activity: This Event “catches” the compensation. No further information is required. The Object of the activity the Event is attached to will provide the Id necessary to match the compensation event with the event that “threw” the compensation. |
| [Rule Trigger only] RuleName : Rule | If the Trigger is a Rule, then a Rule MUST be entered. The attributes of a Rule can be found in “Rule on page 271.” |
| [Link Trigger only] LinkId : String | If the Trigger is a Link, then the LinkId MUST be supplied. |
| [Link Trigger only] ProcessRef : Process | If the Trigger is a Link, then the ProcessRef MUST be entered. The identified Process MAY be the same Process as that of the Link Event. |
| [Multiple Trigger only] Triggers (2-n) : Trigger | If the Trigger attribute is a Multiple, then each Trigger on the list MUST have the appropriate data as specified for the above attributes. The Trigger MUST NOT be of type None or Multiple. |

B.6 Activities

B.6.1 Common Activity Attributes

The following table displays the set of attributes common to both a Sub-Process and a Task, and which extends the set of common Flow Object attributes (see Table B.4) -- Note that Figure 10.57 and Figure 10.58 contain additional attributes that must be included within this set if extended by any other attribute table.

Table B.9 - Common Activity Attributes

| Attributes | Description |
|---|---|
| ActivityType (Task Sub-Process) Task : String | The ActivityType MUST be of type Task or Sub-Process. |
| Status (None Ready Active Cancelled Aborting Aborted Completing Completed) None : String | The Status of an activity is determined when the activity is being executed by a process engine. The Status of an activity can be used within Assignment Expressions. |
| Properties (0-n) : Property | Modeler-defined Properties MAY be added to an activity. These Properties are “local” to the activity object. These Properties are only for use within the processing of the activity. The fully delineated name of these properties are “<process name>.<sub-process name>.<property name>” (e.g., “Add Customer.Review Credit.Status”). Further details about the definition of a Property can be found in “Property on page 270.” |
| InputSets (0-n) : Input | The InputSets attribute defines the data requirements for input to the activity. Zero or more InputSets MAY be defined. Each Input set is sufficient to allow the activity to be performed (if it has first been instantiated by the appropriate signal arriving from an incoming Sequence Flow). |
| [Input: for InputSets only] Inputs (1-n) : Artifact | One or More Inputs MUST be defined for each InputSet. An Input is an Artifact, usually a Document Object. Note that the Artifacts MAY also be displayed on the diagram and MAY be connected to the activity through an Association--however, it is not required for them to be displayed. |
| OutputSets (0-n) : Output | The OutputSets attribute defines the data requirements for output from the activity. Zero or more OutputSets MAY be defined. At the completion of the activity, only one of the OutputSets may be produced--It is up to the implementation of the activity to determine which set will be produced. However, the IORules attribute MAY indicate a relationship between an OutputSet and an InputSet that started the activity. |
| [Output: for OutputSets only] Outputs (1-n) : Artifact | One or more Outputs MUST be defined for each OutputSet. An Output is an Artifact, usually a Document Object. Note that the Artifacts MAY also be displayed on the diagram and MAY be connected to the activity through an Association--however, it is not required for them to be displayed. |

Table B.9 - Common Activity Attributes

| Attributes | Description |
|---|---|
| IORules (0-n) : Expression | The IORules attribute is an expression that defines the relationship between one InputSet and one OutputSet. That is, if the activity is instantiated with a specified InputSet, then the output of the activity MUST produce the specified OutputSet. Zero or more IORules may be entered. |
| StartQuantity 1 : Integer | The default value is 1. The value MUST NOT be less than 1. This attribute defines the number of Tokens that must arrive from a single Sequence Flow before the activity can begin. |
| LoopType (None Standard MultiInstance) None : String | LoopType is an attribute and is by default None, but MAY be set to Standard or MultiInstance. If so, the Loop marker SHALL be placed at the bottom center of the activity shape (see Figure 9.5 and Figure 9.13). A Task of type Receive that has its Instantiate attribute set to True MUST NOT have a Standard or MultiInstance LoopType. |

Standard Loop Attributes

The following are additional attributes of a Standard Loop Activity (where the LoopType attribute is set to “Standard”), which extends the set of common activity attributes (see Table B.9).

Table B.10 - Standard Loop Activity Attributes

| Attributes | Description |
|---|---|
| LoopCondition : Expression | Standard Loops MUST have a boolean Expression to be evaluated, plus the timing when the expression SHALL be evaluated. The attributes of an Expression can be found in “Expression on page 269.” |
| LoopCounter : Integer | The LoopCounter attribute is used at runtime to count the number of loops and is automatically updated by the process engine. The LoopCounter attribute MUST be incremented at the start of a loop. The modeler may use the attribute in the LoopCondition Expression. |
| LoopMaximum (0-1) : Integer | The Maximum an optional attribute that provides is a simple way to add a cap to the number of loops. This SHALL be added to the Expression defined in the LoopCondition. |
| TestTime (Before After) After : String | The expressions that are evaluated Before the activity begins are equivalent to a programming while function. The expression that are evaluated After the activity finishes are equivalent to a programming until function. |

Multi-Instance Loop Attributes

The following are additional attributes of a Multi-Instance Loop Activity (where the LoopType attribute is set to “MultiInstance”), which extends the set of common activity attributes (see Table B.9).

Table B.11 - Multi-Instance Loop Activity Attributes

| Attributes | Description |
|--|--|
| MI_Condition : Expression | MultiInstance Loops MUST have a numeric Expression to be evaluated--the Expression MUST resolve to an integer. The attributes of an Expression can be found in “Expression on page 269.” |
| LoopCounter : Integer | The LoopCounter attribute is only applied for Sequential MultiInstance Loops and for processes that are being executed by a process engine. The attribute is updated at runtime by a process engine to count the number of loops as they occur. The LoopCounter attribute MUST be incremented at the start of a loop. Unlike a Standard loop, the modeler does not use this attribute in the MI_Condition Expression, but it can be used for tracking the status of a loop. |
| MI_Ordering (Sequential Parallel) Sequential : String | This applies to only MultiInstance Loops. The MI_Ordering attribute defines whether the loop instances will be performed sequentially or in parallel. Sequential MI_Ordering is a more traditional loop. Parallel MI_Ordering is equivalent to multi-instance specifications that other notations, such as UML Activity Diagrams use. If set to Parallel, the Parallel marker SHALL replace the Loop Marker at the bottom center of the activity shape (see Figure 9.8 and Figure 9.13). |
| [Parallel MI_Ordering only] MI_FlowCondition (None One All Complex) All : String | <p>This attribute is equivalent to using a Gateway to control the flow past a set of parallel paths.</p> <ul style="list-style-type: none"> • An MI_FlowCondition of “None” is the same as uncontrolled flow (no Gateway) and means that all activity instances SHALL generate a token that will continue when that instance is completed. • An MI_FlowCondition of “One” is the same as an Exclusive Gateway and means that the Token SHALL continue past the activity after only one of the activity instances has completed. The activity will continue its other instances, but additional Tokens MUST NOT be passed from the activity. • An MI_FlowCondition of “All” is the same as a Parallel Gateway and means that the Token SHALL continue past the activity after all of the activity instances have completed. • An MI_FlowCondition of “Complex” is the same as a Complex Gateway. The ComplexMI_FlowCondition attribute will determine the Token flow. |
| [Complex MI_FlowCondition only] ComplexMI_FlowCondition (0-1) : Expression | If the MI_FlowCondition attribute is set to “Complex,” then an Expression Must be entered. This Expression that MAY reference Process data. The expression SHALL determine when and how many Tokens will continue past the activity. The attributes of an Expression can be found in “Expression on page 269.” |

B.6.2 Sub-Process

The following table displays the set of attributes of a Sub-Process, which extends the set of common activity attributes (see Table B.9).

Table B.12 - Sub-Process Attributes

| Attributes | Description |
|---|--|
| SubProcessType (Embedded Independent Reference) Embedded : String | SubProcessType is an attribute that defines whether the Sub-Process details are embedded within the higher level Process or refers to another, re-usable Process. The default is Embedded. |
| IsATransaction False : Boolean | IsATransaction determines whether or not the behavior of the Sub-Process will follow the behavior of a Transaction (see “Sub-Process Behavior as a Transaction on page 59.”) |
| Transaction (0-1) : Transaction | If the Transaction attribute is False, then a Transaction MUST NOT be identified. If the Transaction attribute is True, then a Transaction MUST be identified. The attributes of a Transaction can be found in “Transaction on page 271” Note that Transactions that are in different Pools and are connected through Message Flow MUST have the same TransactionId. |

Embedded Sub-Process

The following are additional attributes of a Embedded Sub-Process (where the SubProcessType attribute is set to “Embedded”), which extends the set of Sub-Process attributes (see Table B.12).

Table B.13 - Embedded Sub-Process Attributes

| Attributes | Description |
|---|--|
| GraphicalElements (0-n) : Object | The GraphicalElements attribute identifies all of the objects (e.g., Events, Activities, Gateways, and Artifacts) that are contained within the Embedded Sub-Process. |
| AdHoc False : Boolean | AdHoc is a boolean attribute, which has a default of False. This specifies whether the Embedded Sub-Process is Ad Hoc or not. The activities within an Ad Hoc Embedded Sub-Process are not controlled or sequenced in a particular order, there performance is determined by the performers of the activities. |
| [AdHoc = True only] AdHocOrdering (0-1) (Sequential Parallel) Parallel : String | If the Embedded Sub-Process is Ad Hoc (the AdHoc attribute is True), then the AdHocOrdering attribute MUST be included. This attribute defines if the activities within the Process can be performed in Parallel or must be performed sequentially. The default setting is Parallel and the setting of Sequential is a restriction on the performance that may be required due to shared resources. |
| [AdHoc = True only] AdHocCompletionCondition (0-1) : Expression | If the Embedded Sub-Process is Ad Hoc (the AdHoc attribute is True), then a Completion Condition MUST be included, which defines the conditions when the Process will end. The Ad Hoc marker SHALL be placed at the bottom center of the Process or the Sub-Process shape for Ad Hoc Processes. |

Independent Sub-Process Attributes

The following are additional attributes of a Independent Sub-Process (where the SubProcessType attribute is set to “Independent”), which extends the set of Sub-Process attributes (see Table B.12).

Table B.14 - Independent Sub-Process Attributes

| Attributes | Description |
|--|--|
| DiagramRef : Business Process Diagram | The BPD MUST be identified. The attributes of a BPD can be found in “Business Process Diagram Attributes on page 28.” |
| ProcessRef : Process | A Process MUST be identified. The attributes of a Process can be found in “Processes on page 29” |
| InputPropertyMaps (0-n) : Expression | Multiple input mappings MAY be made between properties of the Independent Sub-Process and the properties of the Process referenced by this object. These mappings are in the form of an expression (although a modeling tool can present this to a modeler in any number of ways). |
| OutputPropertyMaps (0-n) : Expression | Multiple output mappings MAY be made between properties of the Independent Sub-Process and the properties of the Process referenced by this object. These mappings are in the form of an expression (although a modeling tool can present this to a modeler in any number of ways). |

Reference Sub-Process Attributes

The following table displays the set of attributes of a Reference Sub-Process (where the SubProcessType attribute is set to “Reference”), which extends the set of Sub-Process attributes (see Table B.12).

Table B.15 - Reference Sub-Process Attributes

| Attributes | Description |
|-----------------------------|---|
| SubProcessRef : Task | The Sub-Process being referenced MUST be identified. The attributes for the Sub-Process element can be found in Figure . |

B.6.3 Task

The following table displays the set of attributes of a Task, which extends the set of common activity object attributes (see Table B.9).

Table B.16 - Task Attributes

| Attributes | Description |
|--|--|
| TaskType (Service Receive Send User Script Abstract Manual Reference None) None : String | TaskType is an attribute that has a default of Service, but MAY be set to Send, Receive, User, Script, Abstract, Manual, Reference, or None. The TaskType will be impacted by the Message Flow to and/or from the Task, if Message Flow are used. A TaskType of Receive MUST NOT have an outgoing Message Flow. A TaskType of Send MUST NOT have an incoming Message Flow. A TaskType of Script, Manual, or None MUST NOT have an incoming or an outgoing Message Flow. The TaskType list MAY be extended to include new types. The attributes for specific settings of TaskType can be found in Figure through Figure . |

Service Task Attributes

The following table displays the set of attributes of a Service Task (where the TaskType attribute is set to “Service”), which extends the set of Task attributes (see Table B.16).

Table B.17 - Service Task Attributes

| Attributes | Description |
|---|---|
| InMessage : Message | A Message for the InMessage attribute MUST be entered. This indicates that the Message will be sent at the start of the Task, after the availability of any defined InputSets. A corresponding outgoing Message Flow MAY be shown on the diagram. However, the display of the Message Flow is not required. |
| OutMessage : Message | A Message for the OutMessage attribute MUST be entered. The arrival of this message marks the completion of the Task, which may cause the production of an OutputSet. A corresponding incoming Message Flow MAY be shown on the diagram. However, the display of the Message Flow is not required. |
| Implementation (Web Service Other Unspecified) Web Service : String | This attribute specifies the technology that will be used to send and receive the messages. A Web service is the default technology. |

Receive Task Attributes

The following table displays the set of attributes of a Receive Task (where the TaskType attribute is set to “Receive”), which extends the set of Task attributes (see Table B.16).

Table B.18 - Receive Task Attributes

| Attributes | Description |
|--|---|
| Message : Message | A Message for the Message attribute MUST be entered. This indicates that the Message will be received by the Task. The Message in this context is equivalent to an <i>in-only</i> message pattern (Web service). A corresponding incoming Message Flow MAY be shown on the diagram. However, the display of the Message Flow is not required. |
| Instantiate False : Boolean | Receive Tasks can be defined as the instantiation mechanism for the Process with the Instantiate attribute. This attribute MAY be set to true if the Task is the first activity after the Start Event or a starting Task if there is no Start Event. Multiple Tasks MAY have this attribute set to True. |
| Implementation (Web Service Other Unspecified) Web Service : String | This attribute specifies the technology that will be used to receive the message. A Web service is the default technology. |

Send Task Attributes

The following table displays the set of attributes of a Send Task (where the TaskType attribute is set to “Send”), which extends the set of Task attributes (see Table B.16).

Table B.19 - Send Task Attributes

| Attributes | Description |
|--|--|
| Message : Message | A Message for the Message attribute MUST be entered. This indicates that the Message will be sent by the Task. The Message in this context is equivalent to an <i>out-only</i> message pattern (Web service). A corresponding outgoing Message Flow MAY be shown on the diagram. However, the display of the Message Flow is not required. |
| Implementation (Web Service Other Unspecified) Web Service : String | This attribute specifies the technology that will be used to send the message. A Web service is the default technology. |

User Task Attributes

The following table displays the set of attributes of a User Task (where the TaskType attribute is set to “User”), which extends the set of Task attributes (see Table B.16).

Table B.20 - User Task Attributes

| Attributes | Description |
|--|---|
| Performers (1-n) : String | One or more Performers MAY be entered. The Performers attribute defines the human resource that will be performing the Task. The Performers entry could be in the form of a specific individual, a group, or an organization. Additional parameters that help define the Performers assignment can be added by a modeling tool. |
| InMessage : Message | A Message for the InMessage attribute MUST be entered. This indicates that the Message will be sent at the start of the Task, after the availability of any defined InputSets. A corresponding outgoing Message Flow MAY be shown on the diagram. However, the display of the Message Flow is not required. |
| OutMessage : Message | A Message for the OutMessage attribute MUST be entered. The arrival of this message marks the completion of the Task, which may cause the production of an OutputSet. A corresponding incoming Message Flow MAY be shown on the diagram. However, the display of the Message Flow is not required. |
| Implementation (Web Service Other Unspecified) Web Service : String | This attribute specifies the technology that will be used by the Performers to perform the Task. A Web service is the default technology. |

Script Task Attributes

The following table displays the set of attributes of a Script Task (where the TaskType attribute is set to “Script”), which extends the set of Task attributes (see Table B.16).

Table B.21 - Script Task Attributes

| Attributes | Description |
|------------------------------|--|
| Script (0-1) : String | The modeler MAY include a script that can be run when the Task is performed. If a script is not included, then the Task will act equivalent to a TaskType of None. |

Manual Task Attributes

The following table displays the set of attributes of a Manual Task (where the TaskType attribute is set to “Manual”), which extends the set of Task attributes (see Table B.16):

Table B.22 - Manual Task Attribute

| Attributes | Description |
|----------------------------------|--|
| Performers (0-n) : String | One or more Performers MAY be entered. The Performers attribute defines the human resource that will be performing the Manual Task. The Performers entry could be in the form of a specific individual, a group, or an organization. |

Reference Task Attributes

The following table displays the set of attributes of a Reference Task (where the TaskType attribute is set to “Reference”), which extends the set of Task attributes (see Table B.16).

Table B.23 - Reference Task Attributes

| Attributes | Description |
|-----------------------|--|
| TaskRef : Task | The Task being referenced MUST be identified. The attributes for the Task element can be found in Figure . |

B.7 Gateways

B.7.1 Common Gateway Attributes

The following table displays the attributes common to Gateways, and which extends the set of common Flow Object attributes (see Table B.4).

Table B.24 - Common Gateway Attributes

| Attributes | Description |
|--|--|
| GatewayType (XOR OR Complex AND) XOR : String | GatewayType is by default XOR. The GatewayType MAY be set to OR, Complex, or AND. The GatewayType will determine the behavior of the Gateway, both for incoming and outgoing Sequence Flow, and will determine the internal indicator (as shown in Figure 9.15). |

B.7.2 Exclusive Gateways (XOR)

Data-Based

The following table displays the attributes for an Data-Based Exclusive Gateway. These attributes only apply if the GatewayType attribute is set to XOR. The following attributes extend the set of common Gateway attributes (see Table B.24).

Table B.25 - Data-Based Exclusive Gateway Attributes

| Attributes | Description |
|--|---|
| XORType (Data Event) Data : String | XORType is by default Data. The XORType MAY be set to Event. Since Data-Based XOR Gateways is the subject of this section, the attribute MUST be set to Data for the attributes and behavior defined in this section to apply to the Gateway. |
| MarkerVisible False : Boolean | This attribute determines if the XOR Marker is displayed in the center of the Gateway diamond (an “X”). The marker is displayed if the attribute is True and it is not displayed if the attribute is False. By default, the marker is not displayed. |
| Gates (0-n) : Gate | There MAY be zero or more Gates. Zero Gates are allowed if the Gateway is last object in a Process flow and there are no Start or End Events for the Process. If there are zero or only one incoming Sequence Flow (i.e, the Gateway is acting as a Decision), then there MUST be at least one Gate. In this case, if there is no DefaultGate, then there MUST be at least two Gates. |
| [Gate] OutgoingSequenceFlow : SequenceFlow | Each Gate MUST have an associated Sequence Flow. The Sequence Flow MUST have its Condition attribute set to Expression and MUST have a valid ConditionExpression. The attributes of a Sequence Flow can be found in “Sequence Flow on page 266.” If there is only one Gate (i.e., the Gateway is acting only as a Merge), then Sequence Flow MUST have its Condition set to None. |
| [Gate] Assignments (0-n) : Assignment | One or more assignment expressions MAY be made for each Gate. The Assignment SHALL be performed when the Gate is selected. The details of Assignment is defined in “Assignment on page 268.” |
| DefaultGate (0-1) : Gate | A Default Gate MAY be specified. |
| [Gate] OutgoingSequenceFlow : SequenceFlow | If there is a DefaultGate, then it MUST have an associated Sequence Flow. The Sequence Flow SHALL have the Default Indicator. The Sequence Flow MUST have its Condition attribute set to Default. The attributes of a Sequence Flow can be found in “Sequence Flow on page 266.” |
| [Gate] Assignments (0-n) : Assignment | One or more assignment expressions MAY be made for the DefaultGate. The Assignment SHALL be performed when the DefaultGate is selected. The details of Assignment is defined in “Assignment on page 268.” |

Event-Based

The following table displays the attributes for an Event-Based Exclusive Gateway. These attributes only apply if the GatewayType attribute is set to XOR. The following attributes extend the set of common Gateway attributes (see Table B.24).

Table B.26 - Event-Based Exclusive Gateway Attributes

| Attributes | Description |
|--|---|
| XORType (Data Event) Event : String | XORType is by default Data. The XORType MAY be set to Event. Since Event-Based XOR Gateways is the subject of this section, the attribute MUST be set to Event for the attributes and behavior defined in this section to apply to the Gateway. |
| Gates (2-n) : Gate | There MUST be two or more Gates. (Note that this type of Gateway does not act <i>only</i> as a Merge--it is always a Decision, at least.) |
| [Gate] OutgoingSequenceFlow : SequenceFlow | Each Gate MUST have an associated Sequence Flow. The Sequence Flow MUST have its Condition attribute set to None (there is not an evaluation of a condition expression). The attributes of a Sequence Flow can be found in “Sequence Flow on page 266.” |
| [Gate] Assignments (0-n) : Assignment | One or more assignment expressions MAY be made for each Gate. The Assignment SHALL be performed when the Gate is selected. The details of Assignment is defined in “Assignment on page 268.” |

B.7.3 Inclusive Gateways (OR)

The following table displays the attributes for an Inclusive Gateway¹. These attributes only apply if the GatewayType attribute is set to OR. The following attributes extend the set of common Gateway attributes (see Table B.24).

1. Inclusive Gateways may be updated to include a DefaultGate attribute. This is currently an Open Issue.

Table B.27 - Inclusive Gateway Attributes

| Attributes | Description |
|--|--|
| Gates (0-n) : Gate | There MAY be zero or more Gates. Zero Gates are allowed if the Gateway is last object in a Process flow and there are no Start or End Events for the Process. If there are zero or only one incoming Sequence Flow (i.e, the Gateway is acting as a Decision), then there MUST be at least two Gates. |
| [Gate] OutgoingSequenceFlow : SequenceFlow | Each Gate MUST have an associated Sequence Flow. The Sequence Flow MUST have its Condition attribute set to Expression and MUST have a valid ConditionExpression. The ConditionExpression MUST be unique for all the Gates within the Gateway. The attributes of a Sequence Flow can be found in “Sequence Flow on page 266” If there is only one Gate (i.e., the Gateway is acting only as a Merge), then Sequence Flow MUST have its Condition attribute set to None. |
| [Gate] Assigments (0-n) : Assignment | One or more assignment expressions MAY be made for each Gate. The Assignment SHALL be performed when the Gate is selected. The details of Assignment is defined in “Assignment on page 268.” |
| DefaultGate (0-1) : Gate | A Default Gate MAY be specified. |
| [Gate] OutgoingSequenceFlow : SequenceFlow | If there is a DefaultGate, then it MUST have an associated Sequence Flow. The Sequence Flow SHALL have the Default Indicator. The Sequence Flow MUST have its Condition attribute set to Default. The attributes of a Sequence Flow can be found in “Sequence Flow on page 266.” |
| [Gate] Assigments (0-n) : Assignment | One or more assignment expressions MAY be made for the DefaultGate. The Assignment SHALL be performed when the DefaultGate is selected. The details of Assignment is defined in “Assignment on page 268.” |

B.7.4 Complex Gateways

The following table displays the attributes for a Complex Gateway. These attributes only apply if the GatewayType attribute is set to Complex. The following attributes extend the set of common Gateway attributes (see Table B.24).

Table B.28 - Complex Gateway Attributes

| Attributes | Description |
|--|---|
| Gates (0-n) : Gate | There MAY be zero or more Gates. Zero Gates are allowed if the Gateway is last object in a Process flow and there are no Start or End Events for the Process. If there are zero or only one incoming Sequence Flow, then there MUST be at least two Gates. |
| [Gate] OutgoingSequenceFlow : SequenceFlow | Each Gate MUST have an associated Sequence Flow. Each Gate MUST have an associated Sequence Flow. The Sequence Flow MUST have its Condition attribute set to None. The attributes of a Sequence Flow can be found in “Sequence Flow on page 266.” If there is only one Gate (i.e., the Gateway is acting only as a Merge), then Sequence Flow MUST have its Condition attribute set to None. |
| [Gate] Assignments (0-n) : Assignment | One or more assignment expressions MAY be made for each Gate. The Assignment SHALL be performed when the Gate is selected. The details of Assignment is defined in “Assignment on page 268.” |
| IncomingCondition (0-1) : Expression | If there are Multiple incoming Sequence Flow, an IncomingCondition expression MUST be set by the modeler. This will consist of an expression that can reference Sequence Flow names and or Process Properties (Data). |
| OutgoingCondition (0-1) : Expression | If there are Multiple outgoing Sequence Flow, an OutgoingCondition expression MUST be set by the modeler. This will consist of an expression that can reference (outgoing) Sequence Flow Ids and or Process Properties (Data). |

B.7.5 Parallel Gateways (AND)

The following table displays the attributes for a Parallel Gateway. These attributes only apply if the GatewayType attribute is set to AND (Parallel). The following attributes extend the set of common Gateway attributes (see Table B.24).

Table B.29 - Parallel Gateway Attributes

| Attributes | Description |
|--|---|
| Gates (0-n) : Gate | There MAY be zero or more Gates. Zero Gates are allowed if the Gateway is last object in a Process flow and there are no Start or End Events for the Process. If there are zero or only one incoming Sequence Flow (i.e, the Gateway is acting as a fork), then there MUST be at least two Gates. |
| [Gate] OutgoingSequenceFlow : SequenceFlow | Each Gate MUST have an associated Sequence Flow. The Sequence Flow MUST have its Condition attribute set to None. The attributes of a Sequence Flow can be found in “Sequence Flow on page 266.” |
| [Gate] Assignments (0-n) : Assignment | One or more assignment expressions MAY be made for each Gate. The Assignment SHALL be performed when the Gate is selected. The details of Assignment is defined in “Assignment on page 268.” |

B.8 Swimlanes (Pools and Lanes)

B.8.1 Common Swimlane Attributes

The following table displays a set of common attributes for Swimlanes (Pools and Lanes), and which extends the set of common graphical object attributes (see Table B.3).

Table B.30 - Common Swimlane Attributes

| Attributes | Description |
|----------------------|--|
| Name : String | Name is an attribute that is text description of the Swimlane. |

B.8.2 Pool

The following table displays the identified attributes of a Pool, and which extends the set of common Swimlane attributes (see Table B.30).

Table B.31 - Pool Attributes

| Attributes | Description |
|---------------------------------------|--|
| Process (0-1) : Process | The Process attribute defines the Process that is contained within the Pool. Each Pool MAY have a Process. The attributes for a Process can be found in “Process Attributes on page 242.” |
| Participant : Participant | The Modeler MUST define the Participant for a Pool. The Participant can be either a Role or an Entity. This defines the role that a particular Entity or Role the Pool will play in a Diagram that includes collaboration. The attributes for a Participant can be found in “Participant on page 270.” |
| Lanes (1-n) : Lane | There MUST one or more Lanes within a Pool. If there is only one Lane, then that Lane shares the name of the Pool and only the Pool name is displayed. If there is more than one Lane, then each Lane has to have its own name and all names are displayed. The attributes for a Lane can be found in “Lane on page 90.” |
| BoundaryVisible True : Boolean | This attribute defines if the rectangular boundary for the Pool is visible. Only one Pool in the Diagram MAY have the attribute set to False. |

B.8.3 Lane

The following table displays the identified attributes of a Lane, and which extends the set of common Swimlane attributes (see Table B.30).

Table B.32 - Lane Attributes

| Attributes | Description |
|--------------------------------|---|
| ParentPool : Pool | The Parent Pool MUST be specified. There can be only one Parent. The attributes for a Pool can be found in “Swimlanes (Pools and Lanes) on page 262.” |
| ParentLane (0-1) : Lane | ParentLane is an optional attribute that is used if the Lane is nested within another Lane. Nesting can be multi-level, but only the immediate parent is specified. |

B.9 Artifacts

B.9.1 Common Artifact Attributes

The following table displays the identified attributes common to Artifacts, and which extends the set of common graphical object attributes (see Table B.3).

Table B.33 - Common Artifact Attributes

| Attributes | Description |
|---|--|
| ArtifactType (DataObject Group Annotation) DataObject : String | The ArtifactType MAY be set to DataObject, Group, or Annotation. The ArtifactType list MAY be extended to include new types. |
| Pool (0-1) : Pool | A Pool MAY be added to identify its location. Artifacts, such as Annotations, can be placed outside of any Pool. Also, a Group may stretch across multiple Pools. The attributes for a Pool can be found in “Pool on page 87.” |
| Lanes (0-n) : Lane | If the Pool has more than one Lane, then a Lane MUST be added. There MAY be multiple Lanes listed. The attributes for a Lane can be found in “Lane on page 90.” |

B.9.2 Data Object

The following table displays the attributes for Data Objects, and which extends the set of common Artifact attributes (see Table B.33). These attributes only apply if the ArtifactType attribute is set to DataObject:

Table B.34 - Data Object Attributes

| Attributes | Description |
|--|--|
| Name : String | Name is an attribute that is text description of the object. |
| State (0-1) : String | State is an optional attribute that indicates the impact the Process has had on the Data Object. Multiple Data Objects with the same name MAY share the same state within one Process. |
| Properties (0-n) : Properties | Modeler-defined Properties MAY be added to a Data Object. The fully delineated name of these properties are “<process name>.<task name>.<property name>” (e.g., “Add Customer.Review Credit Report.Score”). Further details about the definition of a Property can be found in “Property on page 270.” |
| RequiredForStart True : Boolean | The default value for this attribute is True. This means that the Input is required for the activity to start. If set to False, then the activity MAY start within the input, but MAY accept the input (more than once) after the activity has started. |
| ProducedAtCompletion True : Boolean | The default value for this attribute is True. This means that the Output will be produced when the activity has been completed. If set to False, then the activity MAY produce the output (more than once) before it has completed. |

B.9.3 Text Annotation

The following table displays the attributes for Annotations, and which extends the set of common Artifact attributes (see Table B.33). These attributes only apply if the `ArtifactType` attribute is set to Annotation.

Table B.35 - Text Annotation Attributes

| Attributes | Description |
|----------------------|--|
| Text : String | Text is an attribute that is text that the modeler wishes to communicate to the reader of the Diagram. |

B.9.4 Group

The following table displays the attributes for Groups, and which extends the set of common Artifact attributes (see Table B.33). These attributes only apply if the `ArtifactType` attribute is set to Group.

Table B.36 - Group Attributes

| Attributes | Description |
|----------------------------|--|
| Name (0-1) : String | Name is an optional attribute that is text description of the Group. |

B.10 Graphical Connecting Objects

B.10.1 Common Connecting Object Attributes

The following table displays the set of attributes common to Connecting Objects (Sequence Flow, Message Flow, and Association), and which extends the set of common graphical object attributes (see Table B.3).

Table B.37 - Common Connecting Object Attributes

| Attributes | Description |
|------------------------|---|
| Name : String | Name is an attribute that is text description of the object. |
| Source : Object | Source is an attribute that identifies which Flow Object the Connecting Object is connected <i>from</i> . Note: there are restrictions as to what objects Sequence Flow and Message Flow can connect. Refer to the Sequence Flow Connections section and the Message Flow Connections section for each Flow Object, Swimlane, and Artifact. |
| Target : Object | Target is an attribute that identifies which Flow Object the Connecting Object is connected <i>to</i> . Note: there are restrictions as to what objects Sequence Flow and Message Flow can connect. Refer to the Sequence Flow Connections section and the Message Flow Connections section for each Flow Object, Swimlane, and Artifact. |

B.10.2 Sequence Flow

The following table displays the set of attributes of a Sequence Flow, and which extends the set of common Connecting Object attributes (see Table B.37).

Table B.38 - Sequence Flow Attributes

| Attributes | Description |
|--|--|
| <p>ConditionType (None Expression Default) None : String</p> | <p>By default, the ConditionType of a Sequence Flow is None. This means that there is no evaluation at runtime to determine whether or not the Sequence Flow will be used. Once a Token is ready to traverse the Sequence Flow (i.e., the Source is an activity that has completed), then the Token will do so. The normal, uncontrolled use of Sequence Flow, in a sequence of activities, will have a None ConditionType (see Figure 10.1). A None ConditionType MUST NOT be used if the Source of the Sequence Flow is an Exclusive Data-Based or Inclusive Gateway.</p> <p>The ConditionType attribute MAY be set to Expression if the Source of the Sequence Flow is a Task, a Sub-Process, or a Gateway of type Exclusive-Data-Based or Inclusive.</p> <p>If the ConditionType attribute is set to Expression, then a condition marker SHALL be added to the line if the Sequence Flow is outgoing from an activity (see Figure 10.2). However, a condition indicator MUST NOT be added to the line if the Sequence Flow is outgoing from a Gateway.</p> <p>An Expression ConditionType MUST NOT be used if the Source of the Sequence Flow is an Event-Based Exclusive Gateway, a Complex Gateway, a Parallel Gateway, a Start Event, or an Intermediate Event. In addition, an Expression ConditionType MUST NOT be used if the Sequence Flow is associated with the Default Gate of a Gateway.</p> <p>The ConditionType attribute MAY be set to Default only if the Source of the Sequence Flow is an activity or an Exclusive Data-Based Gateway. If the ConditionType is Default, then the Default marker SHALL be displayed (see Figure 10.3).</p> |
| <p>[ConditionType is set to Expression only] ConditionExpression : Expression</p> | <p>If the ConditionType attribute is set to Expression, then the ConditionExpression attribute MUST be defined as a valid expression. The expression will be evaluated at runtime. If the result of the evaluation is TRUE, then a Token will be generated and will traverse the Sequence--Subject to any constraints imposed by a Source that is a Gateway.</p> |
| <p>Quantity 1 : Integer</p> | <p>The default value is 1. The value MUST NOT be less than 1. This attribute defines the number of Tokens that will be generated down the Sequence Flow.</p> |

B.10.3 Message Flow

The following table displays the identified attributes of a Message Flow, and which extends the set of common Connecting Object attributes (see Table B.37).

Table B.39 - Message Flow Attributes

| Attributes | Description |
|--------------------------------|---|
| Message (0-1) : Message | Message is an optional attribute that identifies the Message that is being sent. The attributes of a Message can be found in “Message on page 269.” |

B.10.4 Association

The following table displays the identified attributes of a Association, and which extends the set of common Connecting Object attributes (see Table B.37).

Table B.40 - Association Attributes

| Attributes | Description |
|--|--|
| Direction (None To From Both) None : String | Direction is an attribute that defines whether or not the Association shows any directionality with an arrowhead. The default is None (no arrowhead). A value of To means that the arrowhead SHALL be at the Source object. A value of From means that the arrowhead SHALL be at the Target Artifact. A value of Both means that there SHALL be an arrowhead at both ends of the Association line. |

B.11 Supporting Types

B.11.1 Assignment

The following table displays the set of attributes of an Assignment, which is used in the definition of attributes for Process, Activities, Events, Gateways, and Gates.

Table B.41 - Assignment Attributes

| Attributes | Description |
|---|--|
| To : Property | The target for the Assignment MUST be a Property of the Process or the activity itself. |
| From : Expression | The Expression MUST be made up of a combination of Values, Properties, and Attributes, which are separated by operators such as add or multiply. The expression language is defined in the ExpressionLanguage attribute of the Business Process Diagram - see “Business Process Diagram Attributes on page 241.” |
| AssignTime (0-1) (Start End) Start : String | An Assignment MAY have a AssignTime setting. If the Object is an activity (Task, Sub-Process, or Process), then the Assignment MUST have an AssignTime. A value of Start means that the assignment SHALL occur at the start of the activity. This can be used to assign the higher-level (global) Properties of the Process to the (local) Properties of the activity as an input to the activity. A value of End means that the assignment SHALL occur at the end of the activity. This can be used to assign the (local) Properties of the activity to the higher-level (global) Properties of the Process as an output to the activity. |

B.11.2 Entity

The following table displays the set of attributes of an Entity, which is used in the definition of attributes for a Participant.

Table B.42 - Entity Attributes

| Attributes | Description |
|----------------------|--|
| Name : String | Name is an attribute that is text description of the Entity. |

B.11.3 Expression

The following table displays the set of attributes of an Expression, which is used in the definition of attributes for Start Event, Intermediate Event, Activity, Complex Gateway, and Sequence Flow.

Table B.43 - Expression Attributes

| Attributes | Description |
|----------------------------|---|
| Expression : String | An Expression MUST be entered to provide a mathematical expression to be either tested as True or False or to be evaluated to update the value of Properties (e.g., assignment). |

B.11.4 Message

The following table displays the set of attributes of a Message, which is used in the definition of attributes for a Start Event, End Event, Intermediate Event, Task, and Message Flow.

Table B.44 - Message Attributes

| Attributes | Description |
|------------------------------------|--|
| Name : String | Name is an attribute that is text description of the Message. |
| Properties (0-n) : Property | Multiple Properties MAY entered for the Message. The attributes of a Property can be found in “Property on page 270.” |
| From : Participant | This defines the source of the Message. The attributes for a Participant can be found in “Participant on page 270.” |
| To : Participant | This defines the target of the Message. The attributes for a Participant can be found in “Participant on page 270.” |

B.11.5 Object

The following table displays the set of attributes of an Object, which is used in the definition of attributes for all graphical elements.

Table B.45 - Object Attributes

| Attributes | Description |
|--------------------|---|
| Id : String | The Id attribute provides a unique identifier for all objects on a diagram. That is, each object MUST have a different value for the ObjectId attribute. |

B.11.6 Participant

The following table displays the set of attributes of a Participant, which is used in the definition of attributes for a Pool, Message, and Web service.

Table B.46 - Participant Attributes

| Attributes | Description |
|---|--|
| ParticipantType (Role Entity) Role : String | Each Property has a Name (e.g., name="Customer Name"). |
| [ParticipantType = "Role" only] Role (0-1) : Role | If the ParticipantType = Role, then a Role MUST be identified. The attributes for a Role can be found in "Role on page 270." |
| [ParticipantType = "Entity" only] Entity (0-1) : Entity | If the ParticipantType = Entity, then an Entity MUST be identified. The attributes for an Entity can be found in "Entity on page 268." |

B.11.7 Property

The following table displays the set of attributes of a Property, which is used in the definition of attributes for a Process and common activity attributes:

Table B.47 - Property Attributes

| Attributes | Description |
|---|--|
| Name : String | Each Property has a Name (e.g., name="Customer Name"). |
| Type : String | Each Property has a Type (e.g., type="String"). A Property may be of type Set, which allows child Properties. |
| [Type = "Set" only] Correlation (0-1) False : Boolean | If the ConditionType attribute is set to Expression, then the ConditionExpression attribute MUST be defined. Otherwise, it is not valid. This attribute is included for mapping to BPEL4WS. The Property will map to a <i>correlationSet</i> and the child Properties will be <i>properties</i> of that <i>correlationSet</i> . |

B.11.8 Role

The following table displays the set of attributes of a Role, which is used in the definition of attributes for a Participant.

Table B.48 - Role Attributes

| Attributes | Description |
|----------------------|--|
| Name : String | Name is an attribute that is text description of the Role. |

B.11.9 Rule

The following table displays the set of attributes of a Rule, which is used in the definition of attributes for Start Event and Intermediate Event.

Table B.49 - Rule Attributes

| Attributes | Description |
|--|--|
| Name : String | Name is an attribute that is text description of the Rule. |
| RuleExpression (0-1) : Expression | A RuleExpression May be entered. In some cases the Rule itself will be stored and maintained in a separate application (e.g., a Rules Engine). The attributes of an Expression can be found in “Expression on page 269.” |

B.11.10 Transaction

The following table displays the set of attributes of a Transaction, which is used in the definition of attributes for a Sub-Process.

Table B.50 - Transaction Attributes

| Attributes | Description |
|--|--|
| TransactionId : String | The TransactionId attribute provides an identifier for the Transactions used within a diagram. |
| TransactionProtocol : String | This identifies the Protocol (e.g., WS-Transaction or BTP) that will be used to control the transactional behavior of the Sub-Process. |
| TransactionMethod (Compensate Store Image) Compensate : String | TransactionMethod is an attribute that defines the technique that will be used to undo a Transaction that has been cancelled. The default is Compensate, but the attribute MAY be set to Store or Image. |

B.11.11 Web Service

The following table displays the set of attributes of an Web Service, which is used in the definition of attributes for Message Start Event, Message Intermediate Event, Message End Event, Receive Task, Send Task, Service Task, and User Task.

Table B.51 - Web Service Attributes

| Attributes | Description |
|----------------------------------|--|
| Participant : Participant | A Participant for the Web Service MUST be entered. Note, this will map to the BPEL4WS <i>partnerLink</i> . The attributes for a Participant can be found in “Participant on page 270.” |
| Interface : String | (aka portType) An Interface for the Web Service MUST be entered. |
| Operation : String | One or more Operations for the Web Service MUST be entered. |

Annex C (informative)

Glossary

A

| | |
|--------------------------|---|
| Activity: | An activity is a generic term for work that company or organization performs via business processes. An activity can be atomic or non-atomic (compound). The types of activities that are a part of a Process Model are: Process, Sub-Process, and Task. |
| Abstract Process: | An Abstract Process represents the interactions between a private business process and another process or participant. |
| AND-Join: | (from the WfMC Glossary ¹) An AND-Join is a point in the <u>Process</u> where two or more parallel executing activities converge into a single common thread of <u>Sequence Flow</u> . See “Join.” |
| AND-Split: | (from the WfMC Glossary ²) An AND-Split is a point in the <u>Process</u> where a single thread of <u>Sequence Flow</u> splits into two or more threads which are executed in parallel within the <u>Process</u> , allowing multiple activities to be executed simultaneously. See “Fork.” |
| Arbitrary Cycles: | (From the Workflow Patterns Initiative ²). Pattern #11: A point in a workflow process when one or more activities can be done repeatedly ³ . |
| Artifact: | An Artifact is a graphical object that provides supporting information about the Process or elements within the Process. However, it does not directly affect the flow of the Process. BPMN has standardized the shape of a Data Object. Other examples of Artifacts include critical success factors and milestones. |

-
1. The underlined terms in this definition were changed from the original definition. “Process” is used in place of “workflow.” “Sequence Flow” is used in place of “control.”
 2. <http://tmitwww.tm.tue.nl/research/patterns/patterns.htm>
 3. http://tmitwww.tm.tue.nl/research/patterns/arbitrary_cycles.htm

Association: An Association is a dotted graphical line that is used to associate information and Artifacts with Flow Objects. Text and graphical non-Flow Objects can be associated with the Flow Objects and Flow.

Atomic Activity: An atomic activity is an activity not broken down to a finer level of Process Model detail. It is a leaf in the tree-structure hierarchy of Process activities. Graphically it will appear as a Task in BPMN.

B

Business Analyst: A Business Analyst is an individual within an organization who defines, manages, or monitors Business Processes. They are usually distinguished from the IT specialists or programmers who implement the Business Process within a BPMS.

Business Process: A Business Process is displayed within a Business Process Diagram (BPD). A Business Process contains one or more Processes.

Business Process Diagram: A Business Process Diagram (BPD) is the diagram that is specified by BPMN. A BPD uses the graphical elements and that semantics that support these elements as defined in this specification.

Business Process Management: Business Process Management (BPM) encompasses the discovery, design, and deployment of business processes. In addition, BPM includes the executive, administrative, and supervisory control of those processes⁴.

BPM System: The technology that enables BPM.

C

Cancel Activity: (From the Workflow Patterns Initiative⁵). Pattern #20: An enabled activity is disabled, i.e. a thread waiting for the execution of an activity is removed⁶.

Cancel Case: (From the Workflow Patterns Initiative²). Pattern #21: A case, i.e.workflow instance, is removed completely⁷.

Choreography: Choreography is an ordered sequence of B2B message exchanges.

4. From "Business Process Management: the Third Wave," by Howard Smith and Peter Fingar, pg 4. 2003, Meghan-Kiffer Press. ISBN 0-929652-33-9

5. <http://tmitwww.tm.tue.nl/research/patterns/patterns.htm>

6. http://tmitwww.tm.tue.nl/research/patterns/cancel_activity.htm

7. http://tmitwww.tm.tue.nl/research/patterns/cancel_case.htm

| | |
|-------------------------------|--|
| Collaboration: | Collaboration is the act of sending messages between any two Participants in a BPMN model. The two Participants represent two separate BPML processes. |
| Collaboration Process: | A Collaboration Process depicts the interactions between two or more business entities. |
| Collapsed Sub-Process: | A Collapsed Sub-Process is a Sub-Process that hides its flow details. The Collapsed Sub-Process object uses a marker to distinguish it as a Sub-Process, rather than a Task. The marker is a small square with a plus sign (+) inside. |
| Compensation Flow: | Compensation Flow is defines the set of activities that are performed during the roll-back of a transaction to compensate for activities that were performed during the Normal Flow of the Process. Compensation can also be called from a Compensate End or Intermediate Event. |
| Compound Activity: | A compound activity is an activity that has detail that is defined as a flow of other activities. It is a branch (or trunk) in the tree-structure hierarchy of Process activities. Graphically, it will appear as a Process or Sub-Process in BPMN. |
| Controlled Flow: | Flow that proceeds from one Flow Object to another, via a Sequence Flow link, but is subject to either conditions or dependencies from other flow as defined by a Gateway. Typically, this is seen as a Sequence flow between two activities, with a conditional indicator (mini-diamond) or a Sequence Flow connected to a Gateway. |

D

| | |
|------------------|--|
| Decision: | Decisions are locations within a business process where the Sequence Flow can take two or more alternative paths. This is basically the “fork in the road” for a process. For a given performance (or instance) of the process, only one of the forks can be taken. A Decision is a type of Gateway. See “Or-Split.” |
|------------------|--|

Deferred Choice:

(From the Workflow Patterns Initiative⁸). Pattern #17: A point in the workflow process where one of several branches is chosen. In contrast to the XOR-split, the choice is not made explicitly (e.g. based on data or a decision) but several alternatives are offered to the environment. However, in contrast to the AND-split, only one of the alternatives is executed. This means that once the environment activates one of the branches the other alternative branches are withdrawn. It is important to note that the choice is delayed until the processing in one of the alternative branches is actually started, i.e. the moment of choice is as late as possible⁹.

Discriminator:

(From the Workflow Patterns Initiative¹). Pattern #8: The discriminator is a point in a workflow process that waits for a number of incoming branches to complete before activating the subsequent activity. From that moment on it waits for all remaining branches to complete and "ignores" them. Once all incoming branches have been triggered, it resets itself so that it can be triggered again¹⁰.

E**End Event:**

As the name implies, the End Event indicates where a process will end. In terms of Sequence Flow, the End Event ends the flow of the Process, and thus, will not have any outgoing Sequence Flow. An End Event can have a specific Result that will appear as a marker within the center of the End Event shape. End Event Results are Message, Error, Compensation, Link, and Multiple. The End Event shares the same basic shape of the Start Event and Intermediate Event, a circle, but is drawn with a thick single line

Event Context:

An Event Context is the set of activities that can be interrupted by an exception (Intermediate Event). This can be one activity or a group of activities in an expanded Sub-Process.

Exception:

An Exception is an event that occurs during the performance of the process that causes Normal Flow of the process to be diverted exclusively from Normal Flow. Exceptions can be generated by a time out, fault, message, etc.

8. <http://tmitwww.tm.tue.nl/research/patterns/patterns.htm>

9. http://tmitwww.tm.tue.nl/research/patterns/deferred_choice.htm

10. <http://tmitwww.tm.tue.nl/research/patterns/discriminator.htm>

| | |
|------------------------------|--|
| Exception Flow: | Exception Flow is a set of Sequence Flow that originates from an Intermediate Event that is attached to the boundary of an activity. The Process will not traverse this flow unless an Exception occurs during the performance of that activity (through an Intermediate Event). |
| Exclusive Choice: | (From the Workflow Patterns Initiative ¹¹). Pattern #4: A point in the workflow process where, based on a decision or workflow control data, one of several branches is chosen ¹² . |
| Expanded Sub-Process: | An Expanded Sub-Process is a Sub-Process that exposes its flow detail within the context of its Parent Process. It will maintain its rounded rectangle shape, but will be enlarged to a size sufficient to display the Flow Objects within. |

F

| | |
|---------------------|--|
| Flow: | A Flow is a graphical line connecting two objects in a BPD. There are two types of Flow: Sequence Flow and Message Flow, each with their own line style. Flow is also used in a generic sense (and lowercase) to describe how Tokens will traverse Sequence Flow from the Start Event to an End Event. |
| Flow Object: | A Flow Object is one of the set of following graphical objects: Events, Activities, and Gateways. |
| Fork: | A fork is a point in the Process where a single flow is divided into two or more Flow. It is a mechanism that will allow activities to be performed concurrently, rather than sequentially. BPMN uses multiple outgoing Sequence Flow or an Parallel Gateway to perform a Fork. See “AND-Split.” |

I

| | |
|------------------------------|--|
| Implicit Termination: | (From the Workflow Patterns Initiative ¹³). Pattern #12: A given subprocess should be terminated when there is nothing else to be done. In other words, there are no active activities in the workflow and no other activity can be made active (and at the same time the workflow is not in deadlock) ¹⁴ . |
|------------------------------|--|

11. <http://tmitwww.tm.tue.nl/research/patterns/patterns.htm>
12. http://tmitwww.tm.tue.nl/research/patterns/exclusive_choice.htm
13. <http://tmitwww.tm.tue.nl/research/patterns/patterns.htm>
14. http://tmitwww.tm.tue.nl/research/patterns/implicit_termination.htm

Interleaved Parallel Routing: (From the Workflow Patterns Initiative¹). Pattern #18: A set of activities is executed in an arbitrary order: Each activity in the set is executed, the order is decided at run-time, and no two activities are executed at the same moment (i.e. no two activities are active for the same workflow instance at the same time)¹⁵.

Intermediate Event: An Intermediate Event is an event that occurs after a Process has been started. It will affect the flow of the process, but will not start or (directly) terminate the process. An Intermediate Event will show where messages or delays are expected within the Process, disrupt the Normal Flow through exception handling, or show the extra flow required for compensating a transaction. The Intermediate Event shares the same basic shape of the Start Event and End Event, a circle, but is drawn with a thin double line.

J

Join: A Join is a point in the Process where two or more parallel Sequence Flow are combined into one Sequence Flow. BPMN uses an Parallel Gateway to perform a Join. See “AND-Join.”

L

Lane: An Lane is a sub-partition within a Pool and will extend the entire length of the Pool, either vertically or horizontally. Lanes are used to organize and categorize activities within a Pool. The meaning of the Lanes is up to the modeler.

M

Merge: A Merge is a point in the process where two or more alternative Sequence Flow are combined into one Sequence Flow. BPMN uses multiple incoming Sequence Flow or an XOR Gateway to perform a Merge. See “OR-Join.”

Message: A Message is the object that is transmitted through a Message Flow. The Message will have an identity that can be used for alternative branching of a Process through the Event-Based Exclusive Gateway.

15. http://tmitwww.tn.tue.nl/research/patterns/interleaved_parallel_routing.htm

| | |
|----------------------------|--|
| Message Flow: | A Message Flow is a dashed line that is used to show the flow of messages between two entities that are prepared to send and receive them. In BPMN, two separate Pools in the Diagram will represent the two entities. |
| Milestone: | (From the Workflow Patterns Initiative ¹⁶). Pattern #19: The enabling of an activity depends on the case being in a specified state, i.e.the activity is only enabled if a certain milestone has been reached which did not expire yet. Consider three activities A, B, and C. Activity A is only enabled if activity B has been executed and C has not been executed yet, i.e.A is not enabled before the execution B and A is not enabled after the execution C ¹⁷ . |
| Multiple Choice: | (From the Workflow Patterns Initiative ¹). Pattern #6: A point in the workflow process where, based on a decision or workflow control data, one or more branches are chosen ¹⁸ . |
| Multiple Instances: | (From the Workflow Patterns Initiative ¹). Patterns #13-16: There are four defined patterns. 1. For one case an activity is enabled multiple times. The number of instances of a given activity for a given case is known at design time. 2. For one case an activity is enabled multiple times. The number of instances of a given activity for a given case is variable and may depend on characteristics of the case or availability of resources, but is known at some stage during runtime, before the instances of that activity have to be created. 3. For one case an activity is enabled multiple times. The number of instances of a given activity for a given case is not known during design time, nor it is known at any stage during runtime, before the instances of that activity have to be created. 4 For one case an activity is enabled multiple times. The number of instances may not be known at design time. After completing all instances of that activity another activity has to be started ¹⁹ . |
| Multiple Merge: | (From the Workflow Patterns Initiative ¹). Pattern #7: Multi-merge is a point in a workflow process where two or more branches reconverge without synchronization. If more than one branch gets activated, possibly concurrently, the activity following the merge is started once for every incoming branch that gets activated ²⁰ . |

16. <http://tmitwww.tm.tue.nl/research/patterns/patterns.htm>

17. <http://tmitwww.tm.tue.nl/research/patterns/milestone.htm>

18. http://tmitwww.tm.tue.nl/research/patterns/multiple_choice.htm

19. <http://tmitwww.tm.tue.nl/research/patterns/patterns.htm>

N

N-out-of-M-Join:

(From the Workflow Patterns Initiative¹). Pattern #9: N-out-of-M Join is a point in a workflow process where M parallel paths converge into one. The subsequent activity should be activated once N paths have completed. Completion of all remaining paths should be ignored. Similarly to the discriminator, once all incoming branches have “fired”, the join resets itself so that it can fire again²¹.

Normal Flow:

Normal Flow is the flow that originates from a Start Event and continues through activities via alternative and parallel paths until it ends at an End Event.

O

OR-Join:

(from the WfMC Glossary²²) An Or-Join is a point in the Process where two or more alternative activity(s) Process branches re-converge to a single common activity as the next step within the Process. (As no parallel activity execution has occurred at the join point, no synchronization is required.) See “Merge.”

OR-Split:

(from the WfMC Glossary¹) An OR-Split is a point in the Process where a single thread of Sequence Flow makes a decision upon which branch to take when encountered with multiple alternative Process branches. See “Decision.”

P

Parallel Split:

(From the Workflow Patterns Initiative²³). Pattern #2: Parallel split is required when two or more activities need to be executed in parallel. Parallel split is easily supported by most workflow engines except for the most basic scheduling systems that do not require any degree of concurrency²⁴.

Parent Process:

A Parent Process is the Process that holds a Sub-Process within its boundaries.

20. http://tmitwww.tm.tue.nl/research/patterns/multiple_merge.htm

21. http://tmitwww.tm.tue.nl/research/patterns/n-out-of-m_join.htm

22. The underlined terms in this definition were changed from the original definition. “Process” is used in place of “workflow.” “Sequence Flow” is used in place of “control.”

23. <http://tmitwww.tm.tue.nl/research/patterns/patterns.htm>

24. http://tmitwww.tm.tue.nl/research/patterns/parallel_split.htm

| | |
|----------------------------------|---|
| Participant: | A Participant is a business entity (e.g., a company, company division, or a customer) or a business role (e.g., a buyer or a seller), which controls or is responsible for a business process. If Pools are used, then a Participant would be associated with one Pool. |
| Pool: | A Pool represents a Participant in a Process. It also acts as a “swimlane” and a graphical container for partitioning a set of activities from other Pools, usually in the context of B2B situations. It is a square-cornered rectangle that is drawn with a solid single line. A Pool acts as the container for the Sequence Flow between activities. The Sequence Flow can cross the boundaries between Lanes of a Pool, but cannot cross the boundaries of a Pool. The interaction between Pools, e.g., in a B2B context, is shown through Message Flow. |
| Private Business Process: | A private business process is internal to a specific organization and is the type of process that has been generally called a workflow or BPM process. A single private business process will map to a single BPML document. |
| Process: | A Process is any activity performed within a company or organization. In BPMN a Process is depicted as a network of Flow Objects, which are a set of other activities and the controls that sequence them. |
| R | |
| Result: | A Result is consequence of reaching an End Event. Results can be of different types, including: Message, Error, Compensation, Link, and Multiple. |
| S | |
| Sequence: | (From the Workflow Patterns Initiative ²⁵). Pattern #1: Sequence is the most basic workflow pattern. It is required when there is a dependency between two or more tasks so that one task cannot be started (scheduled) before another task is finished ²⁶ . |
| Sequence Flow: | A Sequence Flow is a solid graphical line that is used to show the order that activities will be performed in a Process. Each Flow has only one source and only one target. |

25. <http://tmitwww.tm.tue.nl/research/patterns/patterns.htm>

26. <http://tmitwww.tm.tue.nl/research/patterns/sequence.htm>

| | |
|----------------------------|--|
| Simple Merge: | (From the Workflow Patterns Initiative ²⁷ “ http://tmitwww.tm.tue.nl/research/patterns/patterns.htm ” on page 281). Pattern #5: A point in the workflow process where two or more alternative branches come together without synchronization. In other words the merge will be triggered once any of the incoming transitions are triggered ²⁷ . |
| Start Event: | A Start Event indicates where a particular Process will start. In terms of Sequence Flow, the Start Event starts the flow of the Process, and thus, will not have any incoming Sequence Flow. A Start Event can have a Trigger that indicates how the Process starts: Message, Timer, Rule, Link, or Multiple. The Start Event shares the same basic shape of the Intermediate Event and End Event, a circle, but is drawn with a single thin line |
| Sub-Process: | A Sub-Process is Process that is included within another Process. The Sub-Process can be in a collapsed view that hides its details. A Sub-Process can be in an expanded view that shows its details within the view of the Process in which it is contained. A Sub-Process shares the same shape as the Task, which is a rectangle that has rounded corners. |
| Swimlane: | A Swimlane is a graphical container for partitioning a set of activities from other activities. BPMN has two different types of Swimlanes. See “Pool” and “Lane.” |
| Synchronizing Join: | (From the Workflow Patterns Initiative ²⁸). Pattern #10: A point in the workflow process where multiple paths converge into one single thread. If more than one path is taken, synchronization of the active threads needs to take place. If only one path is taken, the alternative branches should reconverge without synchronization ²⁹ . |
| Synchronization: | (From the Workflow Patterns Initiative ³⁰ “ http://tmitwww.tm.tue.nl/research/patterns/patterns.htm ” on page 281). Pattern #3: Synchronization is required when an activity can be started only when two parallel threads complete ³⁰ . |

27. http://tmitwww.tm.tue.nl/research/patterns/simple_merge.htm

28. <http://tmitwww.tm.tue.nl/research/patterns/patterns.htm>

29. http://tmitwww.tm.tue.nl/research/patterns/synchronizing_join.htm

30. <http://tmitwww.tm.tue.nl/research/patterns/synchronization.htm>

T

Task: A Task is an atomic activity that is included within a Process. A Task is used when the work in the Process is not broken down to a finer level of Process Model detail. Generally, an end-user and/or an application are used to perform the Task when it is executed. A Task object shares the same shape as the Sub-Process, which is a rectangle that has rounded corners.

Token: A Token is a descriptive construct used to describe how the flow of a process will proceed at runtime. By tracking how the Token traverses the Flow Objects, gets diverted through alternative paths, and gets split into parallel paths, the normal Sequence Flow should be completely definable. A Token will have a unique identity that can be used to separate multiple Tokens that may exist because of concurrent process instances or the splitting of the Token for parallel processing within a single process instance.

Transaction: A Transaction is a set of coordinated activities carried out by independent, loosely-coupled systems in accordance with a contractually defined business relationship. This coordination leads to an agreed, consistent, and verifiable outcome across all participants.

Trigger: A Trigger is a mechanism that signals the start of a business process. Triggers are associated with a Start Events and Intermediate Events and can be of the type: Message, Timer, Rule, Link, and Multiple.

U

Uncontrolled Flow: Flow that proceeds, unrestricted, from one Flow Object to another, via a Sequence Flow link, without any dependencies on another flow or any conditional expressions. Typically, this is seen as a Sequence flow between two activities, without a conditional indicator (mini-diamond) or any intervening Gateway.

